

KIT 3 EXPANSION KIT
BAE-E3-3001

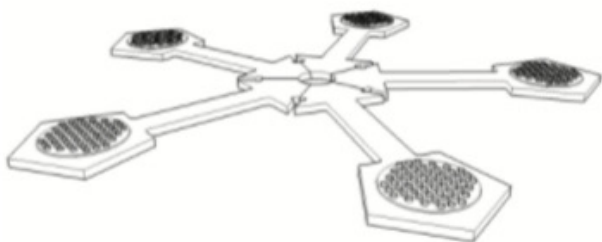

KIT 3 EXPANSION KIT
SHOWN ASSEMBLED WITH KIT 3
CAN BE USED EITHER WAY UP

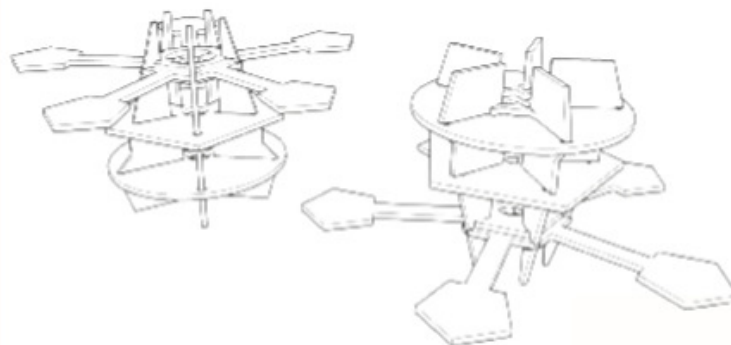

KIT 3 BASE PLATE ATTACHMENT

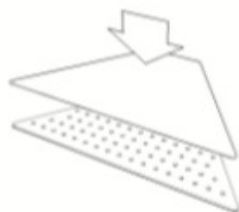

STEP 1
Remove backing from one side of the double-sided tape and attach to the underside of a Base Plate

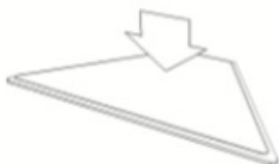

STEP 2
Check alignment to ensure the tape is centralised on the Base Plate and then push firmly

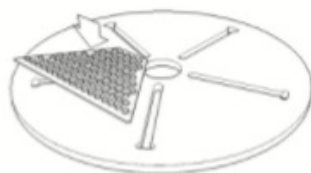

STEP 3
Remove the backing from the underside of the double-sided tape. Turn over and hold the Base Plate just above the surface of the circular or pentagon shaped base

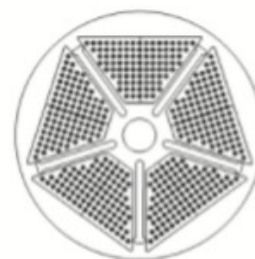

STEP 4
Centralise the Base Plate and ensure there is a small and even gap between the edge of the Base Plate and the side of the slots in the base. Press down firmly to secure

BASE ACE

KIT 3

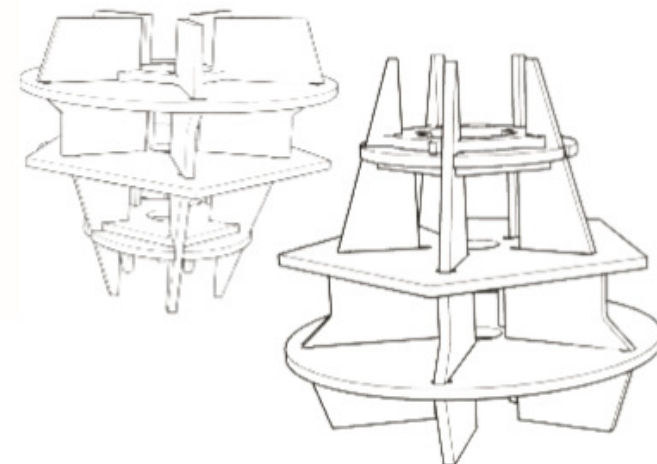

ASSEMBLY INSTRUCTIONS

BAB-K3-3001

ASSEMBLY INSTRUCTIONS

Base Ace Kit 3 BAB-K3-3001

BASE ACE

Contents

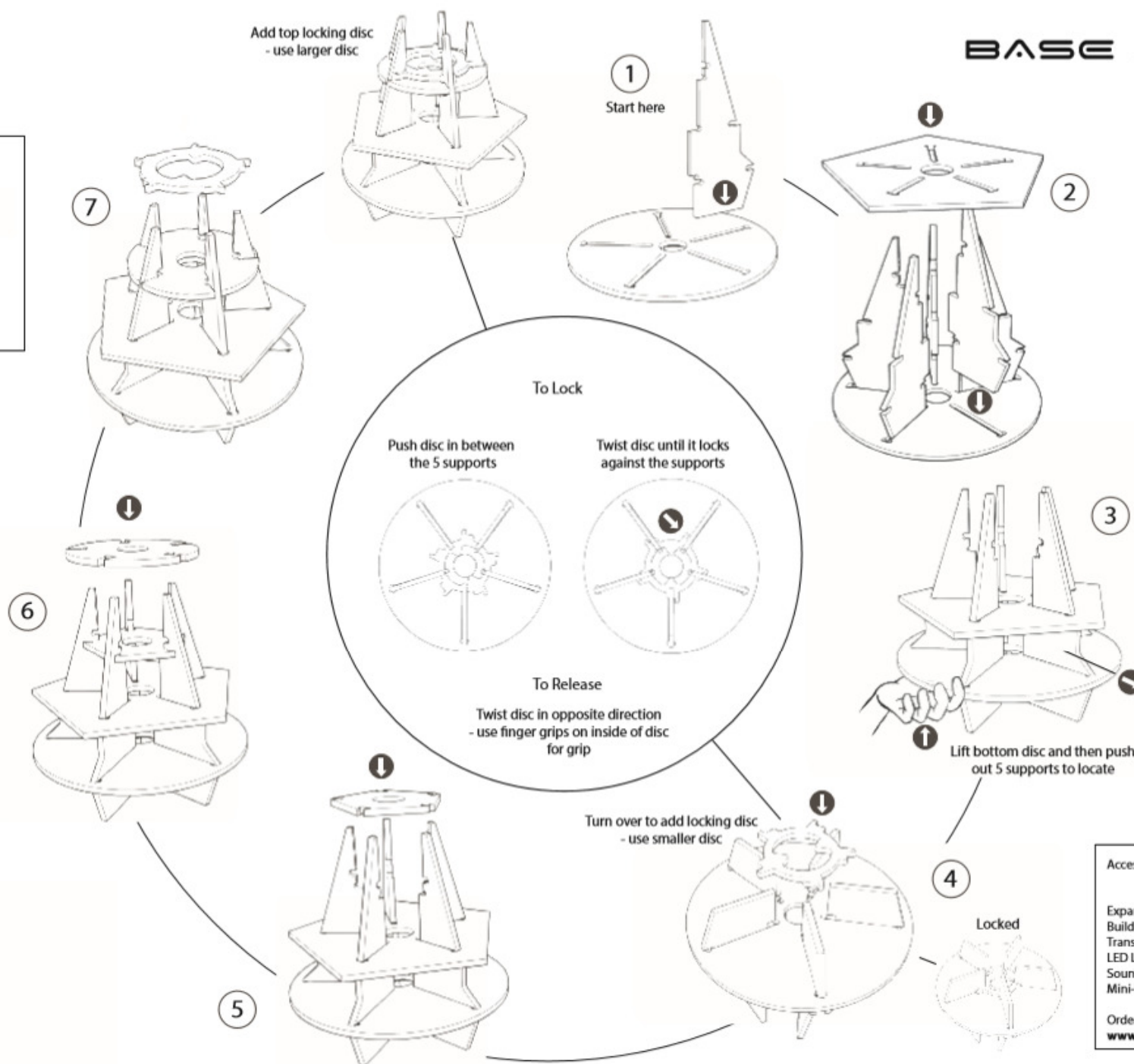
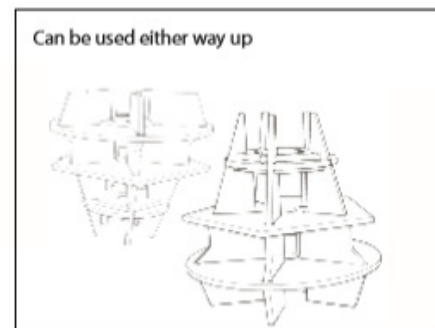
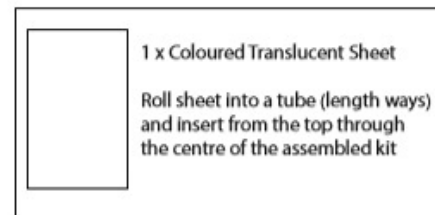
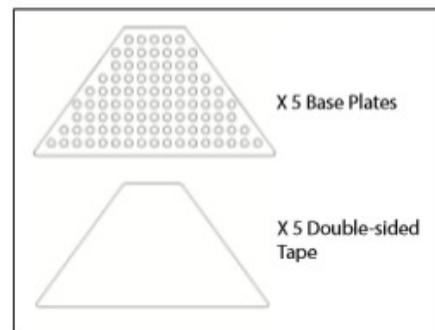
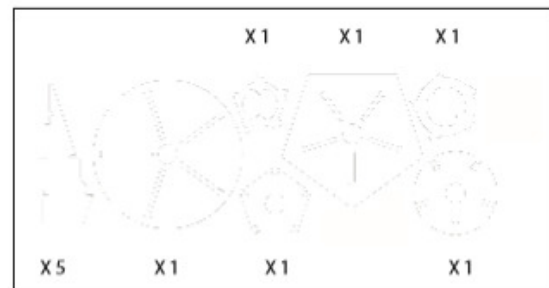

Accessories available for Kit 3

- Expansion Kit
- Building Block Base Plates
- Transporter Platform
- LED Lights
- Sound Effect Module
- Mini-Figure Stands

Order at:
www.TalkingProducts.com

SEE WEBSITE FOR DETAILS OF THE FULL RANGE AND ACCESSORIES

KIT 3 EXPANSION KIT BAE-E3-3001

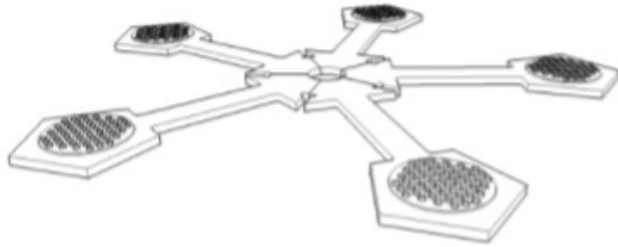

KIT 3 EXPANSION KIT SHOWN ASSEMBLED WITH KIT 3 CAN BE USED EITHER WAY UP

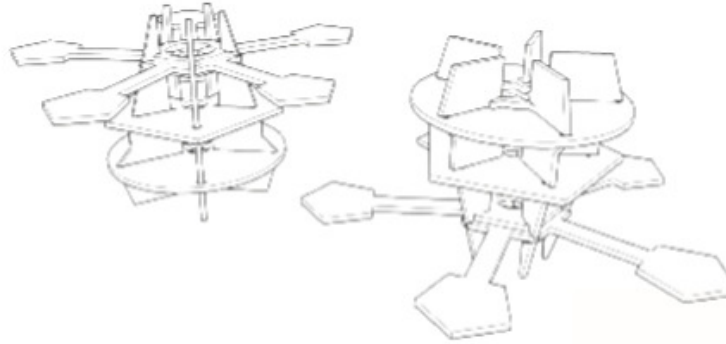

KIT 3 EXPANSION KIT BAE-E3-3001 BASE PLATE ATTACHMENT

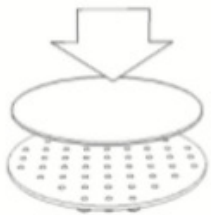

STEP 1
Remove backing from one side of the double-sided tape and attach to the underside of a Base Plate



STEP 2
Check alignment to ensure the tape is centralised on the Base Plate and then push firmly

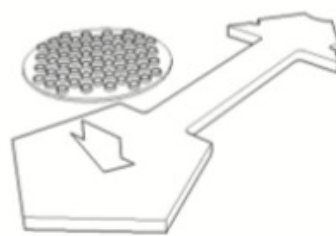

STEP 3
Remove the backing from the underside of the double-sided tape. Position Base Plate holding it just above the surface of the extension platform

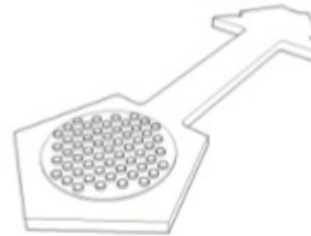

STEP 4
Centralise the Base Plate and ensure the raised dots are aligned with the direction of the long extension platform. Press down firmly to secure

BASE ACE

EXPANSION KIT FOR KIT 3

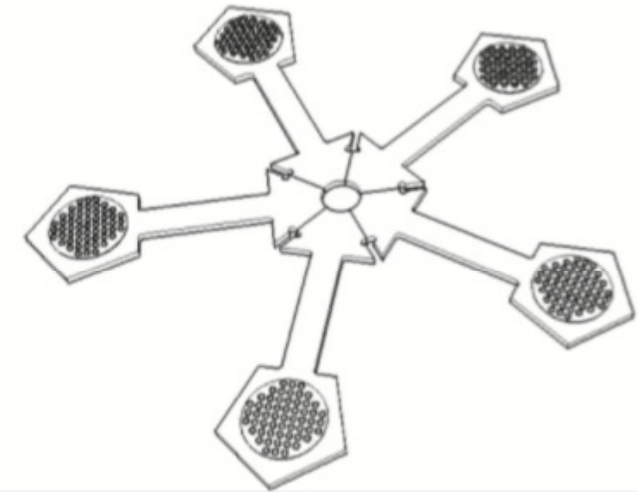

ASSEMBLY INSTRUCTIONS

BAE-E3-3001



copyright
all rights reserved



Base Ace is a registered
Trademark of Talking Products Ltd



www.TalkingProducts.com

ASSEMBLY INSTRUCTIONS

Base Ace Expansion Kit For Kit 3

Product Code: BAE-E3-3001

BASE ACE

Contents

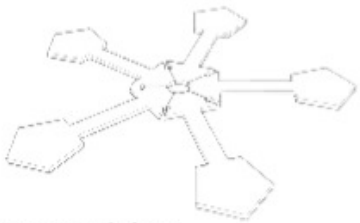

X 5 Expansion Platforms

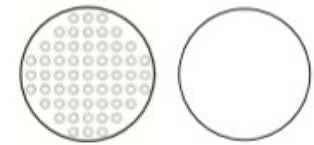

X 5 Base Plates & Self-Adhesive Tape

Expansion Kit assembled with Kit 3

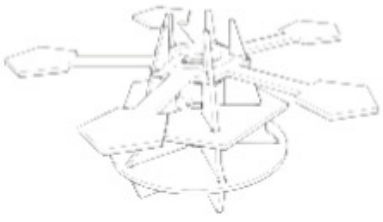

Apply a downward force and rotate disc to lock

Start here ①

⑤

① Unlock

Remove this one disc. Not required for the expansion kit assembly. Retain for future use.

②

To Lock

Push disc between the 5 supports

Twist disc until it locks against the supports

To Release

Twist disc in opposite direction - use finger grips on inside of disc

③

④

①

②

If necessary pull supports to widen gap to allow the Expansion Platform to slide down

Accessories available for Kit 3

- Expansion Kit
- Building Block Base Plates
- Transporter Platform
- LED Lights
- Sound Effect Module
- Mini-Figure Stands

Order at:
www.TalkingProducts.com