

KARAG

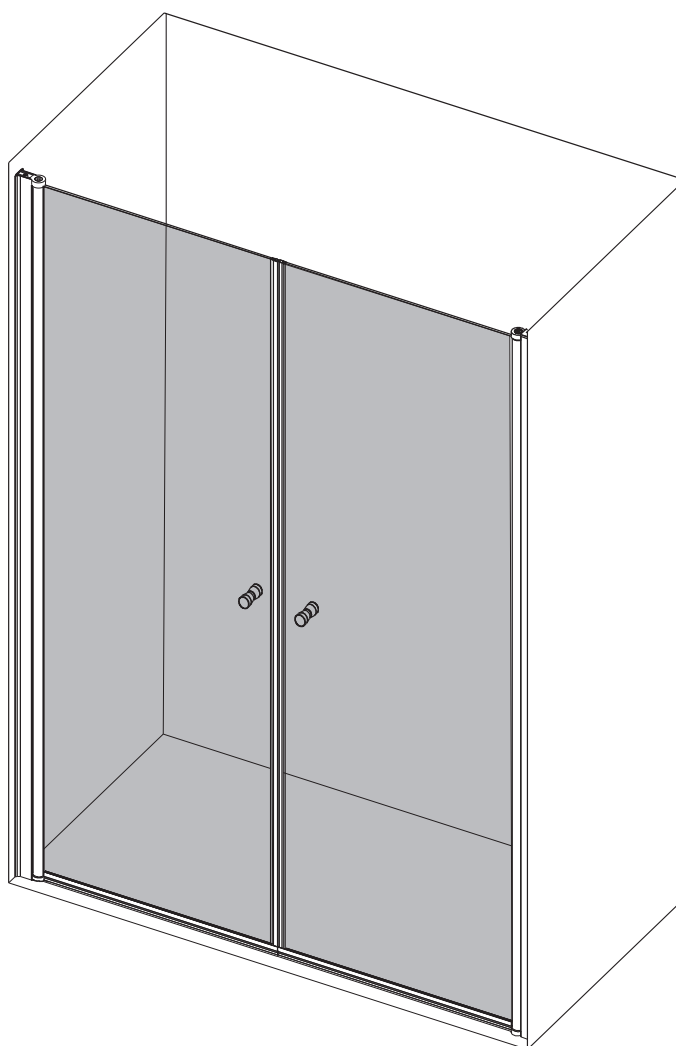











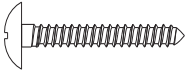
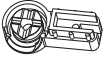

bathroom experience...

INSTALLATION INSTRUCTIONS

INSTALLAZIONE ISTRUZIONI
ΟΔΗΓΙΕΣ ΤΟΠΟΘΕΤΗΣΗΣ

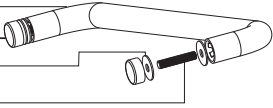

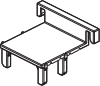
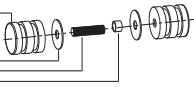
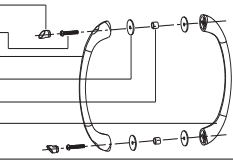
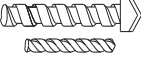
S 28 SALLON CABIN

| No. | Designation | Pieces | No. | Designation | Pieces |
|-----|---|--------|------|--|--------|
| 1 |  | X 2 | 10 1 |  | X 2 |
| 2 |  | X 2 | 10 2 |  | X 2 |
| 3 |  $\varnothing 8$ | X 6+1 | 11 1 |  | X 2 |
| 4 |  ST4X35 | X 6+1 | 11 2 |  | X 2 |
| 5 |  ST4X10 | X 4+1 | 12 |  | X 2 |
| 6 |  ST4X30 | X 4+1 | A1 |  | X 2 |
| 7 |  | X 4+1 | A2 | | X 4 |
| 8 |  | X 2 | A3 | | X 8 |
| 9 |  | X 2 | A4 | | X 4 |
| | | | B1 |  | X 4 |
| | | | B2 | | X 4 |
| | | | B3 | | X 2 |
| | | | B4 | | X 2 |
| | | | 13 |  | X 4 |
| | | | C1 | | X 4 |
| | | | C2 | | X 4 |
| | | | C3 | | X 2 |
| | | | C4 | | X 8 |
| | | | C5 | | X 4 |
| | | | C6 | X 2 | |
| | | | D | No handle | |
| | | | |  $\varnothing 8$  $\varnothing 3.2$ | |

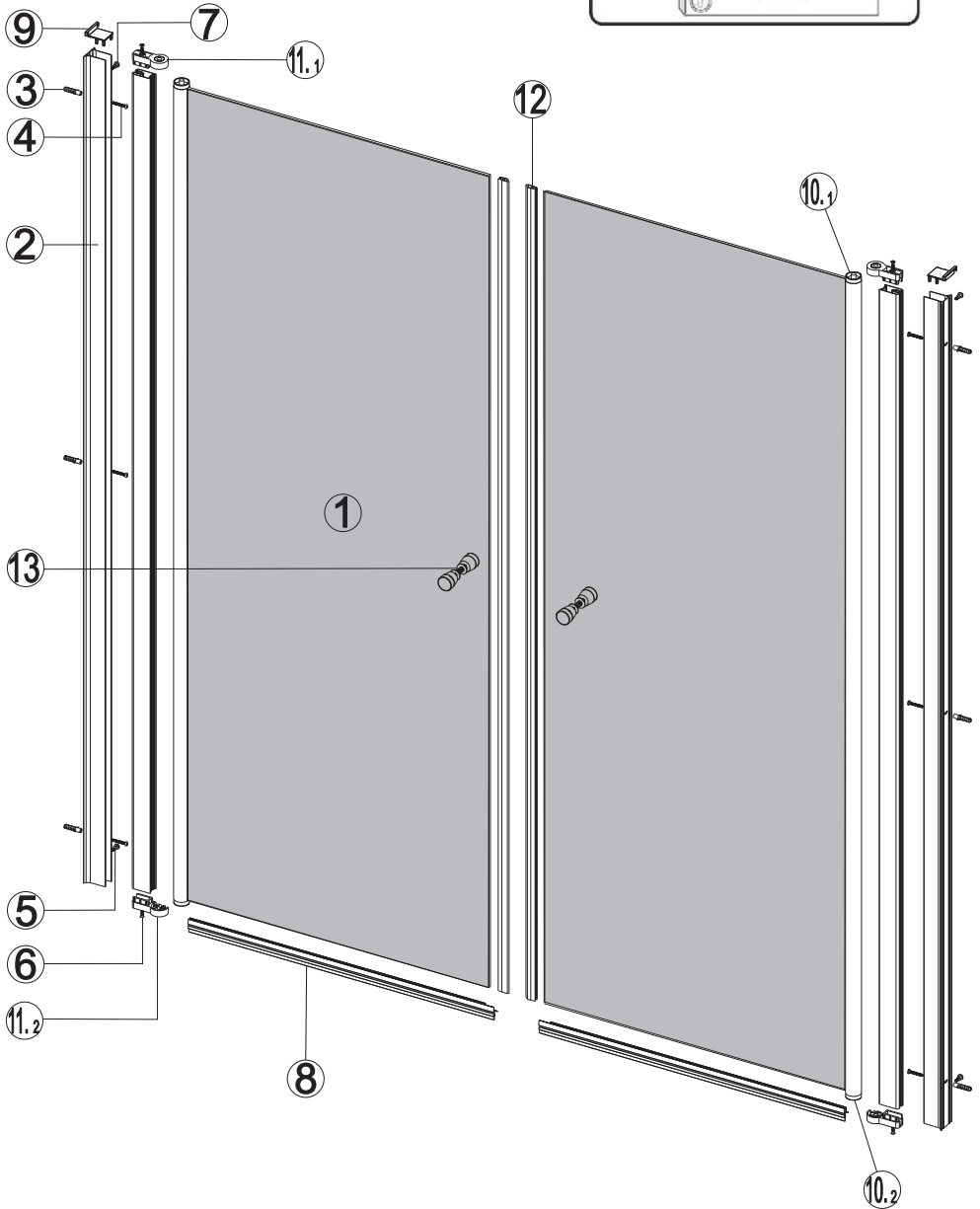
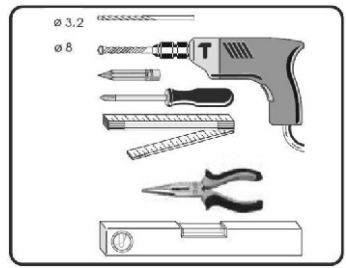
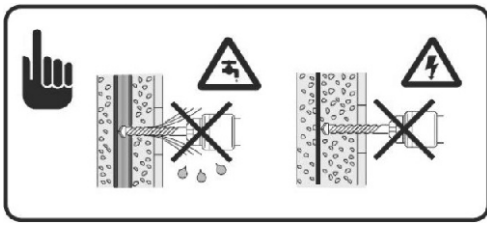

1.

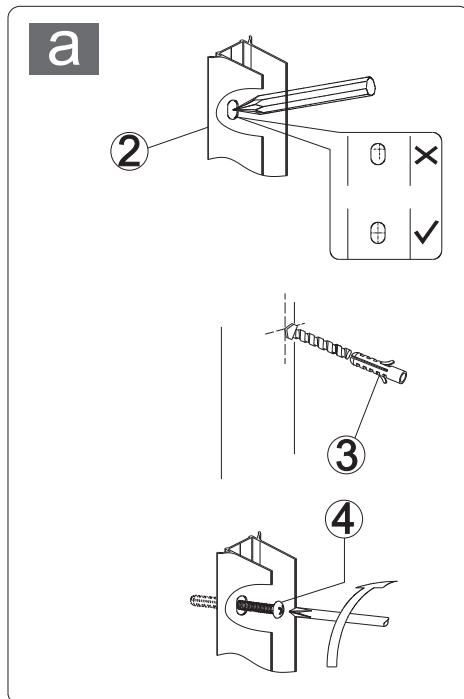
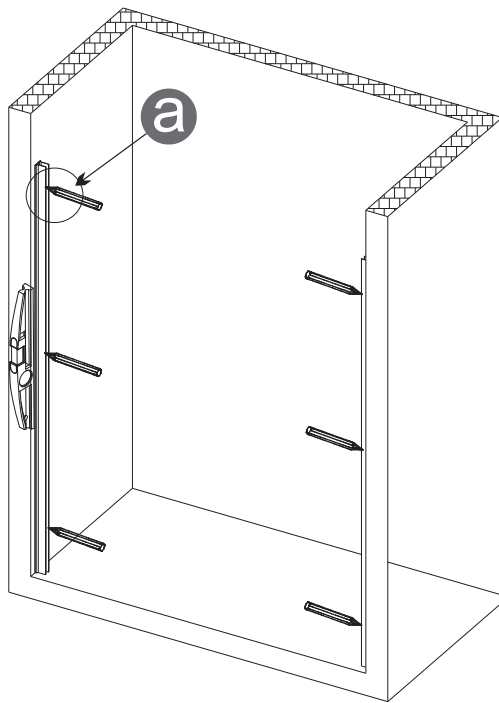

2.

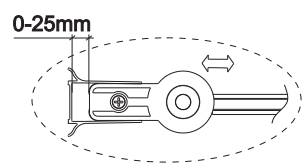
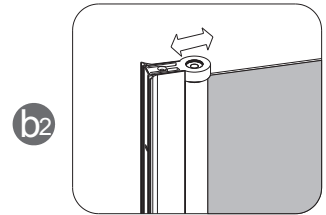
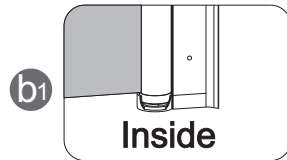
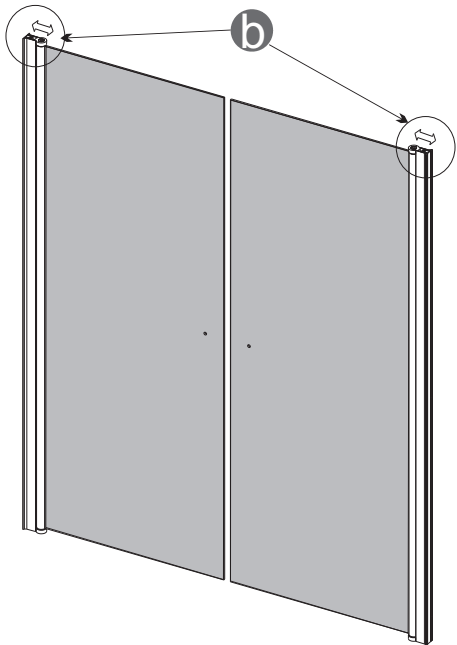
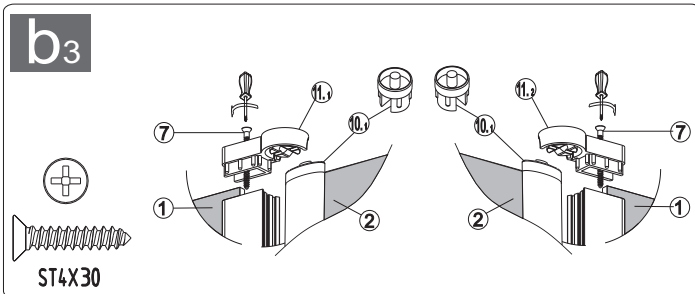
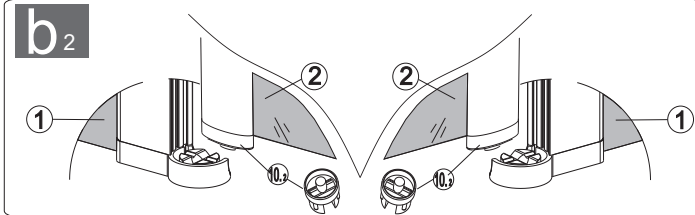
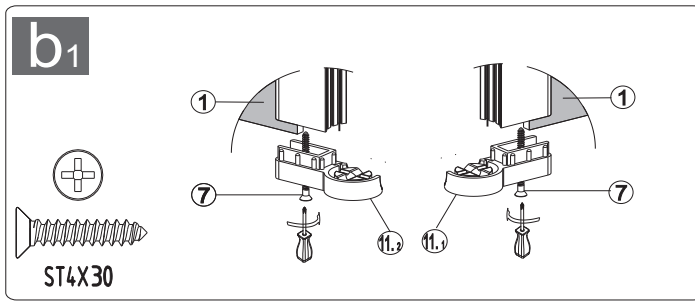

3.

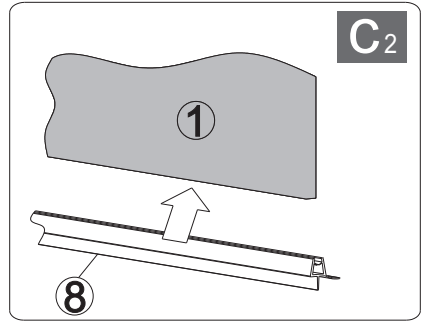
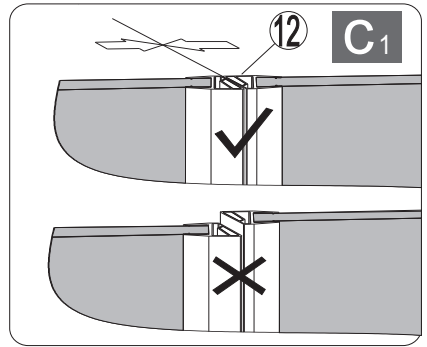
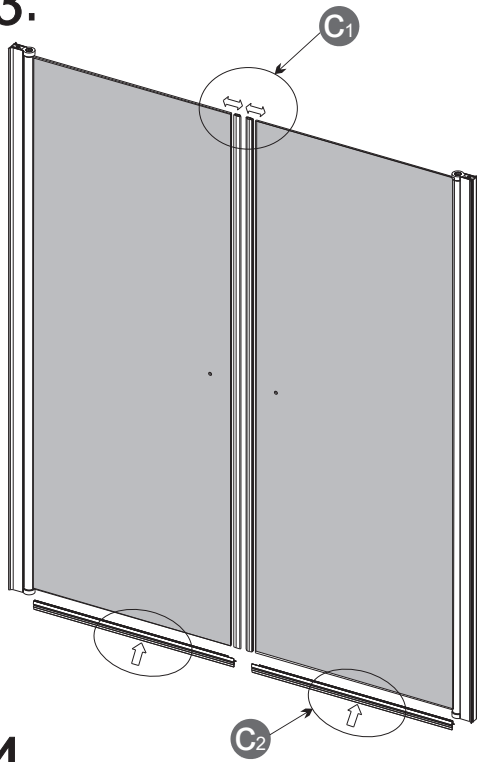

4.

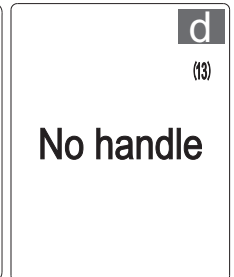
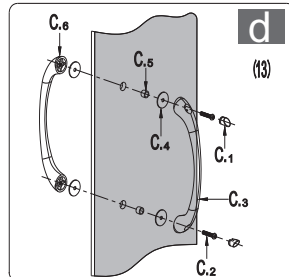
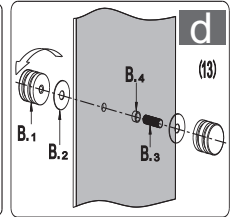
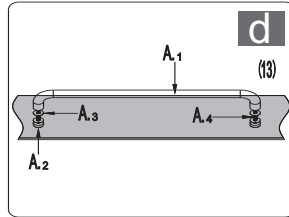
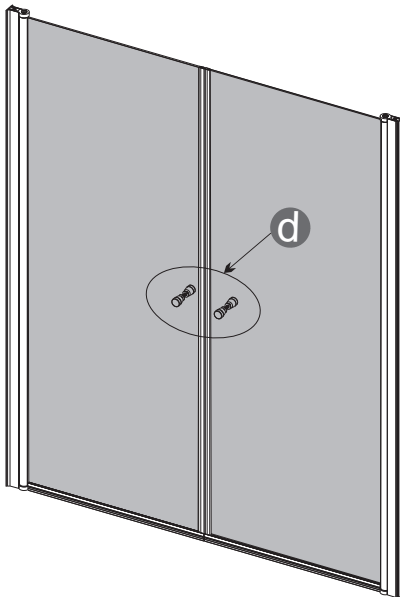

5.

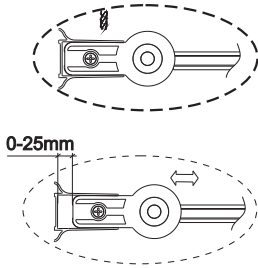
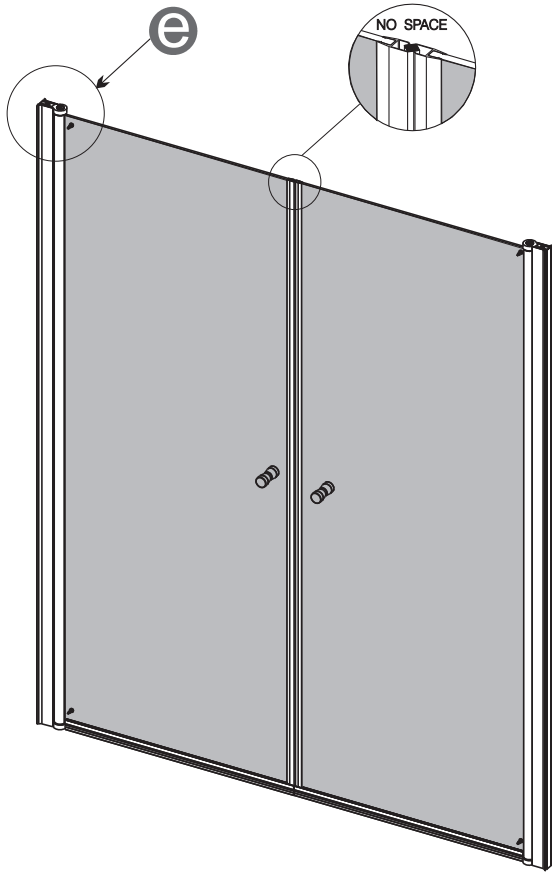

6.

