

# Mag 6 & 8 System Manual



Underground Magnetics

[www.undergroundmagnetics.com](http://www.undergroundmagnetics.com)



## Contents of MAG 8

<b>1: Introduction</b> .....	<b>1</b>
<b>2: Caution</b> .....	<b>2</b>
<b>3: System Highlights</b> .....	<b>3</b>
<b>4: Receiver</b> .....	<b>3</b>
4.1: Specifications.....	3
4.2: Receiver Operation.....	4
4.3: Icons.....	5
4.3.1: Main Page Icons.....	5
4.3.2: Secondary Page Icons.....	7
4.3.3: Calibration and Depth Forecast Page Icons.....	8
4.3.4: Setup Page Icons.....	8
4.4: Calibration.....	9
4.4.1: Depth Calibration.....	9
4.4.2: Roll Calibration.....	10
4.5: Operation.....	11
4.5.1: Depth Prediction.....	11
4.5.2: Transmitter Activation.....	12
4.5.3: Transmitter Settings.....	13
4.5.4: Receiver Settings.....	14
4.5.5: Radio Channel Selection.....	15
4.5.6: Pairing.....	16
4.5.7: Pitch Unit Selection.....	17
4.5.8: Time Setting.....	18
4.5.9: System Unlock.....	19
4.5.10: Visibility Control.....	20
4.5.11: Speed Control.....	21
4.6: Receiver Maintenance.....	22

<b>5: Display</b> .....	23
5.1: Specifications.....	23
5.2: Display Operations.....	23
5.2.1: Down Hole Echo Mode Change.....	24
5.2.2: Radio Channel Selection.....	26
5.2.3: Pairing.....	27
5.2.4: Pitch Unit Selection.....	28
5.2.5: Distance Unit Selection.....	29
5.2.6: Visibility Control.....	30
5.3: Display Maintenance.....	31
<b>6: Transmitter</b> .....	32
6.1: Introduction.....	32
6.2: Specifications.....	33
6.3: Digital Information.....	37
6.4: Transmitter Maintenance.....	37
<b>7: Locating Methods</b> .....	38
7.1: Locating Basics.....	38
7.1.1: Three Point Locating.....	38
7.1.2: Single Point Locating.....	40
7.2: Bore-To.....	41
<b>8: Battery and Charger</b> .....	42
<b>9: Warranty</b> .....	42

# 1: Introduction

---

The MAG 6 & 8 are locating systems designed to assist horizontal directional drill machine operators in locating and tracking underground drill head locations and orientations. The system consists of a **transmitter**, a **receiver**, and a remote **display**.

The **transmitter** sends digital information of the transmitter's pitch, roll, temperature, and battery status through an FM modulated RF signal.

The **receiver** receives this information and uses RF signal to identify the transmitter's status and location.







The receiver transmits the locating information to a remote **display** through a radio telemetry system. A horizontal directional drill machine operator can use the information from the display to guide the drill head to the desired path.

These locating systems also offer four channel license free radio telemetries between the receiver and remote display. The user can easily "pair" any two receivers and displays so that communications between the "pair" will not be interfered by other "pairs".

This manual is intended to provide information and instructions on how to use these locating systems properly. Underground Magnetics Inc. (UM) reserves the right to improve the locating systems and the Operator's Manual at any time without notice.

## 2: Caution

---

-  The operator must understand safety procedures and correct operation methods before operating the HDD and the locating system.
-  HDD machines can cause property damage and personal injury upon striking underground power lines, gas lines, phone lines, television cables, fiber optic cables, or sewage lines. Make sure to confirm and mark all underground utilities before beginning operations.
-  Do not use the locating system near flammable or explosive substances.
-  Wear proper personal protective equipment including steel-toed boots, safety gloves, helmets, reflective vests, and safety goggles.
-  Obey all local safety regulations.
-  This locating system is only a tool to assist the operator to locate the drill head. It is the operator, not the Mag locating system that is responsible for identifying the drill head location. UM is not responsible for any damage or loss caused by using the Mag system. Operators should operate the Mag system according to the manual.
-  If there are any questions, please contact Underground Magnetics.

## 3: System Highlights

- High precision and high anti-interference Faraday shield 3D antenna structure
- Industrial rated, gold-plated electronic modules
- High-performance DSP
- Dual locating system, functioning as two receivers independently tracking to provide better accuracy and reliability
- Up to 110m depth range and up to 120 hours continuous usage

## 4: Receiver

### 4.1: Specifications

#### Mag 8



<b>11 System frequencies</b>	4kHz – 31kHz
<b>Water resistant</b>	IP65
<b>Temperature range</b>	-20° to 60°C
<b>Telemetry</b>	4 radio channels with range up to 0.9km (900m)
<b>Rechargeable lithium battery</b>	12.5V
<b>Battery life</b>	Up to 50 hours
<b>Dimensions</b>	68.5cm * 13cm * 30cm
<b>Weight</b>	3kg
<b>Compatibility</b>	XNeedle-M, Echo 1, Echo 2S, Echo 50, Echo 60, Echo 70, Echo 90, Echo110

## Mag 6

<b>11 System frequencies</b>	4kHz – 31kHz
<b>Water resistant</b>	IP65
<b>Temperature range</b>	-20° to 60°C
<b>Telemetry</b>	4 radio channels with range up to 0.9km (900m)
<b>Rechargeable lithium battery</b>	12.5V
<b>Battery life</b>	Up to 50 hours
<b>Dimensions</b>	68.5cm * 13cm * 30cm
<b>Weight</b>	3kg
<b>Compatibility</b>	XNeedle-M, Echo 1, Echo 2S, Echo 50, Echo 70



### 4.2: Receiver Operation



**Power key:** Press and hold to turn on or off. Tap to turn backlight on or off.



**Up key:** Move to previous cursor selection.



**Down key:** Move to next cursor selection.



**Confirm key:** Tap to confirm cursor selection. Press and hold to enter secondary page. Tap from main page to enter Bore-To mode.



**Setup key:** Tap to enter calibration page/ return to main page. Press and hold to enter setup page



## 4.3: Icons

### 4.3.1: Main Page Icons

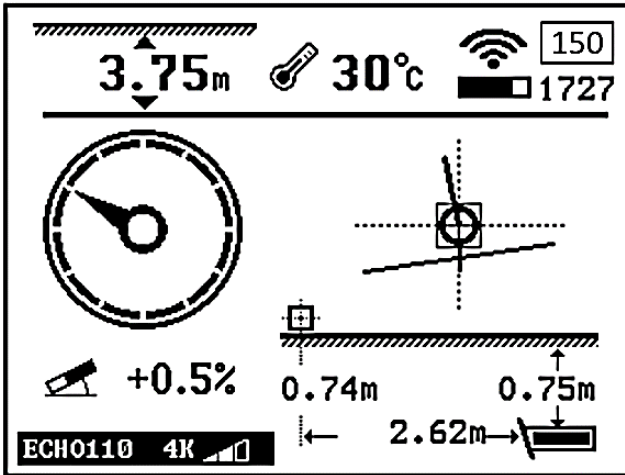

ECHO110 4K

- Transmitter model, frequency, and power

150

- Noise

1727

- Signal strength



- Visual representation of signal to noise

30°C

- Transmitter temperature (Flashing indicates transmitter is over-heating)







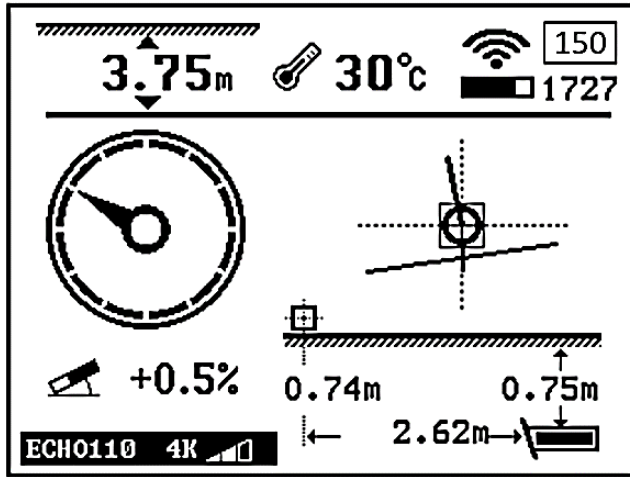

3.75m

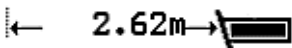
- Direct distance between transmitter and receiver

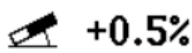
0.75m

- Vertical distance between receiver and transmitter

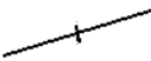



- 
• Estimated horizontal distance between transmitter and receiver
- 
• Estimated transmitter depth
- 
• Transmitter pitch
- 
• Roll indicator
- 
• 24 clock positions
- 
• Single Point: direction of transmitter
- 
• Locate Line
- 
• Receiver

## 4.3.2: Secondary Page Icons

To enter Secondary Page part I, press and hold .

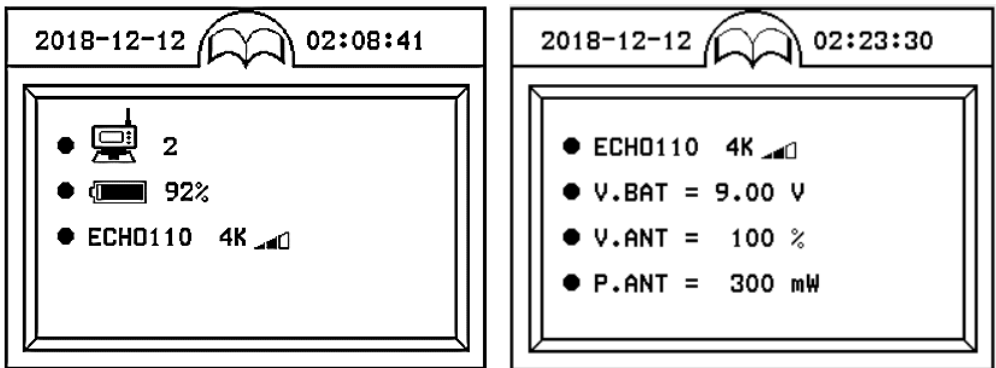
To enter Secondary Page part II, tap  from Secondary Page part I.



**ECHO110 4K**  Transmitter model, frequency, and power

 **92%** Receiver battery status

 **2** Radio channel

**V.BAT = 9.00 V** Battery voltage

**V.ANT = 100 %** Antenna voltage:  
Normal range: 95% - 105%

**P.ANT = 300 mW** Antenna power:  
Normal power mode: 500mW – 800mW  
High power mode: 2000mW – 3000mW

### 4.3.3: Calibration and Depth Forecast Page Icons

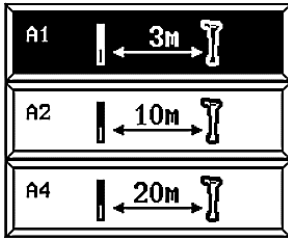

- A1 : 3m calibration
- A2: 10m calibration
- A4 : 20m calibration
- A5: Depth forecast

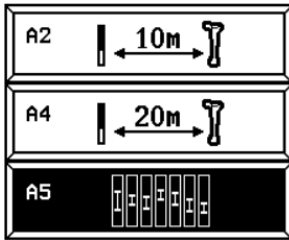

### 4.3.4: Setup Page Icons

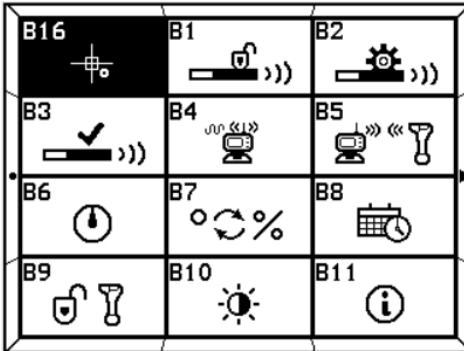

- B1: Transmitter activation
- B2: Transmitter settings
- B3: Receiver settings
- B4: Radio channel selection
- B5: Receiver and display pairing
- B6: Roll calibration
- B7: Pitch unit selection
- B8: Time & date setting
- B9: System lock/unlock
- B10: Visibility control
- B11: System info
- B16: Speed Control

## 4.4: Calibration

### 4.4.1: Depth Calibration (3m, 10m, 20m)

**Warning:** Even if the transmitter's roll, pitch, battery status and temperature are displayed correctly, calibration may not be reliable due to a distorted magnetic field. **Always do the 3m calibration first.**

1. Make sure that the transmitter is working properly. Place it in the housing.
2. Place housing containing the transmitter in a location away from interference.
3. Set transmitter and receiver 3m, 10m, or 20m apart from center of transmitter to inside edge of receiver's base, as shown.

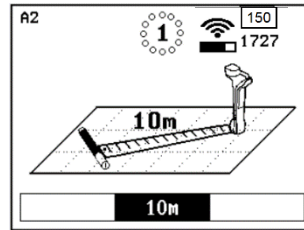
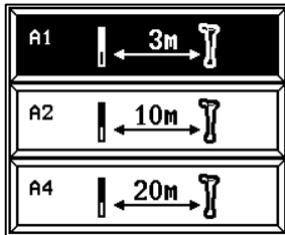
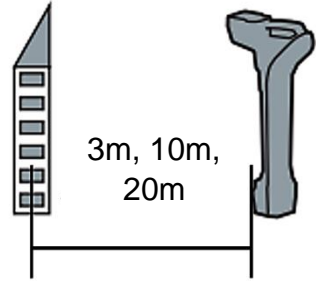

4. Tap to enter Calibration Page.
5. Tap and to highlight desired distance for calibration. Tap three times to start calibration and wait for calibration to complete.

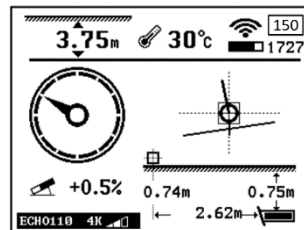
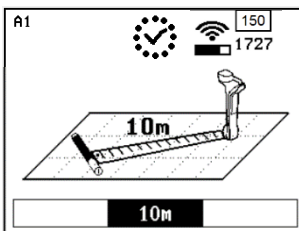



6. Calibration complete.
7. Tap to return to Main Page.

## 4.4.2: Roll Calibration

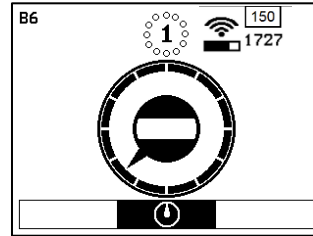
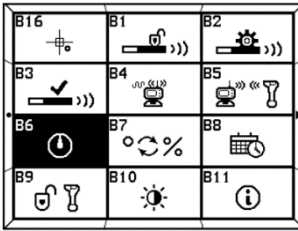
1. Place transmitter housing in a 12 o'clock position.



2. Press and hold  to enter Setup page and tap  to select B6 icon.
3. Tap  three times to enter and start roll calibration and wait for calibration to complete.

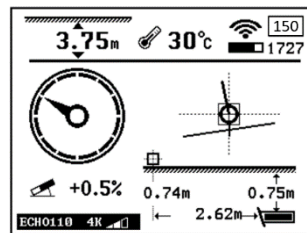
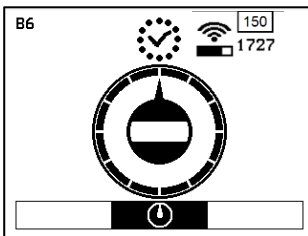

4. Calibration complete.
5. Tap  to return to Main Page.

## 4.5: Operation

### 4.5.1: Depth Forecast

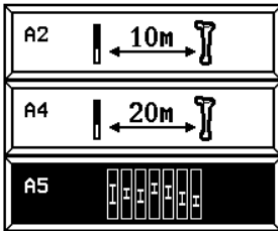

1. Tap to enter calibration page and tap to select A5 icon.

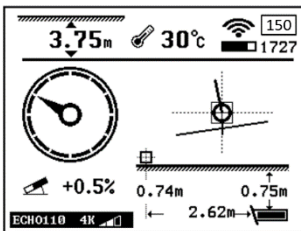

3. Tap to return to Main Page.

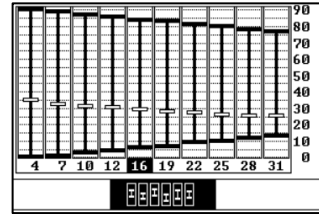

2. Tap to enter Depth Forecast Page.

.... Highest depth  
 .... real-time depth  
 .... lowest depth

Tap to reset forecast.

**Note:** The highest depth forecast value is a conservative value and will be the main value used when determining interference.

## 4.5.2: Transmitter Activation (For dealer or factory use)

(Process must be started within 10 minutes after batteries have been placed in the transmitter.)

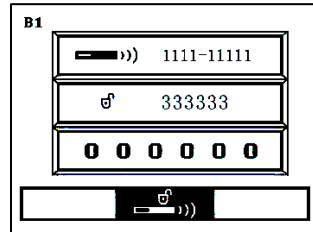
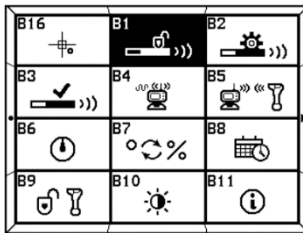

1. Press and hold to enter Setup Page and tap to select B1 icon.
2. Tap to enter Transmitter Activation Page.

1111-1111 is the transmitter identification number and 3333-3333 is the prompt code in the diagram. Send the transmitter identification number and the prompt code to the dealer. The dealer will give you an activation password. Use and to input password, tap to confirm activation.

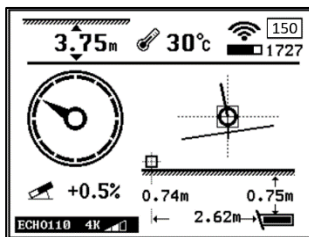

3. Tap to return to Main Page.



### 4.5.3: Transmitter Settings

(Process must be started within 10 minutes after batteries have been placed in the transmitter.)

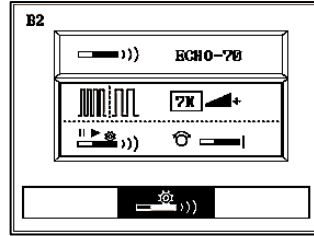
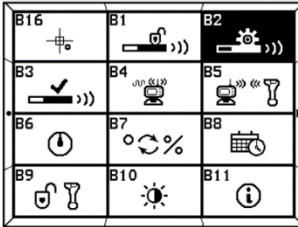

1. Press and hold to enter Setup Page and tap to select B2 icon.
2. Tap to enter Transmitter Settings Page. The receiver and Echo transmitter will automatically pair. Then tap or and to select frequency and power level. Tap to highlight Wake Up Mode and tap to enter. Then tap or to select desired mode.

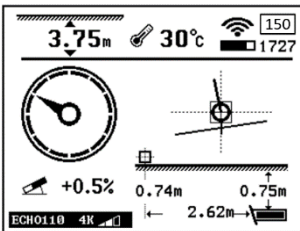

3. Tap to return to Main Page.

- Instant**  
(rotate the transmitter 4 degrees or change the pitch by 1 degree)
- 360 degrees**  
(rotate the transmitter a full 360° several times)
- Always on**

## 4.5.4: Receiver Settings

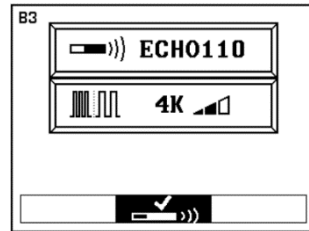
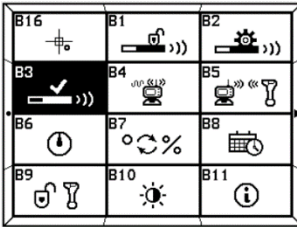



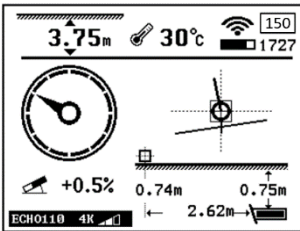



1. Press and hold to enter Setup Page. Tap to select B3 icon.
2. Tap to enter Receiver Settings Page. Tap or and to select transmitter model, frequency, and power.

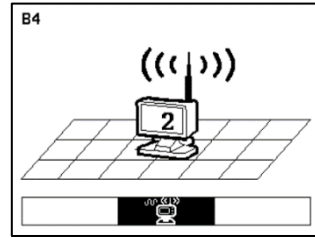
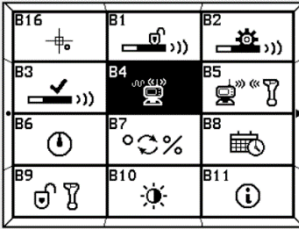

3. Tap to return to Main Page.

## 4.5.5: Radio Channel Selection



1. Press and hold  to enter Setup Page. Tap  to select B4 icon.
2. Tap  to enter Radio Channel Page. Use  or  to select radio channel.

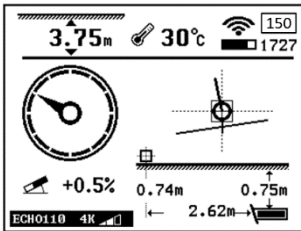

3. Tap  to return to Main Page.

## 4.5.6: Pairing

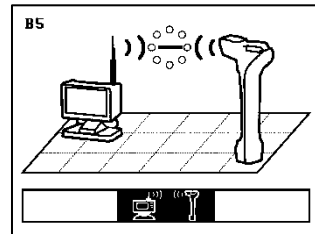
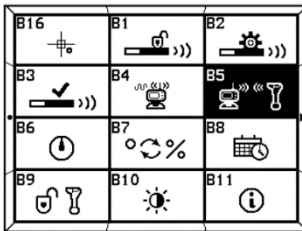



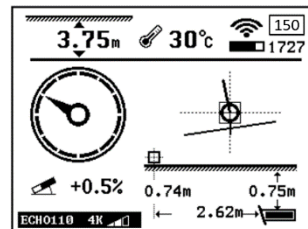
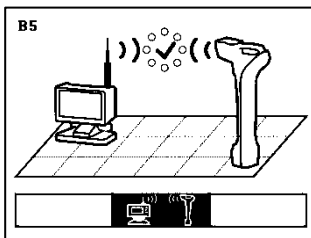

1. Press and hold to enter Setup Page. Tap to select B5 icon.
2. Tap to enter Pairing Page. Tap to start pairing. (It is required that these last two steps are performed on the display at the same time.)

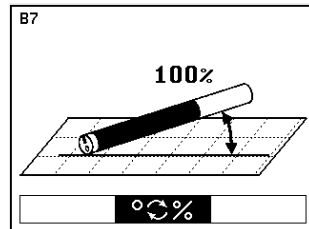
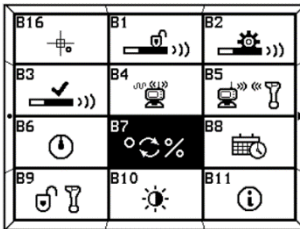

3. Pairing complete.
4. Tap to return to Main Page.

## 4.5.7: Pitch Unit Selection



1. Press and hold  to enter Setup Page and tap  to select B7 icon. Tap  to enter Pitch Unit Selection Page.
2. Tap  to switch pitch mode.

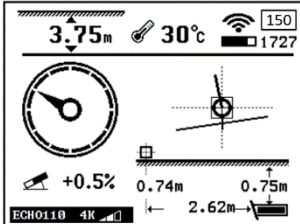

3. Tap  to return to Main Page.

## 4.5.8: Time Setting

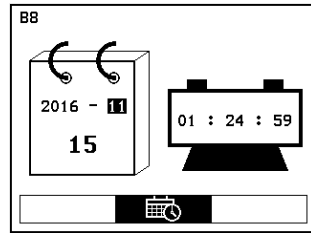
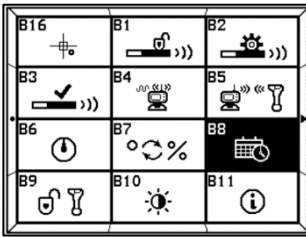

1. Press and hold to enter Setup Page. Tap to select B8 icon.
2. Tap to enter Time Settings Page. Tap to select year, month, day, hour, or minute. Tap or to set time.

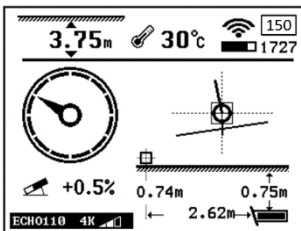

3. Tap to return to Main Page.

## 4.5.9: System Unlock (To obtain password, please contact your dealer)

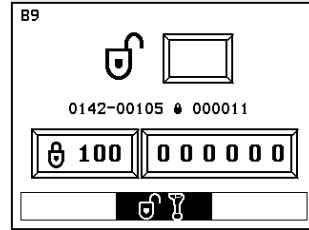
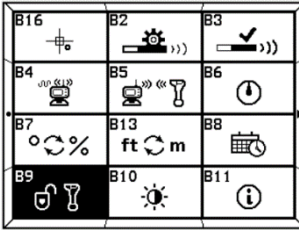

1. Press and hold to enter Setup Page and tap to select B9 icon. Tap to enter System Unlock Page.
2. Tap and or to change number of days (default is 100). Tap again to select password. Tap or and to input password.

Tap a final time and number of days unlocked will appear in the top box.

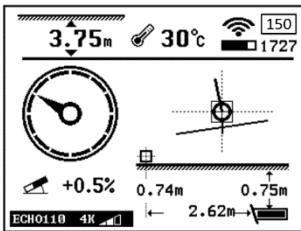

3. Tap to return to Main Page.

## 4.5.10: Visibility Control

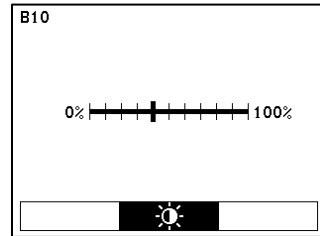
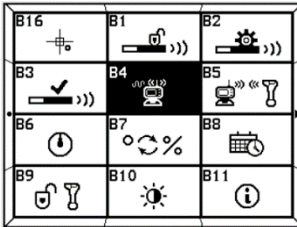

1. Press and hold to enter Setup Page and tap to select the B10 icon. Tap to enter Visibility Control.
2. Tap and to adjust.

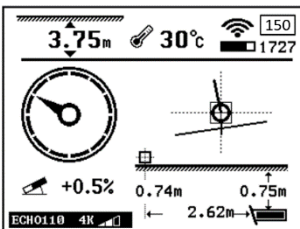





3. Tap to return to Main Page.

**Note:** By holding both and at the same time while turning the receiver on, the visibility control will reset to normal visibility.

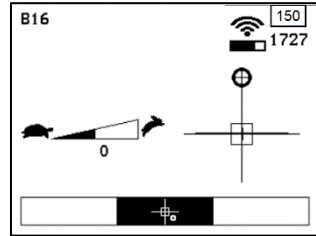
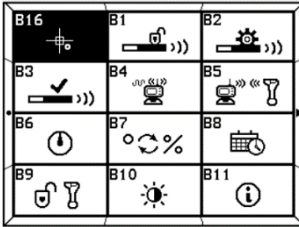

## 4.5.11: Speed Control (Adjusting speed control of the ball)



1. Press and hold  to enter Setup Page and tap  to enter the Speed Control Page.
2. Tap  and  to adjust speed.

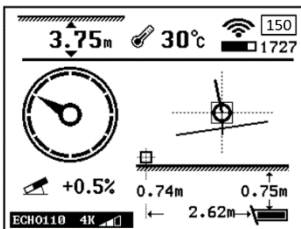

3. Tap  to return to Main Page.

### Note:

0 to 100 is the index for speeding up (suitable for shallow depths)

-100 to 0 is the index for slowing down (suitable for deeper depths)

## 4.6: Receiver Maintenance

- The receiver uses rechargeable lithium batteries. The receiver will automatically shut off if no key is pressed for over a period of 20 minutes or if there is no information received from the transmitter. It is strongly recommended that the batteries are taken out of the receiver if it is not being used for a long period of time to avoid potential corrosion.
- The receiver is an electronic measurement device. Severe shock and impact can damage the housing and the electronics inside the housing.
- Keep the receiver away from excessive heat to avoid damages to the plastic housing and the electronics inside the housing.
- Do not soak the receiver in excessive amounts of water.



# 5 Display





## 5.1: Display Specifications

### Mag D6



<b>Radio frequency</b>	867MHz
<b>Water resistant</b>	IP65
<b>Temperature range</b>	-20° to 60°C
<b>Telemetry</b>	4 radio channels with range up to 0.9km (900m)
<b>Power</b>	Rechargeable lithium batteries
<b>Battery life</b>	Up to 50 hours
<b>Screen</b>	Industrial rated LCD graphic screen
<b>Dimensions</b>	19cm x 13cm x 19cm
<b>Weight</b>	1.5kg

## 5.2: Display Operations

-  Power key: Press and hold to turn on or off. Tap to select level of backlight.
-  Up key: Move to previous cursor selection.
-  Down key: Move to next cursor selection.
-  Confirm key: Tap to confirm cursor selection. Press and hold to enter secondary page.
-  Setup key: Tap to return to main page. Press and hold to enter setup page.

## 5.2.1: Down Hole Echo Mode Change (Echo 2S and Echo 3)

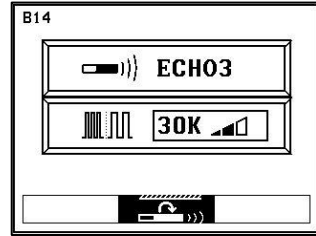
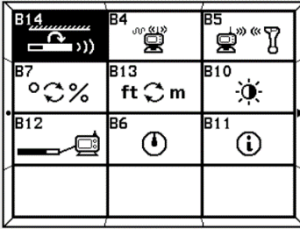

1. Press and hold to enter Setup Page. Tap to enter Down Hole Echo Mode Change Page.
2. Use or to select desired frequency and power levels. Tap to begin mode change process.

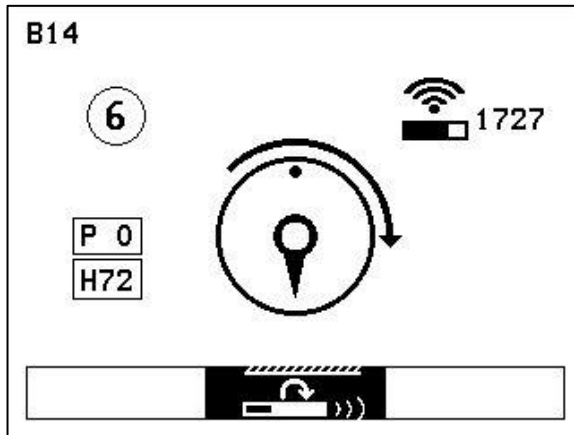

Roll indicator



Steps remaining



Target dot



Instructions



Hold: hold this roll position until it counts down to 0



Proceed: time left to proceed in process by rotating to new roll position in sequence

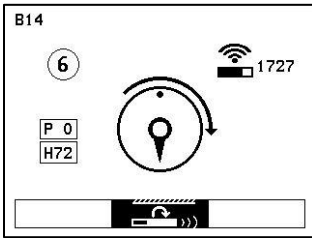

Rotate drill head until roll indicator points toward target dot. Instructions will change from the clockwise arrow to “STOP”.

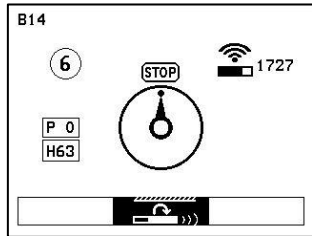

Hold this position until “H” counts down to 0.

Rotate drill head to next position in sequence before “P” counts down to 0 or the sequence will be canceled.

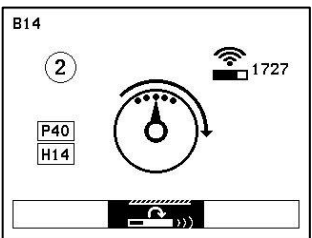



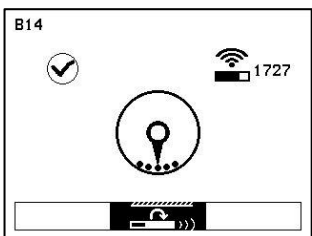
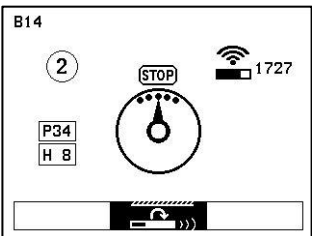

If the next step has the target dots in the same place as the previous step, rotate the drill head one entire rotation until the roll indicator lines up with the target dots again.

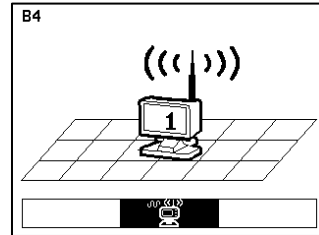
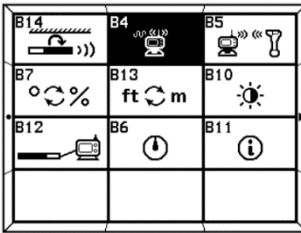

Once all six steps of the sequence are complete, change the Transmitter Settings on the receiver to match the new frequency and power levels.

## 5.2.2: Radio Channel Selection





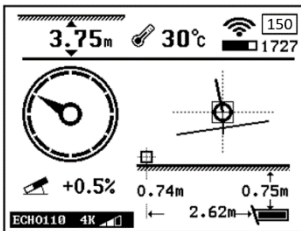

1. Press and hold  to enter Setup Page and tap  to select B4 icon. Tap  to enter Radio Channel Page.
2. Use  to select radio channel.



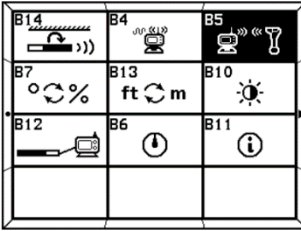

3. Tap  to return to Main Page.

## 5.2.3: Pairing

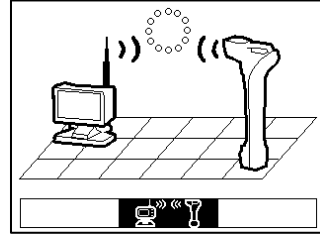

1. Press and hold  to enter Setup Page and tap  to select B5 icon. Tap  to enter Radio Registration Page.



2. Tap  to start pairing. (It is required that the following procedure is performed on the receiver at the same time)

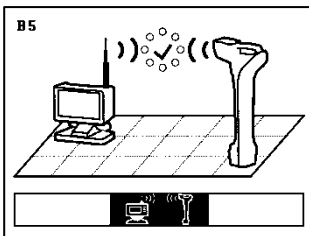



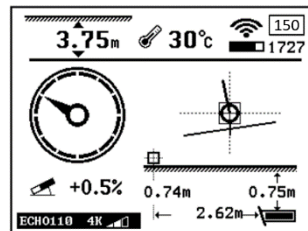

3. Pairing complete.



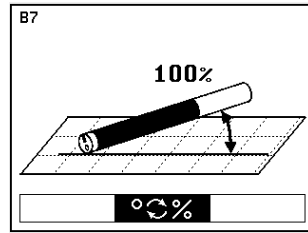
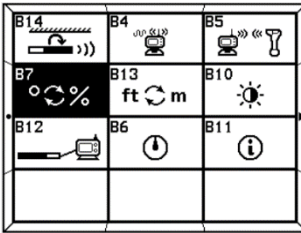

4. Tap  to return to Main Page.

## 5.2.4: Pitch Unit Selection

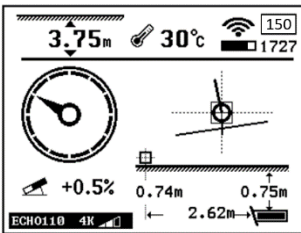

1. Press and hold  to enter Setup Page and tap  to select B7 icon. Tap  to enter Pitch Unit Selection Page.
2. Tap  to switch pitch mode.







3. Tap  to return to Main Page.

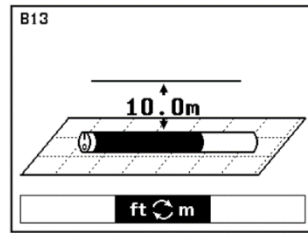
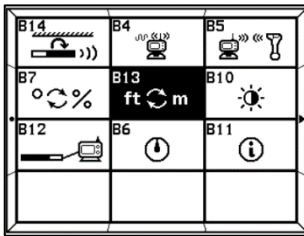

## 5.2.5: Distance Unit Selection



1. Press and hold  to enter Setup Page. Tap  to select B13 icon.
2. Tap  to enter Distance Unit Selection Page. Tap  or  to select unit and format.

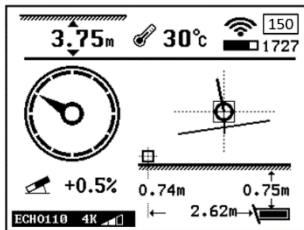

3. Tap  to return to Main Page.

## 5.2.6: Visibility Control

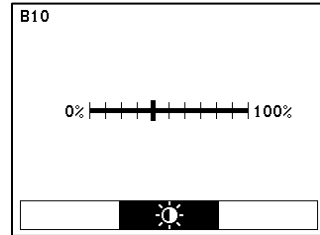
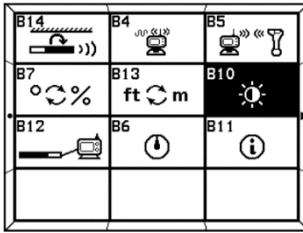

1. Press and hold to enter Setup Page and tap to select the B10 icon. Tap to enter Visibility Control Page.
2. Tap and to adjust.

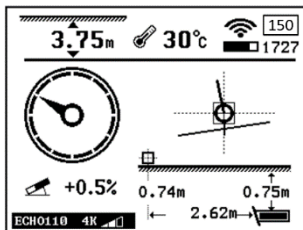

3. Tap to return to Main Page.

**Note:** By holding both and at the same time while turning the display on, the visibility control will reset to normal visibility.

## 5.3: Display Maintenance

- The display uses rechargeable lithium batteries. The display will automatically shut off if no key is pressed for over a period of 20 minutes or if there is no information received from the receiver. It is strongly recommended that the batteries are taken out of the display if it is not being used for a long period of time to avoid potential corrosion.
- The display is an electronic measurement device. Severe shock and impact can damage the housing and the electronics inside the housing.
- Keep the display away from excessive heat to avoid damages to the plastic housing and electronics inside the housing.
- Do not submerge the display in excessive amounts of water.



# 6: Transmitter

## 6.1: Introduction

The transmitter provides drill head temperature, clock position, pitch, battery status and locating signal. The transmitter transmits signals at 4kHz, 7kHz, 10kHz, 12kHz, 16kHz, 19 kHz, 22kHz, 25kHz, 28kHz, 30kHz, or 31kHz. The transmitter will enter a “sleep” mode after 15 minutes without rotation. It takes 10 seconds to “wake up” once the transmitter is rotated.

**Note:** If drilling in adverse soil conditions (i.e. rock), normal C cell batteries will experience battery chatter. This can greatly reduce battery life. To prevent this, use your provided double C lithium cell battery instead.



## 6.2: Specifications

### Echo 1



<b>Dimensions</b>	3.2cm x 38cm	
<b>Frequency</b>	4kHz/19kHz/30kHz	
<b>Depth Range</b>	25m/40m/40m	
<b>Power</b>	2 C cells, Echo Cell Kit, or Lithium Battery	
	<b>C cell</b>	3V, 12 hours of continuous usage
	<b>Echo Cell Kit</b>	3V, 20 hours of continuous usage
	<b>Lithium*</b>	3V, 48 hours of continuous usage
<b>Temperature</b>	Under 121°C	

### Echo 2S



<b>Dimensions</b>	3.2cm x 38cm	
<b>Frequency</b>	4kHz/19kHz/30kHz	
<b>Depth Range</b>	25m/40m/40m	
<b>Power</b>	Echo Cell Kit or Lithium Battery	
	<b>Echo Cell Kit</b>	3V, 20 hours of continuous usage
	<b>Lithium*</b>	3V, 48 hours of continuous usage
<b>Temperature</b>	Under 121°C	
<b>High Power Modes</b>	<ul style="list-style-type: none"> <li>• 19kHz and 30kHz depth range of 50m</li> <li>• Operating time is 5 hours for Echo Cell Kit and 12 hours for lithium battery</li> </ul>	

## Echo 50



<b>Dimensions</b>	3.2cm * 38cm	
<b>Frequency</b>	10 frequencies: 4kHz – 31kHz	
<b>Depth Range</b>	Normal power:	40m
	High power:	50m
<b>Power</b>	18650 rechargeable lithium battery 261020 lithium battery	
	<b>18650 (3.7V)</b>	Normal power: 20 hours High power: 5 hours
	<b>261020 (3.7V)</b>	Normal power: 60 hours High power: 15 hours
<b>Temperature</b>	Under 121°C	
<b>Battery Voltage</b>	2.8V – 4.2V	

## Echo 60



<b>Dimensions</b>	3.2cm * 48cm	
<b>Frequency</b>	10 frequencies: 4kHz – 31kHz	
<b>Depth Range</b>	Normal power:	40m
	High power:	60m
<b>Power</b>	(2) 18650 rechargeable lithium batteries (2) 261020 lithium batteries	
	<b>18650 (3.7V)</b>	Normal power: 50 hours High power: 12 hours
	<b>261020 (3.7V)</b>	Normal power: 160 hours High power: 40 hours
<b>Temperature</b>	Under 121°C	
<b>Battery Voltage</b>	5.6V – 8.4V	

## Echo 70



<b>Dimensions</b>	3.6cm * 39.3cm	
<b>Frequency</b>	10 frequencies: 4kHz – 31kHz	
<b>Depth Range</b>	Normal power: 50m	High power: 70m
<b>Power</b>	(3) 18650 rechargeable lithium batteries	
	<b>18650 (3.7V)</b>	Normal power: 60 hours High power: 15 hours
<b>Temperature</b>	Under 121°C	
<b>Battery Voltage</b>	8.4V – 12.6V	

## Echo 90



<b>Dimensions</b>	3.6cm * 45.5cm	
<b>Frequency</b>	10 frequencies: 4kHz – 31kHz	
<b>Depth Range</b>	Normal power: 70m	High power: 90m
<b>Power</b>	(2) 18650B2 rechargeable lithium batteries	
	<b>18650B2 (3.7V)</b>	Normal power: 80 hours High power: 20 hours
<b>Temperature</b>	Under 121°C	
<b>Battery Voltage</b>	5.6V – 8.4V	

## Echo 110

<b>Dimensions</b>	3.6cm * 60.5cm	
<b>Frequency</b>	10 frequencies: 4kHz – 31kHz	
<b>Depth Range</b>	Normal power:	90m
	High power:	110m
<b>Power</b>	(3) 18650B2 rechargeable lithium batteries	
	<b>18650B2 (3.7V)</b>	Normal power: 120 hours
		High power: 30 hours
<b>Temperature</b>	Under 121°C	
<b>Battery Voltage</b>	8.4V – 12.6V	



## XNEEDLE-M

<b>Dimensions</b>	2cm * 16cm	
<b>Frequency</b>	30kHz (19kHz)	
<b>Depth Range</b>	25m	
<b>Power</b>	16340 rechargeable lithium battery	
	<b>Battery Life</b>	Up to 12 hours
	<b>Lithium*</b>	6V, 160 hours of continuous usage
<b>Temperature</b>	Under 121°C	





## 6.3: Digital Information

- Pitch: From -100% to +100% with 0.1% resolution within the range of -45% to +45% and 1.0% resolution outside of that range.
- Roll: 24 transmitter roll positions
- Battery: Install batteries positive side down and install battery cap with provided battery cap tool.
  - C cell: Battery full, 2/3 full, 1/3 full and flash warning
  - Lithium: Will show battery full then flash warning
- Temperature: When the transmitter is overheating, temperature indication on the receiver's screen flashes. If temperature reaches over 121°C, transmitter may be permanently damaged. If this happens, the dot temperature indicator on the front of transmitter will turn black. (Echo 70, Echo 90, and Echo 110 do not have a temperature indicator)

## 6.4: Transmitter Maintenance

- Do not place the transmitter near excessive temperature (over 121°C).
- Do not apply excessive pressure, shock or vibration to the transmitter.
- Take the battery out of the transmitter after use.
- Clean the spring and cap on the battery compartment when necessary.
- Regularly check the sealing ring on the battery cover. Replace if necessary.

# 7: Locating Methods

## 7.1: Locating Basics

There are two main methods of locating a transmitter.

- Three Point Locating
- Single Point Locating

### 7.1.1: Three Point Locating

Three Point Locating is the industry standard method for locating. It locates the transmitter by pinpointing three specific locations along the transmitter's magnetic field. The front locate point (FLP) ahead of the transmitter, the rear locate point (RLP) behind the transmitter and the locate line (LL) above the transmitter.

For the most accurate location and depth of the transmitter, both the FLP and the RLP should be located before locating the LL. The front and rear locate points, when lined up, indicate the exact direction of the transmitter. If the transmitter is level, the locate line will be located directly in-between the two points.

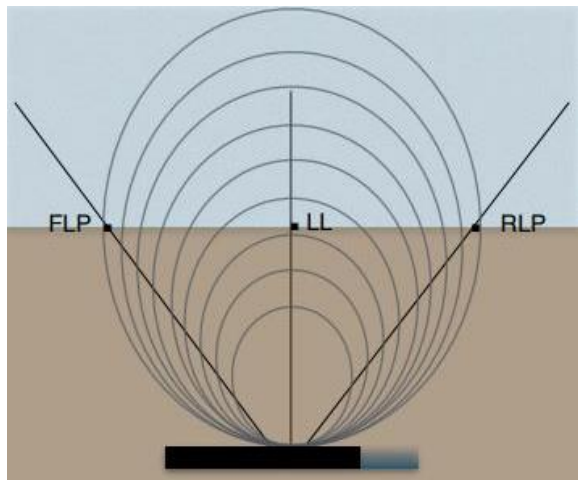

Side view

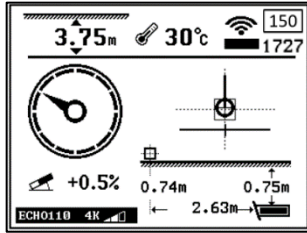
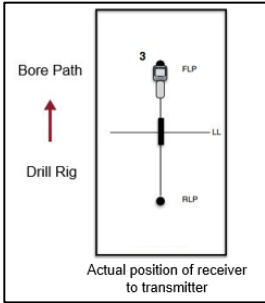

The FLP is a point in front of the transmitter. Locate it by putting the ball in the box.

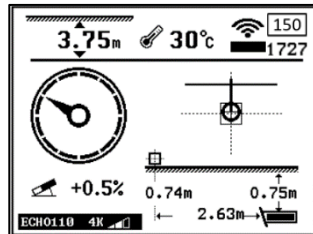
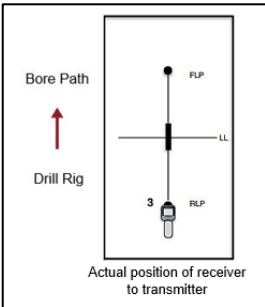

Next, find the RLP. The RLP is a point behind the transmitter. Locate it by putting the ball in the box.

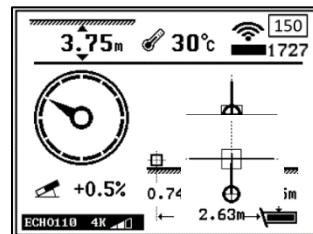
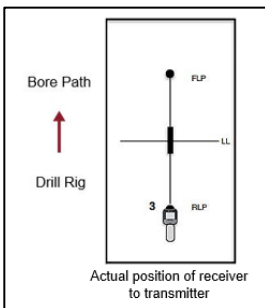

Then, imagine a line that runs through the FLP and RLP. Walk along that line until the LL indicator on the receiver screen enters the box. You are now above the LL.

## 7.1.2: Single Point Locating

Single Point Locating is the newest and most efficient locating method, which is available with the Mag 6 and Mag 8.

Simply locate the front locate point (FLP).

When the ball falls into the box, you are above the FLP. Then continue drilling and locating the FLP to steer.

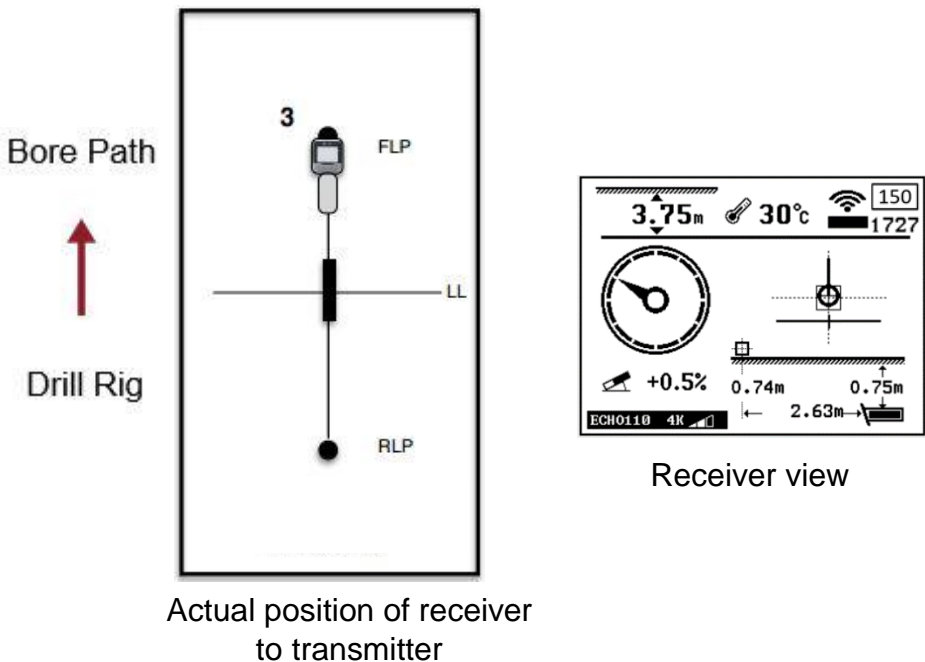

## 7.2: Bore-To

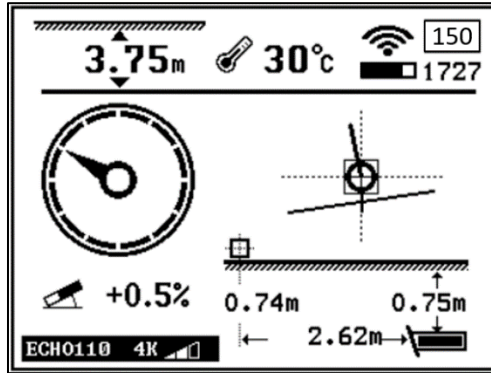

- ← 2.62m → Estimated horizontal distance between transmitter and receiver
- 0.75m Vertical distance between receiver and transmitter
- 0.74m Projected transmitter depth
- 3.75m Direct distance between transmitter and receiver



Hold

To switch between Bore-To and Walkover mode, tap  from the main page or point the bottom of the receiver upward and hold for 2 seconds as shown.

Receiver should always face away from the drill rig

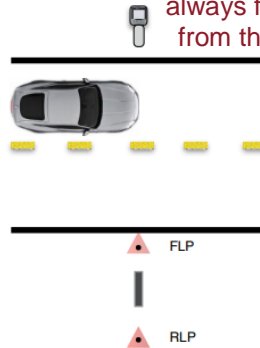

To use Bore-To, place the receiver ahead of the transmitter along the drill path.

Using pitch, depth, and left/right information, put the ball in the box.

### Projected Depth

Projected depth tells you what depth the head is estimated to be at when it reaches the receiver if the operator maintains the indicated pitch.

## 8: Battery and Charger

---

- Mag receivers use lithium rechargeable batteries.
- This lithium rechargeable battery comes with a special charger. Any use of other lithium rechargeable battery or charger for the receiver may cause fire, explosion, leaking or other damages.
- Store the battery at room temperatures (15-25°C). Extreme high or low temperatures will shorten the battery life.
  - Do not submerge the battery in water or any other liquids.
  - Do not throw the battery into fire.
  - Do not disassemble the battery.
  - Avoid any kind of damage to the battery.
  - Please dispose of lithium properly.
- When charging the battery, the red light will shine. When charging is complete, a green light will shine.

## 9: Warranty

---

Underground Magnetics offers standard warranty on parts and labor of the Mag 6 and 8 series locating system under normal usage. The warranty period is one year for the receiver and display and six months for the transmitter. Warranty time is from the date of transaction for receiver and display, and from the date of unlock for the transmitter.





**Underground Magnetics**

[www.undergroundmagnetics.com](http://www.undergroundmagnetics.com)