

Mag 3/6 Systems

Manual



Underground Magnetics

www.umaghdd.com

Contents of Mag 3S & 6S

1: Introduction	1
2: Caution	2
3: FCC Compliance Statement	3
4: Tips for Reading this Manual	4
5: Preface	5
6: System Highlights	7
7: Receiver	9
7.1: Specifications.....	9
7.2: Receiver Operation.....	9
7.3: Icons.....	10
7.3.1: Main Page Icons.....	10
7.3.2: Secondary Page Icons.....	12
7.3.3: Calibration and Depth Forecast Page Icons.....	13
7.3.4: Setup Page Icons.....	13
7.4: Calibration.....	14
7.4.1: Depth Calibration.....	14
7.4.2: Roll Calibration.....	15
7.5: Operation.....	16
7.5.1: Depth Prediction.....	16
7.5.2: Transmitter Activation.....	17
7.5.3: Transmitter Settings.....	18
7.5.4: Receiver Settings.....	19
7.5.5: Radio Channel Selection.....	20
7.5.6: Pairing.....	21
7.5.7: Pitch Unit Selection.....	22
7.5.8: Depth Unit Selection.....	23
7.5.9: Time Setting.....	24
7.5.10: System Unlock.....	25
7.5.11: Visibility Control.....	26
7.5.12: Speed Control.....	27
7.6: Receiver Maintenance.....	28

8: Display	29
8.1: Specifications.....	29
8.2: Display Operations.....	29
8.3: Icons.....	30
8.3.1: Main Page Icons.....	30
8.3.2: Secondary Page Icons.....	31
8.3.3: Setup Page Icons.....	31
8.3.4: Down Hole Echo Mode Change.....	32
8.3.5: Radio Channel Selection.....	34
8.3.6: Pairing.....	35
8.3.7: Pitch Unit Selection.....	36
8.3.8: Distance Unit Selection.....	37
8.3.9: Visibility Control.....	38
8.3.10: Communication Mode.....	39
8.4: Display Maintenance.....	40
9: Transmitter	41
9.1: Introduction.....	41
9.2: Specifications.....	41
9.3: Digital Information.....	45
9.4: Transmitter Maintenance.....	45
10: Locating Methods	46
10.1: Three Point Locating.....	46
10.1.1: The Basics.....	46
10.1.2: Finding the Front Locate Point.....	48
10.1.3: Finding the Rear Locate Point.....	51
10.1.4: Finding the Locate Line and Transmitter.....	53
10.1.5: Tracking on the Fly.....	55
10.2: Bore-To.....	57
10.3: Single Point Locating.....	59
11: Battery and Charger	60
12: Warranty	60

1: Introduction

The MAG 3S and 6S are locating systems designed to assist horizontal directional drill machine operators in locating and tracking underground drill head locations and orientations. The systems consist of a **transmitter**, a **receiver**, and a remote **display**.



The **transmitter** sends digital information of the transmitter's pitch, roll, temperature, and battery status through an FM modulated RF signal.



The **receiver** receives this information and uses RF signal to identify the transmitter's status and location.









The receiver transmits the locating information to a remote **display** through a radio telemetry system. A horizontal directional drill machine operator can use the information from the display to guide the drill head to the desired path.



These locating systems also offer four channel license free radio telemetries between the receiver and remote display. The user can easily “pair” any two receivers and displays so that communications between the “pair” will not be interfered by other “pairs”.

This manual is intended to provide information and instructions on how to use these locating systems properly. Underground Magnetics Inc. (UM) reserves the right to improve the locating systems and the Operator's Manual at any time without notice.

2: Caution

-  The operator must understand safety procedures and correct operation methods before operating the HDD and the locating system.
-  HDD machines can cause property damage and personal injury upon striking underground power lines, gas lines, phone lines, television cables, fiber optic cables, or sewage lines. Make sure to confirm and mark all underground utilities before beginning operations.
-  Do not use the locating system near flammable or explosive substances.
-  Wear proper personal protective equipment including steel-toed boots, safety gloves, helmets, reflective vests, and safety goggles.
-  Obey all local safety regulations.
-  This locating system is only a tool to assist the operator to locate the drill head. It is the operator, not the Mag 6S locating system that is responsible for identifying the drill head location. UM is not responsible for any damage or loss caused by using the Mag 6S system. Operators should operate the Mag 6S system according to the manual.
-  If there are any questions, please contact UM at **support@undergroundmagnetics.com** or call customer service at **515-505-0960**.

3: FCC Compliance Statement

- This device complies with Part 15 of the FCC Rules. Operation is subject to the following two conditions:
 - This device may not cause harmful interference, and
 - This device must accept any interference received, including interference that may cause undesired operation.

- Changes or modifications not expressly approved by Underground Magnetics Inc. will void the user's authority to operate the equipment.

- Note: This product has been tested and found to comply with the limits for a Class B digital device, pursuant to Part 15 of the FCC Rules. These limits are designed to provide reasonable protection against harmful interference in a residential installation. This product generates, uses, and can radiate radio frequency energy and, if not installed and used in accordance with the instructions, may cause harmful interference to radio communications. However, there is no guarantee that interference will not occur in a particular installation. If this product does cause harmful interference to radio or television reception, which can be determined by turning the equipment off and on, the user is encouraged to try to correct the interference by one or more of the following measures:
 - Reorient or relocate the receiving antenna.
 - Increase the separation between the equipment and receiver.
 - Connect the equipment into an outlet on a circuit different from that to which the receiver is connected.
 - Consult the dealer or an experienced radio/TV technician for help.

4: Tips for Reading this Manual

Here are some points to keep in mind as you read through the Mag 3S & 6S Operator's Manual.

Page References

This question mark and textbox will tell you the page in the Operator's Manual where you can find more detailed information on the corresponding topic.



- The following two pages contain a short preface. This will be a quick introduction to the steps in which you will most likely use your Mag 3S or 6S System. It will also contain page references for the later sections of the manual that contain more detailed information for the corresponding steps.
- The rest of the manual will contain detailed sections that follow the order of the Mag 3S or 6S Receiver and the Mag D3 or D6 menu screens.
- It is recommended to read the whole Operator's Manual first. Then use the separate Quick Start Guide, which is included with your system, as reference when needed.

5: Preface

When you receive your Mag 3S or 6S System the transmitter will have already been activated, preprogrammed at 19 kHz, and paired and calibrated with the receiver. The receiver and display will have been paired and set to channel 1.

1 Turn on receiver by holding power button until the Mag logo is visible on screen.



Page 8

2 Walk bore-path and use depth forecasting to check for interference and select frequency.



Page 15

3 Install batteries into transmitter. Install battery cap with provided battery cap tool.



Page 44

4 Turn on display by holding power button until the Mag logo is visible on screen.



Page 28

5 Install transmitter into the housing.

6 Check calibration by placing receiver 10ft away from housing, measured from inside edge of receiver to center of housing.



Page 13

7 If distance on receiver's screen reads anything other than 10ft, perform calibration.



Page 13

8 Begin drilling.

9 Locate FLP (Front Locate Point).



Page 47

10 Locate RLP (Rear Locate Point).



Page 50

11 Locate LL (Locate Line).



Page 52

Repeat steps 9 through 11 as you continue to guide drill.

6: System Highlights

Mag 3S System

- High precision and high anti-interference Faraday shield 3D antenna structure
- Industrial rated, gold-plated electronic modules
- High-performance DSP
- Dual locating system, functioning as two receivers independently tracking to provide better accuracy and reliability
- Up to 130ft depth range and up to 48 hours continuous usage



Receiver: Mag 3S

Display: Mag D3

**Transmitter: Echo 1
Echo 1 19k
Echo 1 30k
Echo ST**

Mag 6S System

- High precision and high anti-interference Faraday shield 3D antenna structure
- Industrial rated, gold-plated electronic modules
- High-performance DSP
- Dual locating system, functioning as two receivers independently tracking to provide better accuracy and reliability
- Up to 190ft depth range and up to 160 hours continuous usage

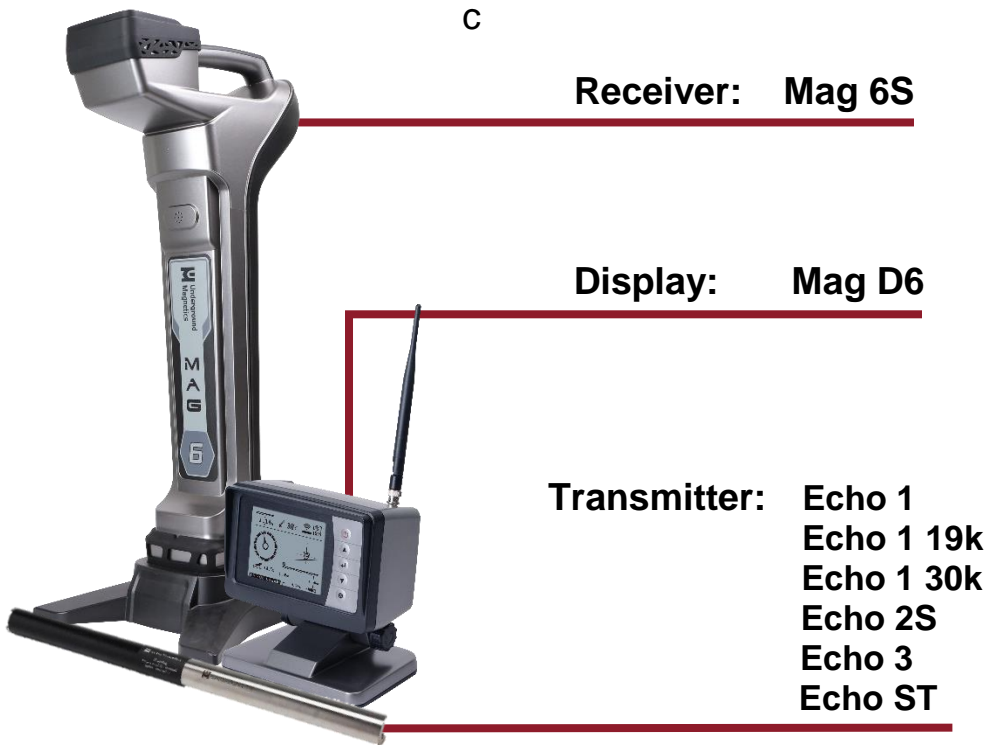

7: Receiver

7.1: Specifications

Mag 3S and 6S



System frequency	4kHz, 19kHz, 30kHz
Water resistant	IP65
Temperature range	-4° to 140°F
Telemetry	4 radio channels with range up to 3000 feet
Rechargeable lithium battery	12.5V
Battery life	Up to 50 hours
Dimensions	27" x 5" x 12"
Weight	6.5 pounds

7.2: Receiver Operation



Power key: Press and hold to turn on or off. Tap to turn backlight on or off.



Up key: Move to previous cursor selection.



Down key: Move to next cursor selection.



Confirm key: Tap to confirm cursor selection. Press and hold to enter secondary page. Tap from main page to enter Bore-To mode.



Setup key: Tap to enter calibration page/ return to main page. Press and hold to enter setup page.

7.3: Icons

7.3.1: Main Page Icons

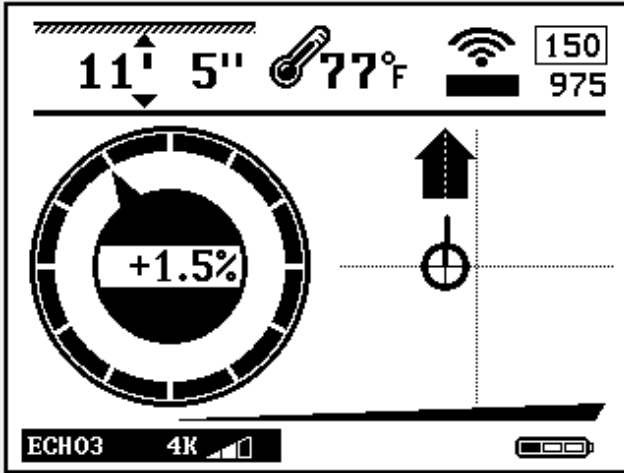

ECHO3 4K

- Transmitter model, frequency, and power

975

- Transmitter signal strength



- Signal to noise ratio bar and noise number



- Transmitter battery status



- Transmitter temperature (Flashing indicates transmitter is over-heating)

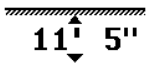

- Distance between transmitter and receiver

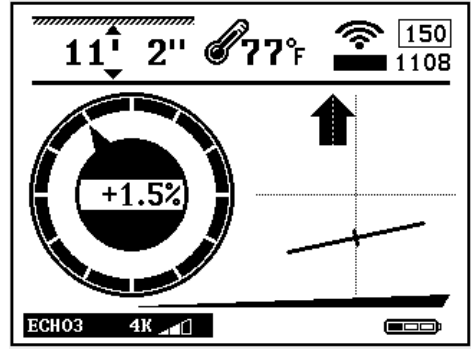
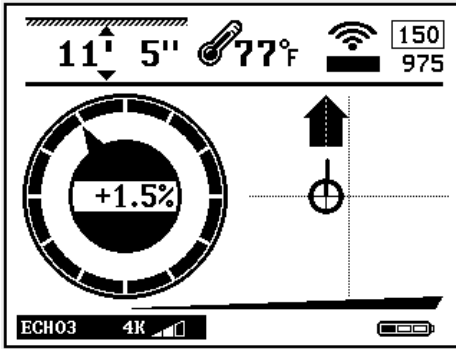

Roll indicator



24 clock positions



Direction of nearest Locate Point



Point: direction of transmitter

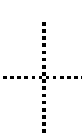

Ball: representation of Locate Point

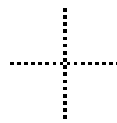

Representation of receiver location

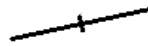

Locate Line

+1.5% Pitch

The Locate Line will be seen on screen when further away from the Locate Point.

Once close enough, the ball will appear and can be used to fine-tune the left-right position of the LP.



Page 48

7.3.2: Secondary Page Icons

To enter the Secondary Page, press and hold 

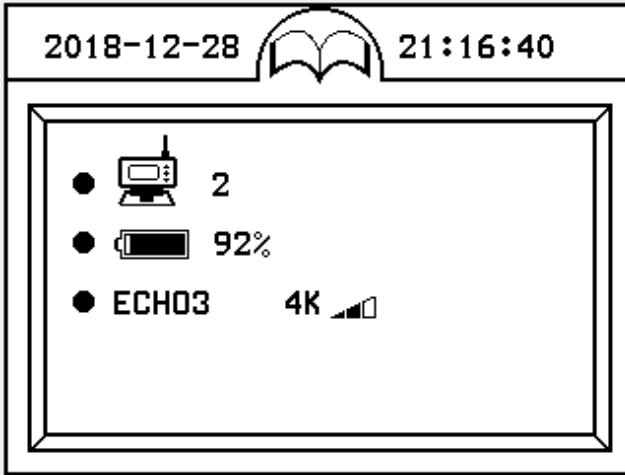

Radio channel



Receiver battery status



Transmitter model,
frequency, and power

7.3.3: Calibration and Depth Forecast Page Icons

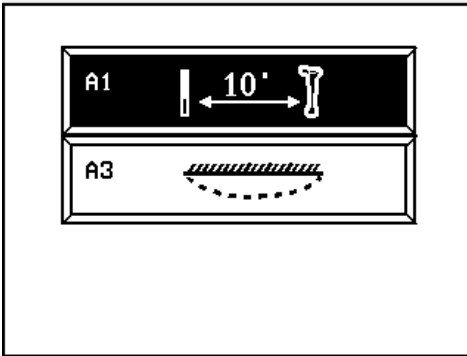

A1 : 10ft calibration

A3 : Depth prediction

7.3.4: Setup Page Icons

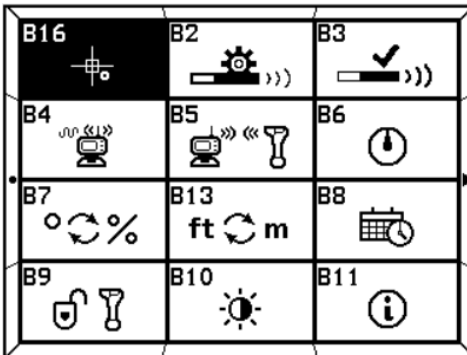

B1: Transmitter activation

B2: Transmitter settings

B3: Receiver settings

B4: Radio channel selection

B5: Receiver and display pairing

B6: Roll calibration

B7: Pitch unit selection

B8: Time setting

B9: System lock/unlock

B10: Visibility control

B11: System info

B13: Distance unit selection

B16: Speed Control

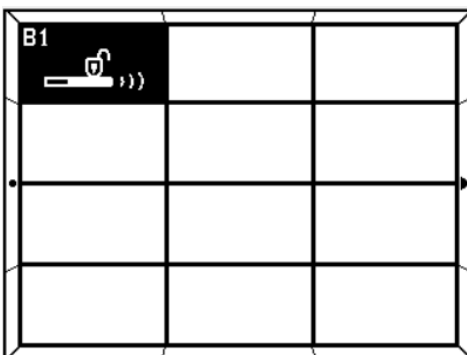

7.4: Calibration

7.4.1: Depth Calibration (10ft)

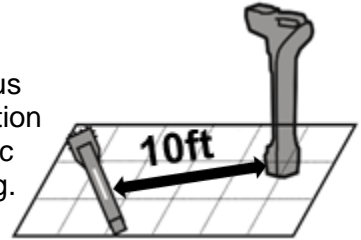

Warning

Even if the transmitter's roll, pitch, battery status and temperature are displayed correctly, calibration may not be reliable due to a distorted magnetic field. Make sure pitch is at 0% while calibrating.

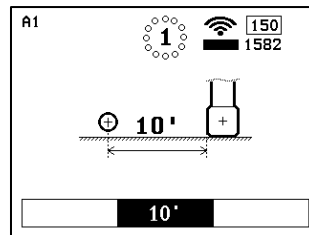
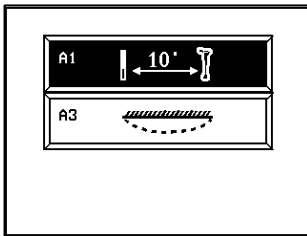

1. Make sure that the transmitter is working properly. Place it in the housing.
2. Place housing containing the transmitter in a location away from interference.
3. Set transmitter and receiver 10ft apart from center of transmitter to inside edge of receiver's base, as shown.



4. Tap  to enter Calibration and Depth Forecast Page
5. Tap  once to enter Calibration Page, and twice more to begin 10ft calibration.

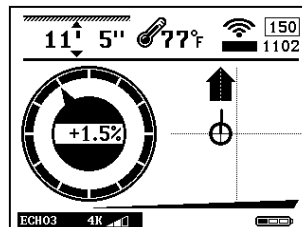
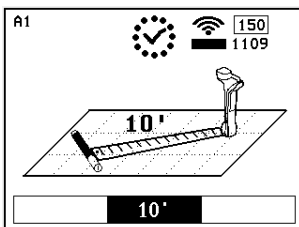

7. Calibration complete.
8. Tap  to return to Main Page.

7.4.2: Roll Calibration

1. Place transmitter housing in a 12 o'clock position.

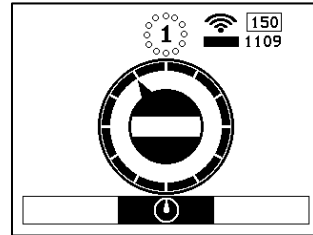
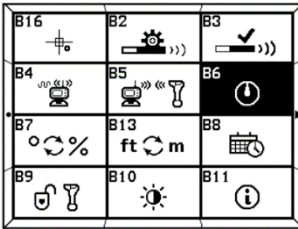

2. Press and hold to enter Setup page and tap to select B6 icon.
3. Tap to enter Roll Calibration Page and tap or until the point is in the 12 o'clock position. Tap twice to start roll calibration and wait for calibration to complete.

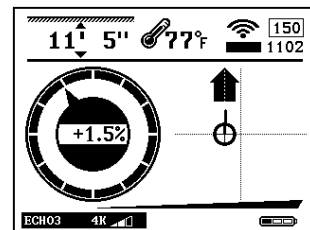
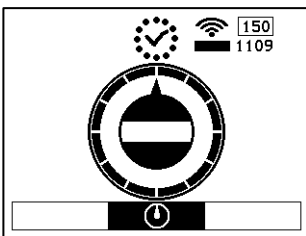



4. Calibration complete.
5. Tap to return to Main Page.

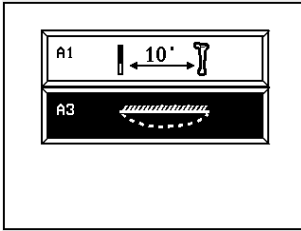

7.5: Operation

7.5.1: Depth Forecast

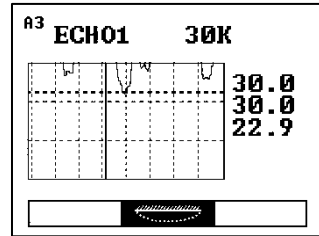

1. Tap  to enter calibration page and tap  to select A3 icon.



2. Tap  to enter Depth Forecast Page. Best-case, average, and worst-case depth forecast values are listed on the right while transmitter model and frequency are listed at the top. Tap  to reset forecast.

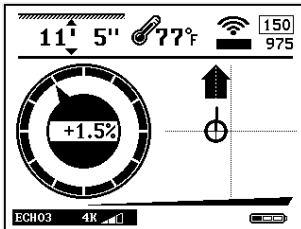

3. Tap  to return to Main Page.

Note: The best-case depth forecast value is a conservative value and will be the main value used when determining interference.

7.5.2: Transmitter Activation (For dealer or factory use)

(Process must be started within 10 minutes after batteries have been placed in the transmitter.)

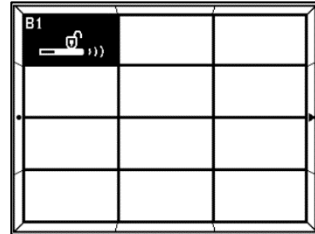
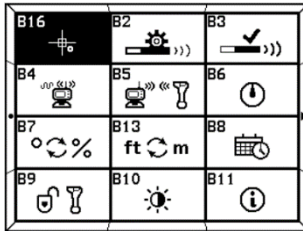

1. Press and hold to enter Setup Page.
2. Tap to scroll through the page options until B1 is highlighted. Then tap to enter Transmitter Activation Page.

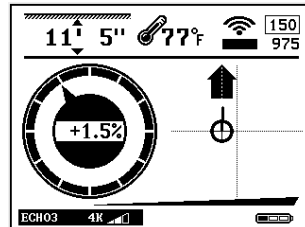
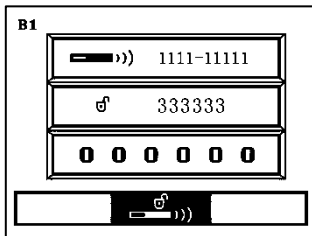

3. 1111-1111 is the transmitter identification number and 3333-3333 is the prompt code in the diagram. Send the transmitter identification number and the prompt code to the dealer. The dealer will give you an activation password. Use and to input a number and to move to the next number spot. Tap once done to confirm.
4. Tap to return to Main Page.

7.5.3: Transmitter Settings

(Process must be started within 10 minutes after batteries have been placed in the transmitter.)

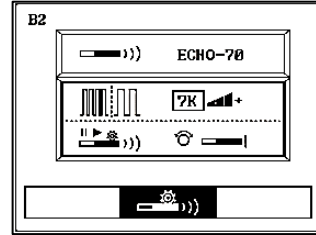
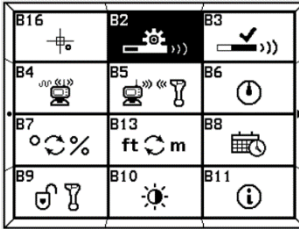

1. Press and hold to enter Setup Page and tap to select B2 icon.

2. Tap to enter Transmitter Settings Page. The receiver and Echo transmitter will automatically pair. Then tap or and to select frequency and power level. Tap to highlight Wake Up Mode and tap to enter. Then tap or to select desired mode.

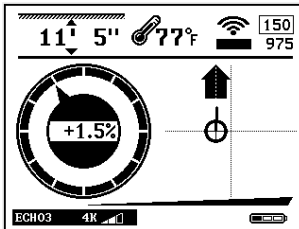

3. Tap to return to Main Page.

Instant
(rotate the transmitter 4 degrees or change the pitch by 1 degree)

360 degrees
(rotate the transmitter a full 360° several times)

Always on

7.5.4: Receiver Settings

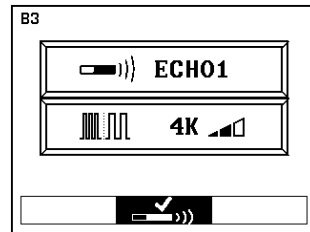
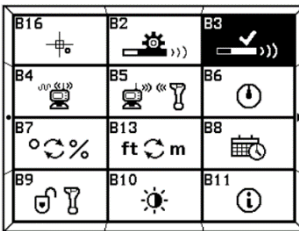

1. Press and hold to enter Setup Page. Tap to select B3 icon.
2. Tap to enter Receiver Settings Page. Tap or and to select transmitter model, frequency, and power.

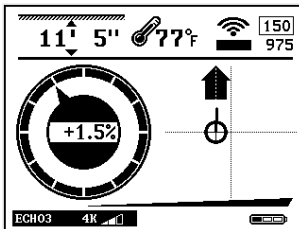

3. Tap to return to Main Page.

7.5.5: Radio Channel Selection

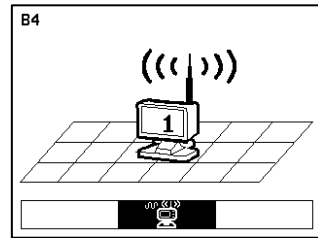
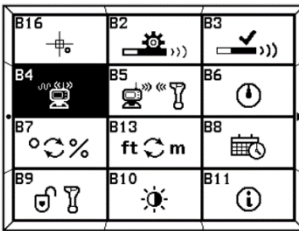

1. Press and hold to enter Setup Page. Tap to select B4 icon.
2. Tap to enter Radio Channel Page. Use or to select radio channel.

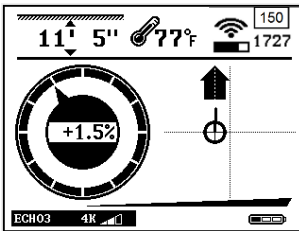

3. Tap to return to Main Page.

7.5.6: Pairing

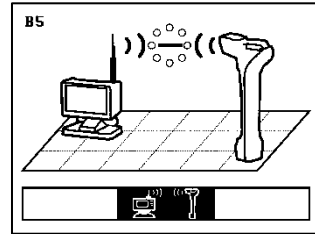
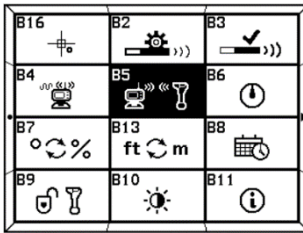



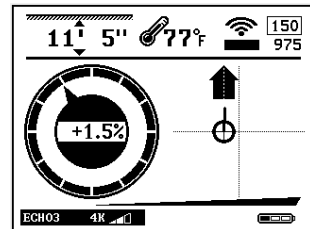
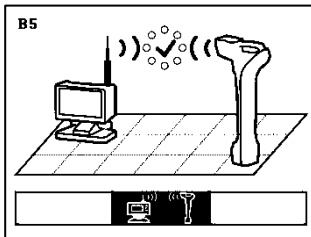

1. Press and hold to enter Setup Page. Tap to select B5 icon.
2. Tap to enter Pairing Page. Tap to start pairing. (It is required that these last two steps are performed on the display at the same time.)



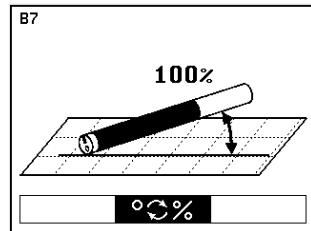
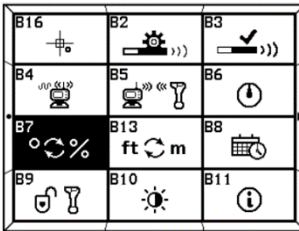

3. Pairing complete.
4. Tap to return to Main Page.

7.5.7: Pitch Unit Selection



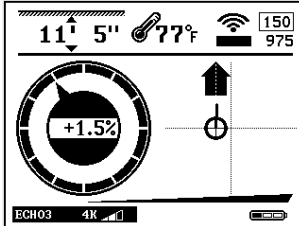





1. Press and hold  to enter Setup Page and tap  to select B7 icon. Tap  to enter Pitch Unit Selection Page.
2. Tap  to switch pitch mode.

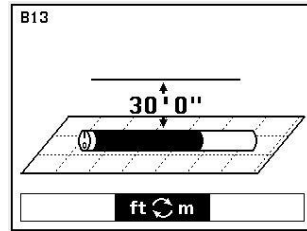
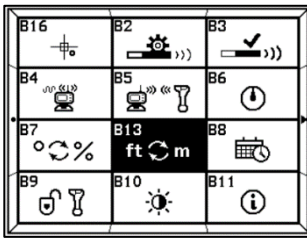



3. Tap  to return to Main Page.

7.5.8: Distance Unit Selection

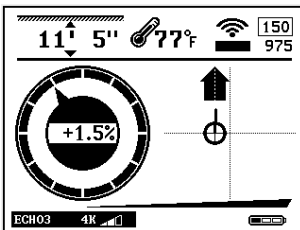

1. Press and hold  to enter Setup Page. Tap  to select B13 icon.
2. Tap  to enter Distance Unit Selection Page. Tap  or  to select unit and format.



3. Tap  to return to Main Page.

7.5.9: Time Setting (For dealer or factory use)

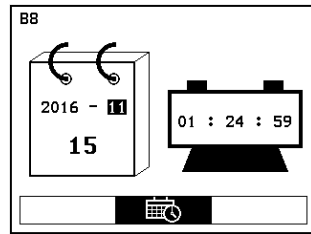
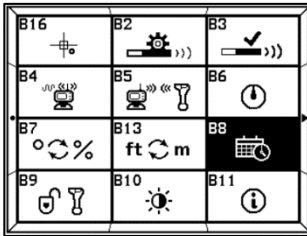

2. Press and hold to enter Setup Page. Tap to select B8 icon.
3. Tap to enter Time Settings Page. Tap to select year, month, day, hour, or minute. Tap or to set time.

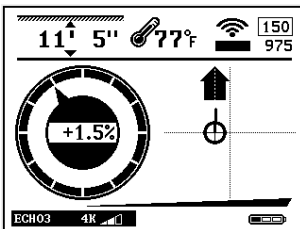

4. Tap to return to Main Page.

7.5.10: System Unlock (For dealer or factory use)

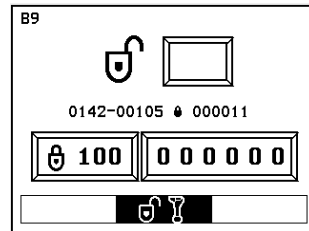
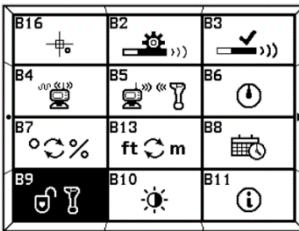



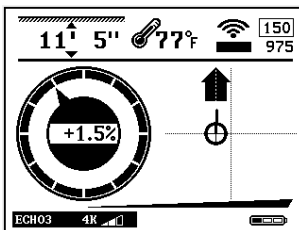



1. Press and hold to enter Setup Page and tap to select B9 icon. Tap to enter System Unlock Page.
2. Tap or and to input password.

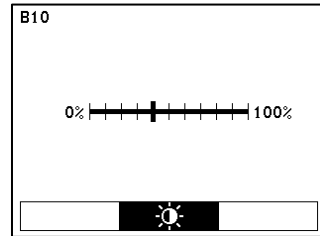
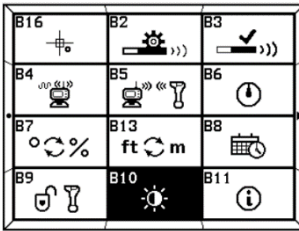



4. Tap to return to Main Page.



7.5.11: Visibility Control

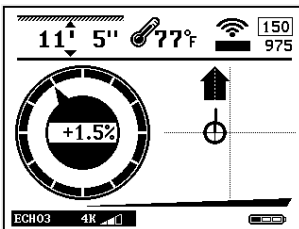

1. Press and hold  to enter Setup Page and tap  to select the B10 icon. Tap  to enter Visibility Control.
2. Tap  and  to adjust.





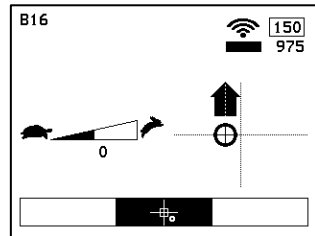
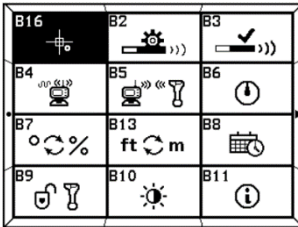

3. Tap  to return to Main Page.

Note: By holding both  and  at the same time while turning the receiver on, the visibility control will reset to normal visibility.

7.5.12: Speed Control



2. Press and hold  to enter Setup Page and tap  to enter the Speed Control Page.
3. Tap  and  to adjust speed.

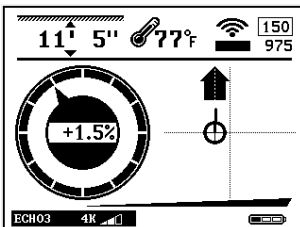

4. Tap  to return to Main Page.

Note: Adjusting the speed control allows operators to more easily fine tune the left-right bar and bore indicator for when at very deep depths.

7.6: Receiver Maintenance

- The receiver uses rechargeable lithium batteries. The receiver will automatically shut off if no key is pressed for over a period of 20 minutes or if there is no information received from the transmitter. It is strongly recommended that the batteries are taken out of the receiver if it is not being used for a long period of time to avoid potential corrosion.
- The receiver is an electronic measurement device. Severe shock and impact can damage the housing and the electronics inside the housing.
- Keep the receiver away from excessive heat to avoid damages to the plastic housing and the electronics inside the housing.
- Do not soak the receiver in excessive amounts of water.



8 Display

8.1: Display Specifications

Mag D3 and D6



Radio frequency	915MHz
Water resistant	IP65
Temperature range	-4° to 140°F
Telemetry	4 radio channels with range up to 3000 feet
Power	Rechargeable lithium batteries
Battery life	Up to 50 hours
Screen	Industrial rated LCD graphic display
Dimensions	7.5" x 5" x 7.5"
Weight	3.3 pounds

8.2: Display Operations



Power key: Press and hold to turn on or off. Tap to select level of backlight.



Up key: Move to previous cursor selection.



Down key: Move to next cursor selection.



Confirm key: Tap to confirm cursor selection. Press and hold to enter secondary page.



Setup key: Tap to return to main page. Press and hold to enter setup page.

8.3: Icons

8.3.1: Main Page Icons

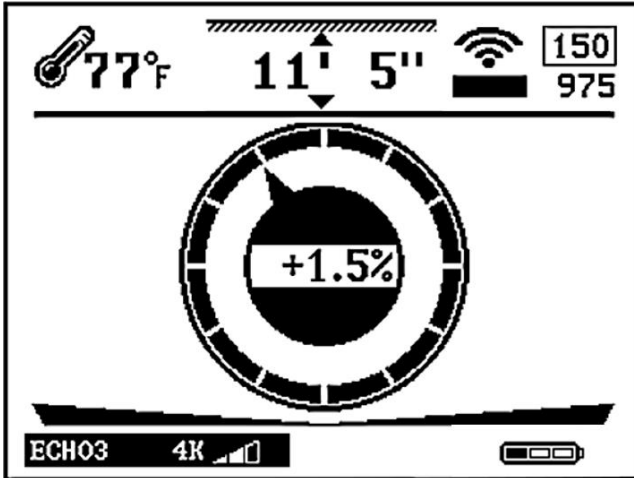

ECH03 4K

- Transmitter model and frequency

975

- Transmitter signal strength



- Signal to noise ratio bar and noise number



- Transmitter temperature (Flashing indicates transmitter is over-heating)



- Transmitter battery status



- Distance between transmitter and receiver



+1.5%

- Transmitter pitch

8.3.2: Secondary Page Icons

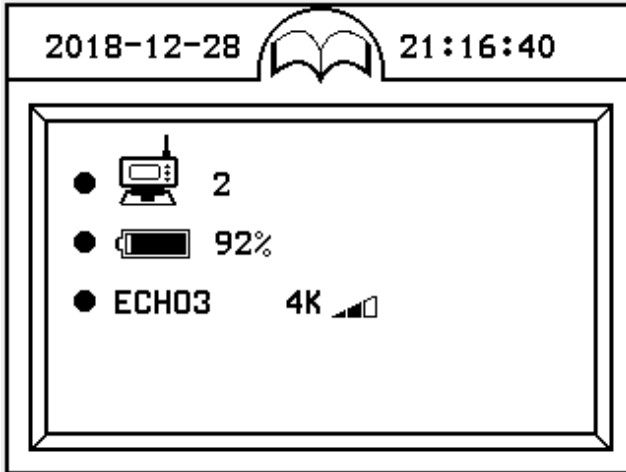
To enter the Secondary Page, press and hold 



- ECH03** **4K**  Transmitter model, frequency, and power
-  **92%** Display battery status
-  **2** Radio channel

8.3.3: Setup Page Icons

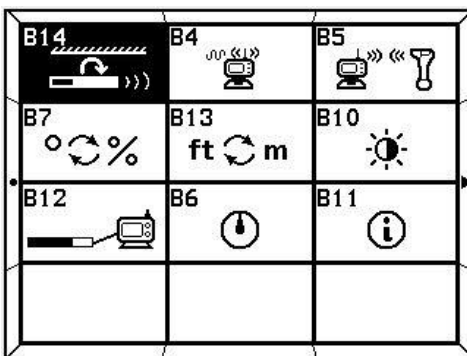

- B4:** Radio channel selection
- B5:** Receiver and display pairing
- B7:** Pitch unit selection
- B10:** Visibility control
- B11:** System info
- B12:** Display communication mode
- B13:** Distance unit selection
- B14:** Down hole Echo mode change

8.3.4: Down Hole Echo Mode Change

(Mag 6S only: Echo 2S and Echo 3)

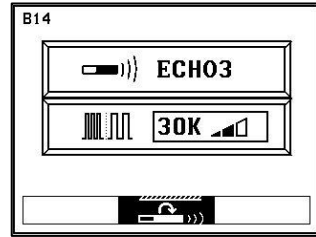
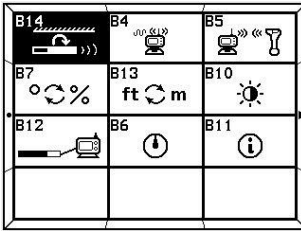

1. Press and hold to enter Setup Page. Tap to enter Down Hole Echo Mode Change Page.
2. Use or to select desired frequency and power levels. Tap to begin mode change process.

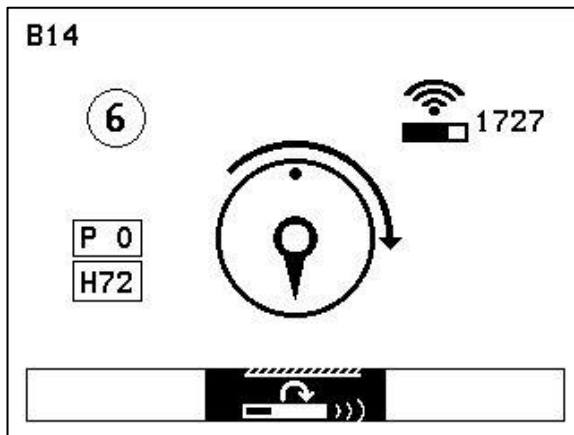

Roll indicator



Steps remaining



Target dot



Instructions



Hold: hold this roll position until it counts down to 0



Proceed: time left to proceed in process by rotating to new roll position in sequence

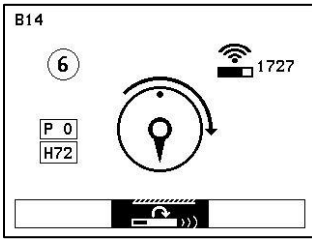

Rotate drill head until roll indicator points toward target dot. Instructions will change from the clockwise arrow to “STOP”.

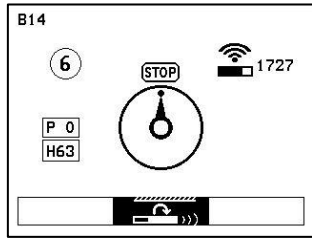

Hold this position until “H” counts down to 0.

Rotate drill head to next position in sequence before “P” counts down to 0 or the sequence will be canceled.

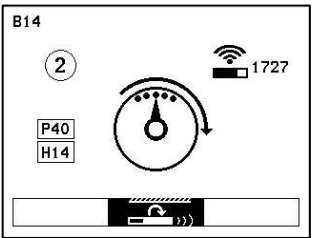

If the next step has the target dots in the same place as the previous step, rotate the drill head one entire rotation until the roll indicator lines up with the target dots again.

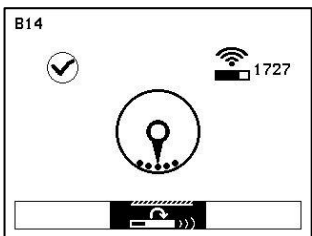
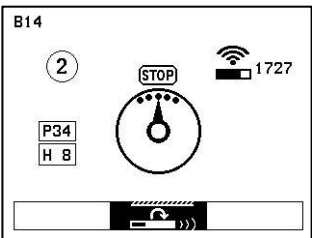

Once all six steps of the sequence are complete, change the Transmitter Settings on the receiver to match the new frequency and power levels.



Page 18

8.3.5: Radio Channel Selection

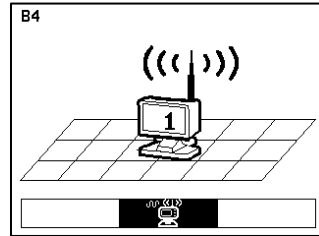
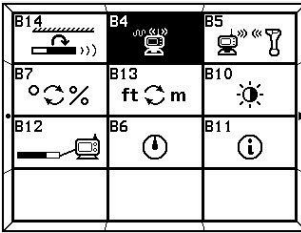



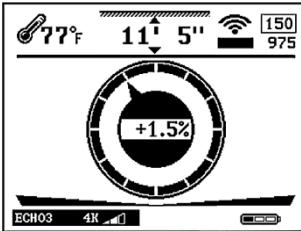

1. Press and hold to enter Setup Page.
Tap to enter Radio Channel Page.
2. Use to select radio channel.



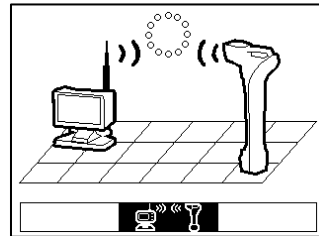
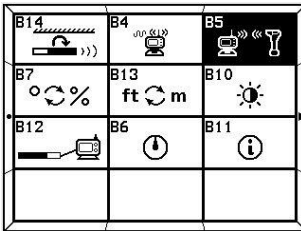

3. Tap to return to Main Page.

8.3.6: Pairing



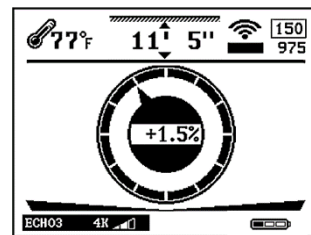
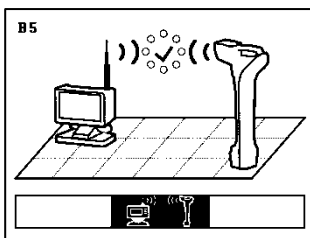



1. Press and hold  to enter Setup Page and tap  to select B5 icon. Tap  to enter Radio Registration Page.
2. Tap  to start pairing. (It is required that the following procedure is performed on the receiver at the same time)

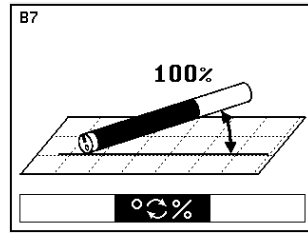
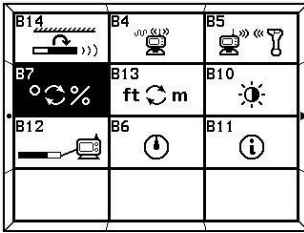

3. Pairing complete.
4. Tap  to return to Main Page.

8.3.7: Pitch Unit Selection





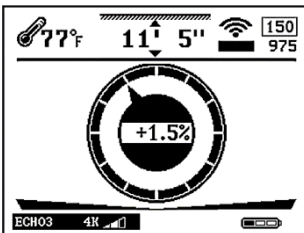



1. Press and hold  to enter Setup Page and tap  to select B7 icon. Tap  to enter Pitch Unit Selection Page.
2. Tap  to switch pitch mode.

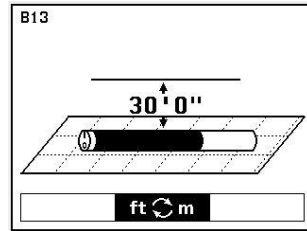
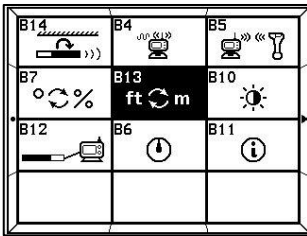



3. Tap  to return to Main Page.

8.3.8: Distance Unit Selection

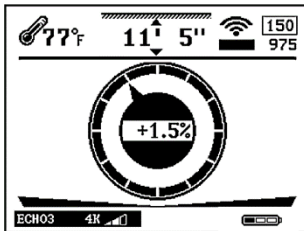

1. Press and hold  to enter Setup Page. Tap  to select B13 icon.
2. Tap  to enter Distance Unit Selection Page. Tap  or  to select unit and format.



3. Tap  to return to Main Page.

8.3.9: Visibility Control

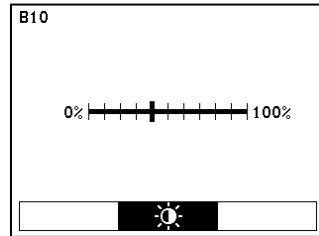
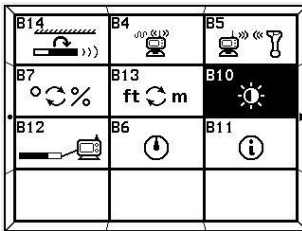

1. Press and hold to enter Setup Page and tap to select the B10 icon. Tap to enter Visibility Control Page.
2. Tap and to adjust.

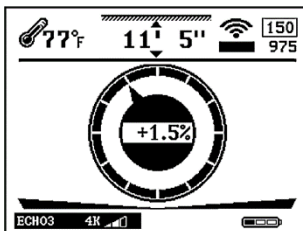



3. Tap to return to Main Page.

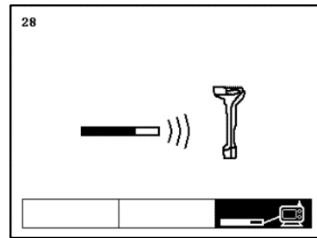
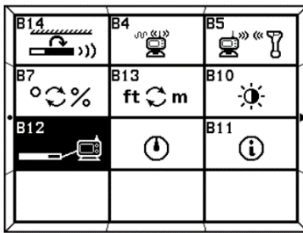

Note: By holding both and at the same time while turning the receiver on, the visibility control will reset to normal visibility.

8.3.10: Communication Mode

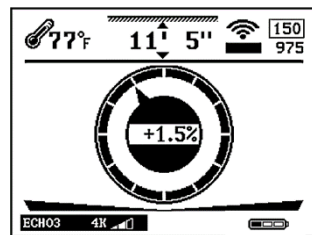
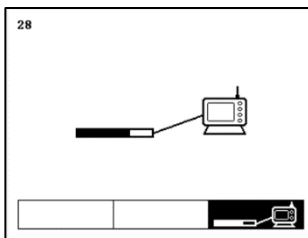

1. Press and hold  to enter Setup Page and tap  to select B12 icon. Tap  to enter Communication Mode Page.
2. The default communication mode will be wireless communication.



3. Press  to switch to cable mode.
4. Tap  to return to Main Page.

8.4: Display Maintenance

- The display uses rechargeable lithium batteries. The display will automatically shut off if no key is pressed for over a period of 20 minutes or if there is no information received from the receiver. It is strongly recommended that the batteries are taken out of the display if it is not being used for a long period of time to avoid potential corrosion.
- The display is an electronic measurement device. Severe shock and impact can damage the housing and the electronics inside the housing.
- Keep the display away from excessive heat to avoid damages to the plastic housing and electronics inside the housing.
- Do not submerge the display in excessive amounts of water.

9: Transmitter

9.1: Introduction

The transmitter provides drill head temperature, clock position, pitch, battery status and locating signal. The transmitter transmits signals at 4 kHz, 19 kHz or 30 kHz. The transmitter will enter a “sleep” mode after 15 minutes without rotation. It takes 10 seconds to “wake up” once the transmitter is rotated.

Note: If drilling in adverse soil conditions (i.e. rock), normal C cell batteries will experience battery chatter. This can greatly reduce battery life. To prevent this, use your provided double C lithium cell battery instead.

8.2: Specifications

Echo 1 (Mag 3S and 6S)

Weight	1.5lbs	
Dimensions	1.25" x 15" length	
Frequency	4kHz/19kHz/30kHz	
Depth Range	90ft/130ft/130ft	
Power	2 C cells, Echo Cell Kit, or Lithium Battery	
	C cell	3V, 12 hours of continuous usage
	Echo Cell Kit	3V, 20 hours of continuous usage
	Lithium*	3V, 48 hours of continuous usage
Roll	24 transmitter roll positions	
Pitch	0.1% resolution	
Temperature	Under 185°F	

Echo 2S (Mag 6S)



Weight	1.5lbs	
Dimensions	1.25" x 15" length	
Frequency	4kHz/19kHz/30kHz	
Depth Range	90ft/130ft/130ft	
Power	Echo Cell Kit or Lithium Battery	
	Echo Cell Kit	3V, 20 hours of continuous usage
	Lithium*	3V, 48 hours of continuous usage
Roll	24 transmitter roll positions	
Pitch	0.1% resolution	
Temperature	Under 185°F	
High Power Modes	<ul style="list-style-type: none"> • 19kHz and 30kHz depth range of 160ft • Operating time is 5 hours for Echo Cell Kit and 12 hours for lithium battery 	
Down Hole Mode Change	Able	 <div style="border: 1px solid red; border-radius: 10px; padding: 2px 10px; display: inline-block;">Page 32</div>

Echo 3 (Mag 6S)

Weight	2lbs	
Dimensions	1.25" x 19" length	
Frequency	4kHz/19kHz/30kHz	
Depth Range	90ft/130ft/130ft	
Power	2 Echo Cell Kits or 2 Lithium Battery Packs	
	Echo Cell Kit	3V, 50 hours of continuous usage
	Lithium*	6V, 160 hours of continuous usage
Roll	24 transmitter roll positions	
Pitch	0.1% resolution	
Temperature	Under 185°F	
Power + Mode	<ul style="list-style-type: none"> • 19kHz and 30kHz depth range of 190ft • Operating time is 12 hours for Echo Cell Kit and 40 hours for lithium batteries • Data update is slower but range is longer 	
Down Hole Mode Change	Able	 Page 32



Echo ST-DX (Mag 3S and 6S)



Dimensions	1" x 8" length
Frequency	30kHz
Depth Range	60 feet
Power	1 18650 3V rechargeable lithium battery
Roll	24 transmitter roll positions
Pitch	0.1% resolution
Temperature	Under 250°F

9.3: Digital Information

- Pitch: From -100% to +100% with 0.1% resolution within the range of -45% to +45% and 1.0% resolution outside of that range.
- Roll: 24 transmitter roll positions
- Battery: **Install batteries positive side down and install battery cap with provided battery cap tool.**
 - C cell: Battery full, 2/3 full, 1/3 full and flash warning
 - Lithium: Will show battery full then flash warning
- Temperature: When the transmitter is overheating, temperature indication in the receiver's display flashes. If temperature reaches over 185°F (120°C), transmitter may be permanently damaged. If this happens, the dot temperature indicator on the front of transmitter will turn black.

9.4: Transmitter Maintenance

- Do not place the transmitter near excessive temperature (over 185°F/120°C).
- Do not apply excessive pressure, shock or vibration on the transmitter.
- Take the battery out of the transmitter after use.
- Clean the spring and cap on the battery compartment when necessary.
- Regularly check the sealing ring on the battery cover. Replace if necessary.

10: Locating Methods

One major advantage of the Mag 3S & 6S systems is their simplicity. Once the receiver and transmitter are paired, the operator is not required to push any buttons to pinpoint the location, direction or depth of the transmitter.

10.1: Three Point Locating

10.1.1: The Basics

The Mag 3S or 6S receiver locates the transmitter by pinpointing three specific locations along the transmitter's magnetic field. The front locate point (FLP) ahead of the transmitter, the rear locate point (RLP) behind the transmitter and the locate line (LL) above the transmitter.

For the most accurate location and depth of the transmitter, both the FLP and the RLP should be located before locating the LL. The front and rear locate points, when lined up, indicate the exact direction of the transmitter. If the transmitter is level, the locate line will be located directly in-between the two points.

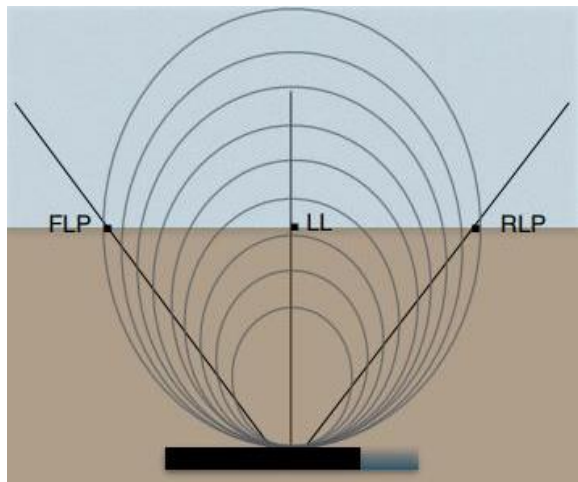

Side view

The Locate Line does not equal the location of the transmitter. The Locate Line extends left and right of the transmitter.

Think of the transmitter as an airplane. The FLP is the nose and the RLP is the tail. You can locate the LL left and right of the body, but that is not the center of the transmitter.

This is why you must locate both the FLP and RLP before the LL to get the most accurate depth and location.

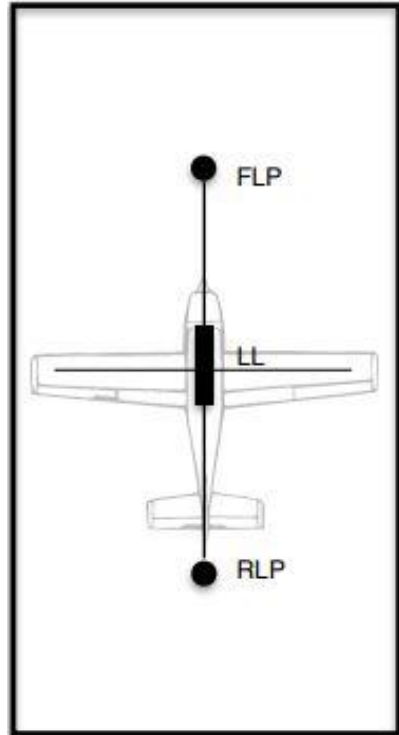

Top view

10.1.2: Finding the Front Locate Point

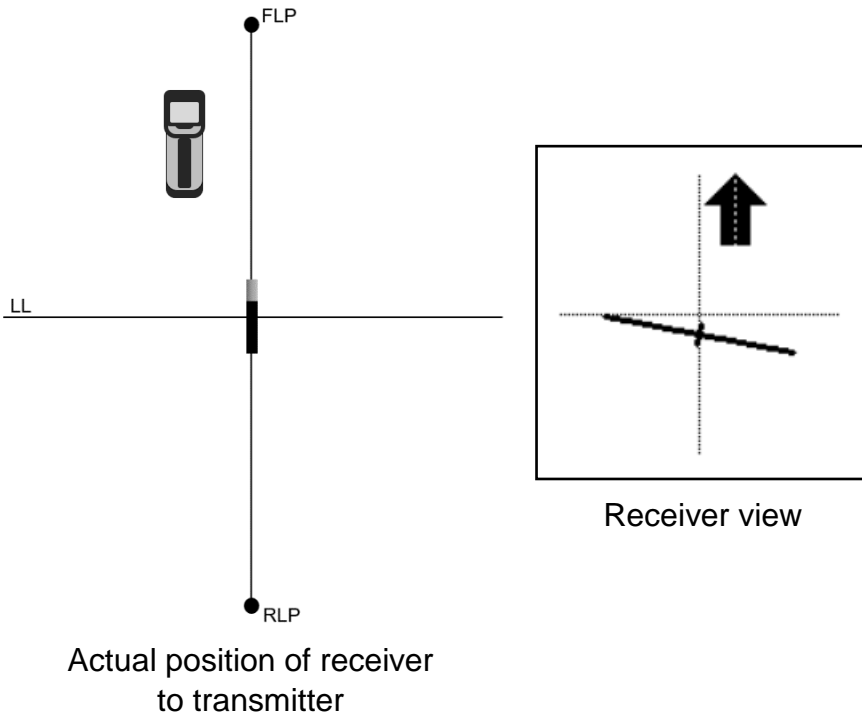

In this scenario the transmitter is behind you and you are walking toward the FLP.

Notice how the arrow that indicates the nearest locate point is slightly to the right and has a narrow base. Its position lets you know the FLP's right-left information relative to the receiver. The width of the base lets you know how close or far the FLP is from you. A skinnier base means you are further away, and completely filled in base means you're about to cross the FLP.

Walk forward until the base of the arrow is fully filled in.

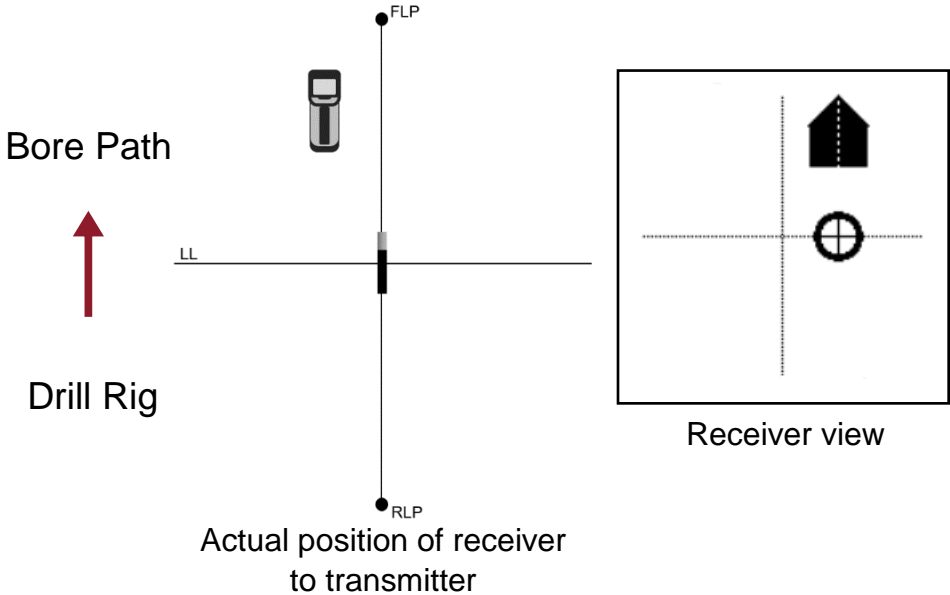

Notice how the Locate Line was replaced with a ball. The ball represents the FLP and appears when you are near it. It will slide along the horizontal axis of the cross hairs to give you the FLP's right-left location.

Where the cross hairs meet represents the receiver, the ball represents the FLP's position relative to the receiver, and the arrow represents the direction and nearness of the FLP, you can now see that you are about to cross over the FLP and that it is to your right.

Walk forward until the arrow shows two arrows on screen or flips. Then walk to the right to center the ball in the cross hairs. This is the exact location of the FLP.

Notice the line that is now on top of the ball. This is for single point locating and will be addressed later.

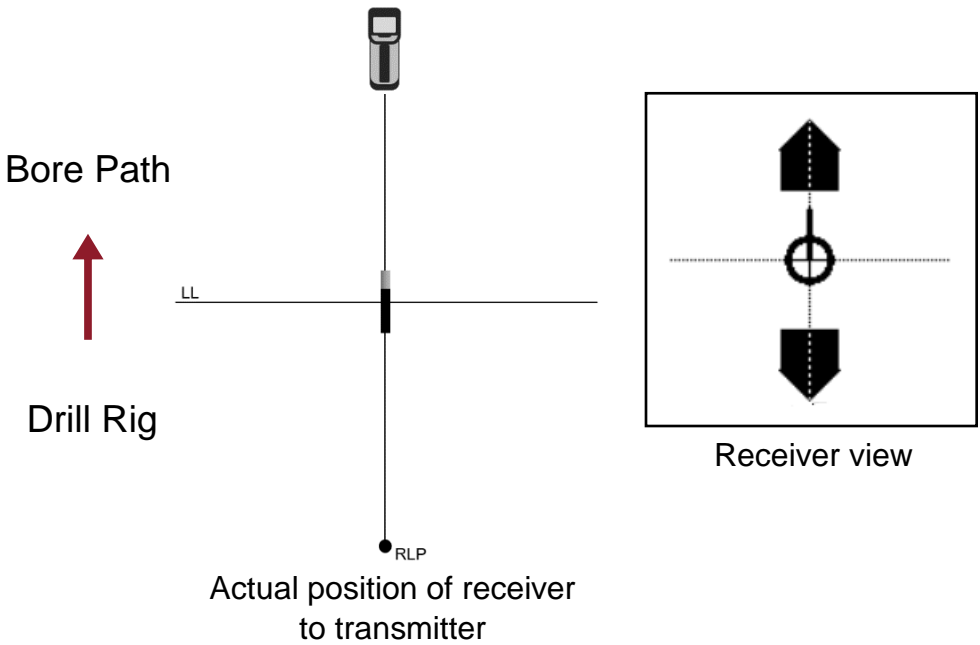

10.1.3: Finding the Rear Locate Point

Steps to locate RLP

1. Move the receiver back toward the drill until the arrow flips as shown in the receiver view below. The ball will have disappeared, and the LL indicator will have replaced it. When the arrow flips and the LL indicator lines up with the horizontal axis, you have crossed the LL.

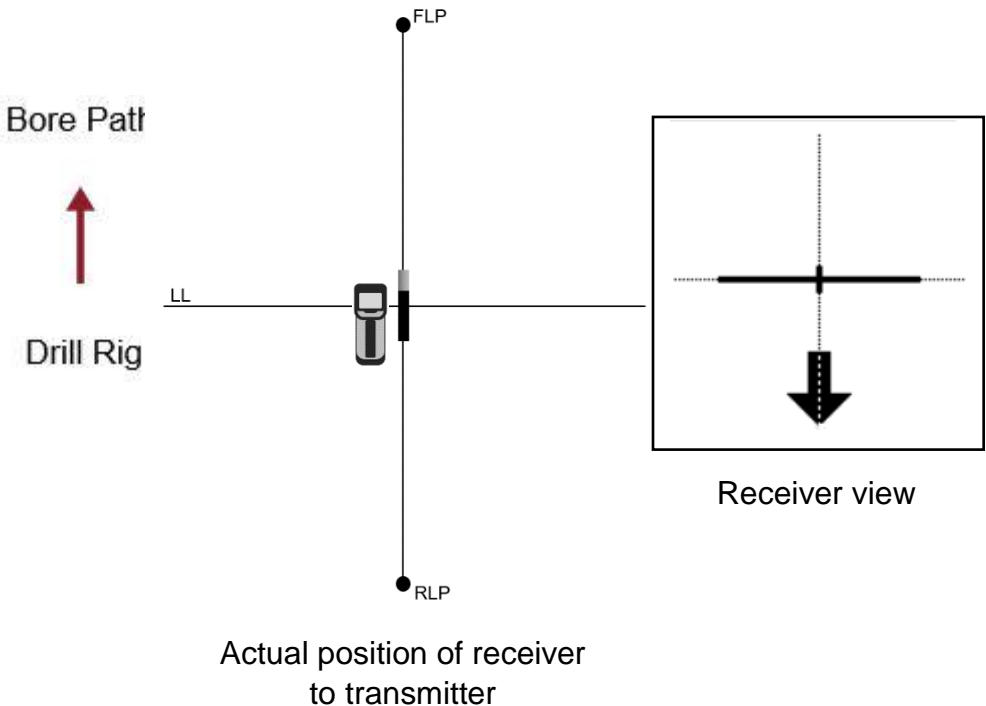

2. Continue to move back toward the drill. Watch the base of the arrow grow wider to indicate how close you are to the RLP. Once the base is completely full and the arrow either flips, or two arrows appear on the screen, you have crossed the RLP.
3. Fine tune the left-right position of the RLP by putting the ball in the cross hairs. This is the RLP.

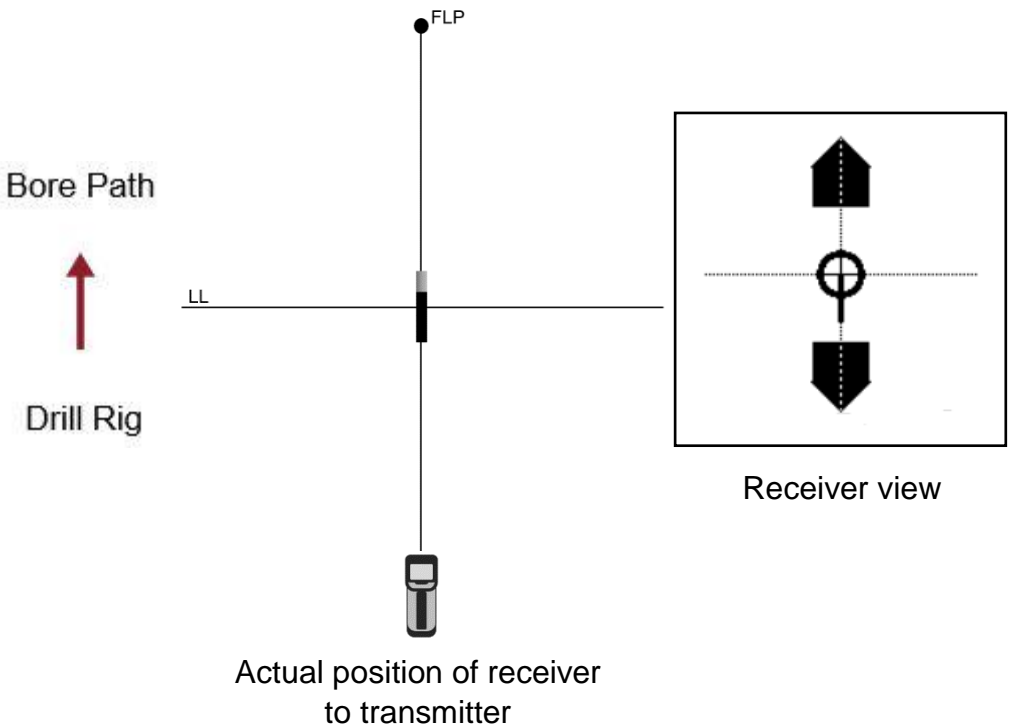

10.1.4: Finding the Locate Line and Transmitter

Now that the FLP and RLP have been marked, you're ready to locate the transmitter.

Steps to Locate LL

1. From the RLP walk toward the FLP. The ball will be replaced by the LL indicator, which will start to center as shown on the receiver view below.

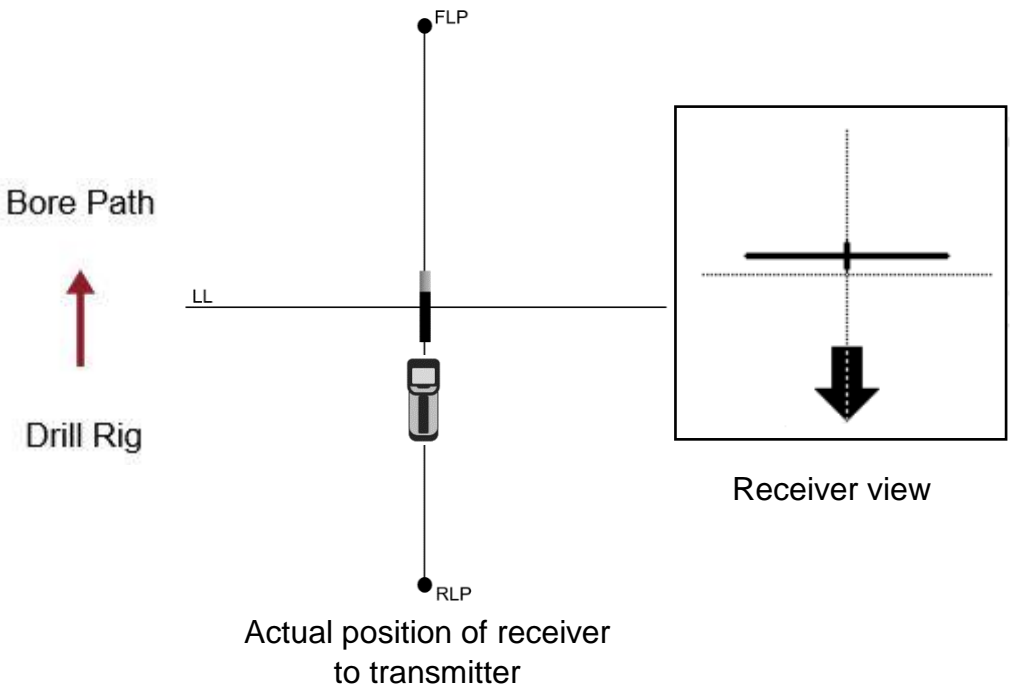

2. Once the LL is centered and the arrow flips, as shown below, you are directly over the head and you may mark the location and note depth.

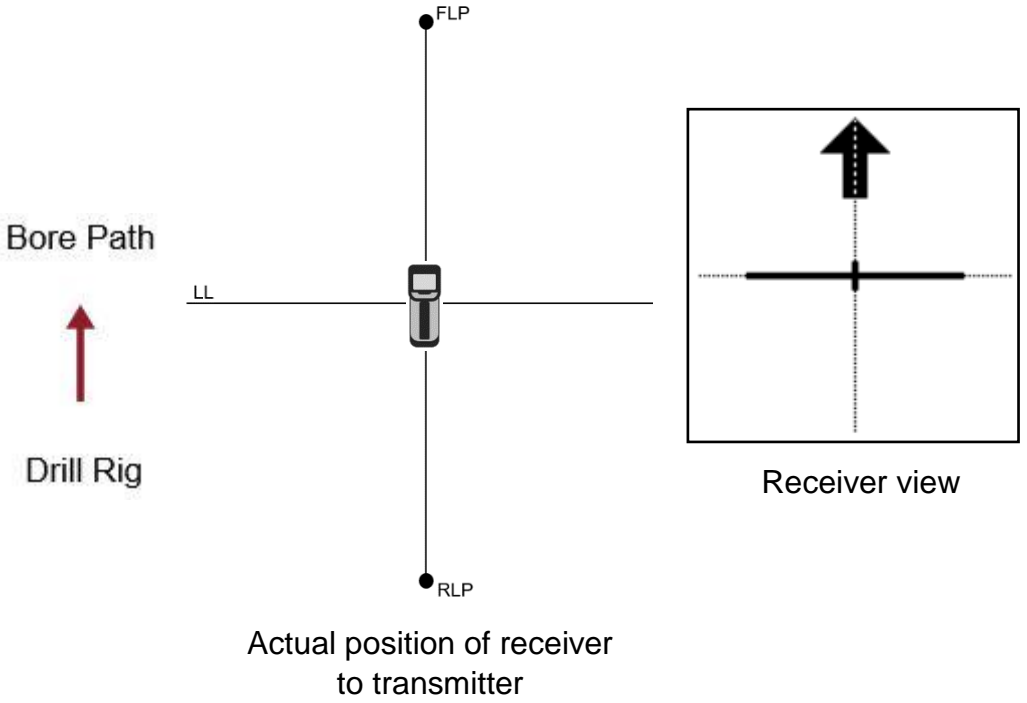

10.1.5: Tracking on the Fly

Tracking on the fly may be used once the bore path is established and level. This tracking method will increase locating speed and in turn the speed at which the bore can be completed.

As long as the FLP remains on target, there is no need to find the RLP on every rod. If steering is required, a quick look at both the RLP and the FLP will ensure the transmitter is still on target.

While tracking on the fly using 10' drill pipes the operator should walk forward from the last FLP approximately 10' and place the receiver down in line with the path created by the RLP and the FLP. While the drill operator is drilling toward the receiver, wait for the arrow to flip. You are within inches of the new FLP, put the ball in the cross hairs and mark the new FLP. Now simply walk back to the LL being careful to stay in line with your last FLP and mark the new location of the transmitter and record the depth.

Refer to diagram on the next page.

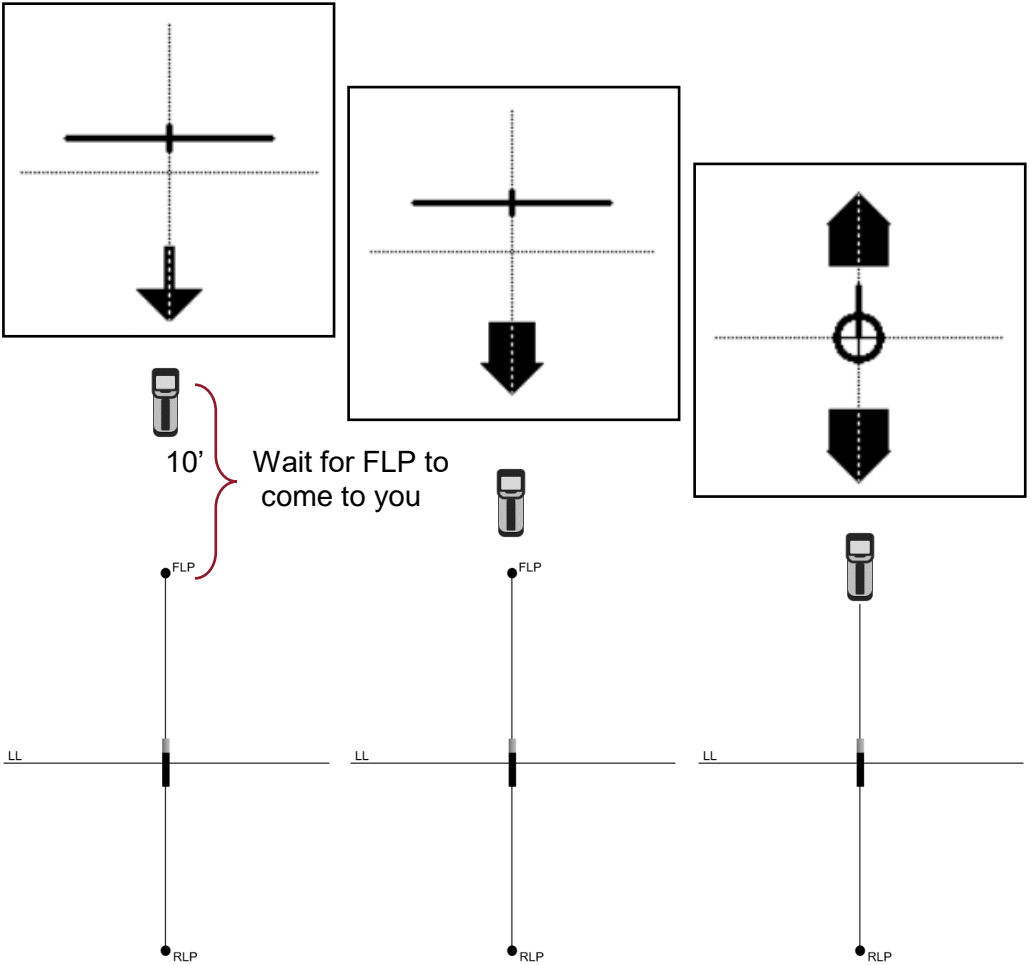

Note: Ignore the LL indicator until you are over the transmitter. It's only purpose when not over the transmitter is to show that you are not close enough to a locate point for the ball to appear. Do not use it to estimate the location of the transmitter when not over or very near to the drill head.

10.2: Bore-To

To switch the receiver to Bore-To mode, tap the  from the main page.

To return to Walkover mode, simply tap  again.

The display screen on both the receiver and the remote display will look like the screen to the right.

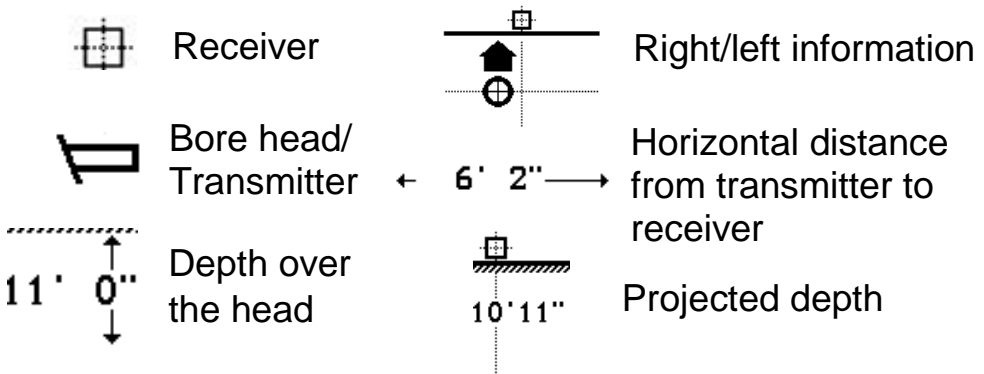
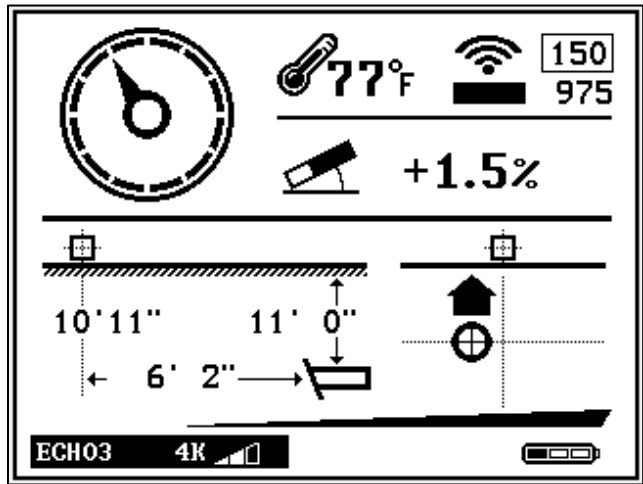

Projected Depth

Projected depth tells you what depth the head will be at when it reaches the receiver if the operator maintains the indicated pitch.

The Bore-To feature on the Mag 6S is very powerful. Operators can expect to receive good right-left steering, pitch, and roll information as far out as 100ft.

It is important to note that the depth is only a reference. As distance between the transmitter and receiver decreases, the accuracy increases.

Never cross existing utilities while in the Bore-To mode. Expose and verify visually while crossing utilities.

For best Bore-To results, the operator should locate up to the area that can't be walked over and mark both the FLP and RLP* before moving the receiver to the other side.

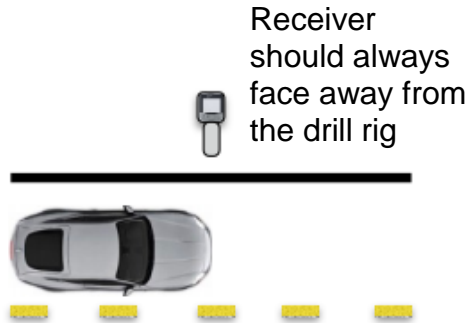

Once on the other side, place the receiver directly in-line and proceed with drilling using the right-left steering bar to keep the bore path in-line.

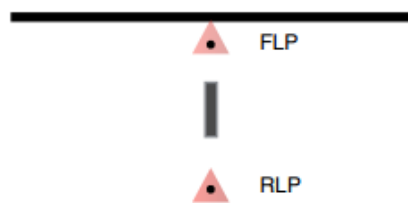

*It is best to place an object, like a traffic cone, at both the front and rear locate points so that a visual alignment can be viewed.

10.3: Single Point Locating

Single Point Locating is the newest and most efficient way to locate the drill head.

Simply walk forward until the base of the arrow fills in completely and the ball appears on screen. Once the arrow flips, place the ball in the cross hairs.

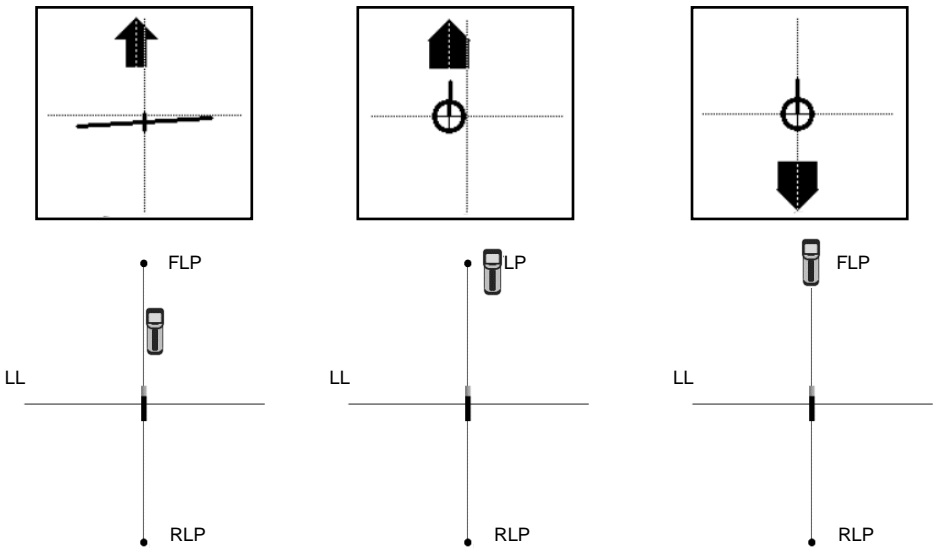

Notice that the ball has a line on top. This is the “point” in “Single Point”. The line points in the direction that the transmitter is pointing in.

You now have the location of the FLP and the direction of the transmitter.

Switch to Bore-To mode, walk a bore’s length forward in line with the point and wait for the FLP to come to you. Continue moving forward and locating the FLP to locate with just a single point.

11: Battery and Charger

- Mag receivers use lithium rechargeable batteries.
- This lithium rechargeable battery comes with a special charger. Any use of other lithium rechargeable battery or charger for the receiver may cause fire, explosion, leaking or other damages.
- Store the battery at the room temperatures; 59-77°F (15-25°C). Extreme high or low temperatures will shorten the battery life.
 - Do not submerge the battery in water or any other liquids.
 - Do not throw the battery into fire.
 - Do not disassemble the battery.
 - Avoid any kind of damage to the battery.
 - Please dispose of lithium properly.
- When charging the battery, the red light will shine. When charging is complete, a green light will shine.

12: Warranty

Underground Magnetics offers standard warranty on parts and labor for all Mag series locating systems and transmitters. Please contact our offices for more details on warranty periods.



Underground Magnetics

(515) 505-0960

Manuals can be found at:
www.umaghdd.com