



## SGConn® LEV (e-bike) Connectors



### Introduction

SGConn® Vehicle Electrical connectors meet waterproof rating from IP65 to IP67 in IEC60529 standard and are used in applications of Vehicle and e-bike industries for Battery charger, Controller, Indicator and Motor.

### Certifications and Membership

SGConn® Circular Connectors are built to the highest quality and specifications and fulfills European Union regulations for RoHS, UL and major worldwide safety requirements.



### Specifications

#### Material

- Contact: Copper Alloy, Gold Plated
- Connector Body: Nylon+GF, PC, UL Recognized

#### Temperature Range

- Connector Body: -40°C to +100°C
- Cable: -20°C to +80°C

#### IP Rating

- IP65
- IP66
- IP67

#### Contact Resistance

- ≤10mΩ

#### Insulation Resistance

- ≥30MΩ at DC 500V

#### Durability

- 100 cycles minimum

#### Breakdown Voltage

- ≥AC 1000V/ 1 minute

#### Corrosion

- 48 hours salt spray contact



# LEV (e-bike) Connectors

IP65 • IP66 • IP67

For Battery Charger, Indicator, Controller, and Motor

L04



**M5 1A: 4 pins**  
2MN3010, 2MN3012

L04



**M12 5A: 3/4/5pins; 2A: 8 pins**  
2MT30X0, 2MT30X2

## Indicator



## Controller

L05



**10A+2A: 3+3 pins; 10A+5A: 3+6 pins; 15A: 3 pins**  
2EB3004, 2EB3024

L05



**15A+2A: 2+11 pins**  
2EB3005, 2EB3025



L02



**60A+5A: 2+7 pins**  
2BA1010, 2BA1011



**40A**  
2BA1020, 21



**30A**  
2BA1018, 19

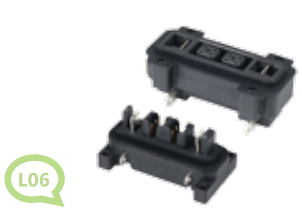

**20A+5A: 2+8 pins**  
2BA1031, 2BA1032



**20A+5A: 2+3 pins**  
2DS3002, 2DS3012



**10A+5A: 2+2 pins**  
2CT3020, 2CT3016



**10A: 3 pins**  
2CT3020, 2CT3016



**10A: 2pins**  
2CT1001



**30A+5A: 2+5 pins**  
2BA1029, 2BW1030



# Battery Charger

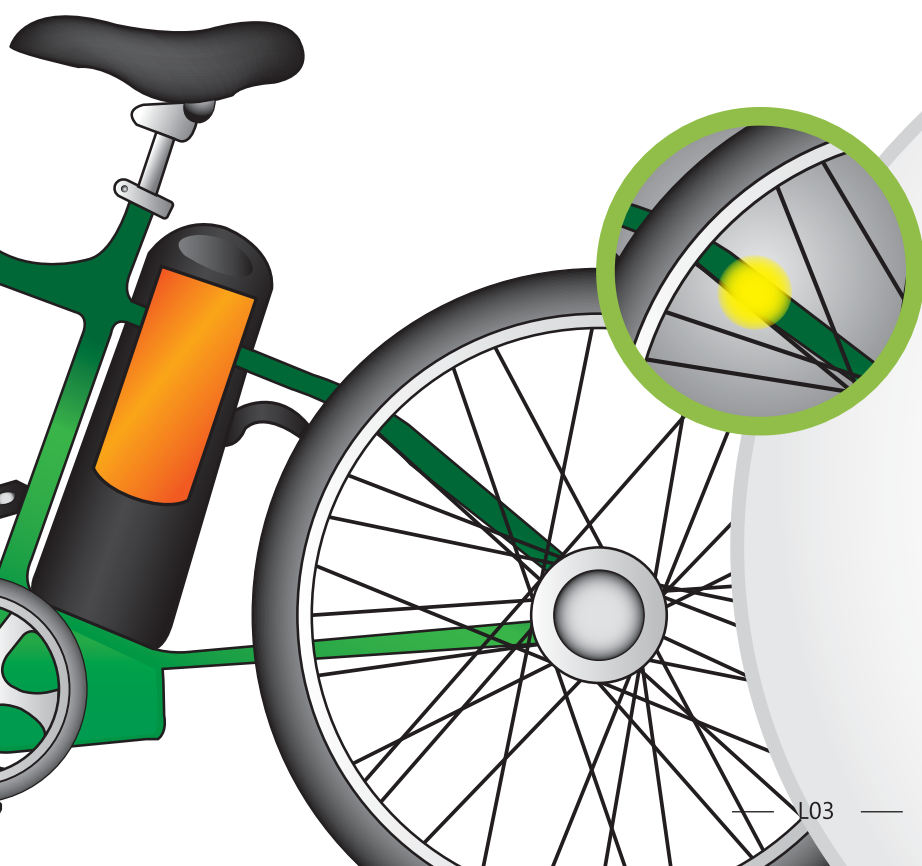

# Motor



**25A: 2 pins**  
2BA1014, 2BA1015



**20A+2A: 3+7 pins**  
2EB3004, 2EB3024



# LEV (e-bike) Connectors

IP65 • IP66 • IP67

For Battery Charger, Indicator, Controller, and Motor

## Indicator • 1A : 4 pins

### M5 Series, Molded with Cable

2MN3010-X04200  
Female Connector + Female pin

2MN3012-X04200  
Male Connector + Male pin



Cable OD : Max Ø3.5 mm  
Cable Length : Standard 1000mm ( L: customized )

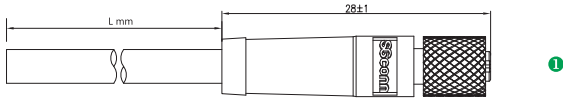

1A: 4 Pins

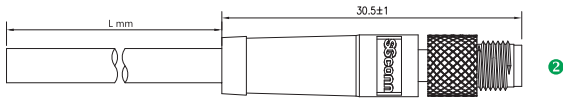

1A: 4 Pins

## Indicator • 2A : 8 pins; 5A : 3/4/5 pins

### M12 Series, Molded with Cable

2MT3010-X082XX, X0X3XX  
Female Connector + Female pin

2MT3012-X082XX, X0X3XX  
Male Connector + Male pin



Cable OD : Max Ø7.0 mm  
Cable Length : Standard 1000mm ( L: customized )

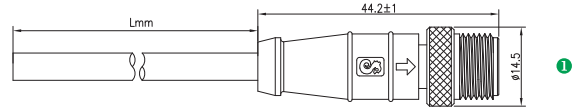

2A: 8 Pins



5A: 3 Pins



5A: 4 Pins



5A: 5 Pins

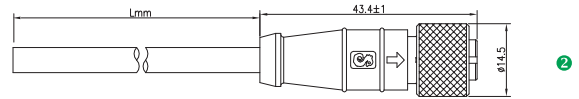

2A: 8 Pins



5A: 3 Pins



5A: 4 Pins



5A: 5 Pins

## Controller • 10A+2A : 3+3 pins

Molded with Cable

2EB3004-X069XX  
Female Connector + Female pin

2EB3024-X069XX  
Male Connector + Male pin



1



2

Cable OD : 1 Max Ø6.2mm; 2 Max Ø5.6mm  
Cable Length : Standard 1000mm ( L: customized )

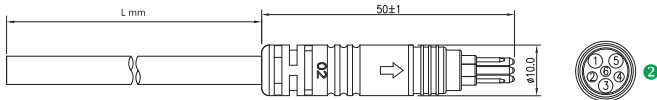
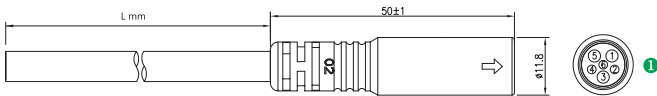

## Controller • 10A+5A : 3+6 pins

Molded with Cable

2EB3004-X097XX  
Female Connector + Female pin

2EB3024-X097XX  
Male Connector + Male pin



1



2

Cable OD : 1 Max Ø6.6mm; 2 Max Ø5.9mm  
Cable Length : Standard 1000mm ( L: customized )

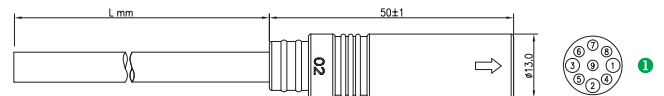

## Controller • 15A : 3 pins

Molded with Cable

2EB3004-X034AX  
Female Connector + Female pin

2EB3024-X034AX  
Male Connector + Male pin



1



2

Cable OD : Max Ø5.6mm  
Cable Length : Standard 1000mm ( L: customized )

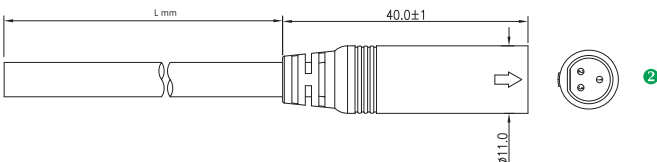
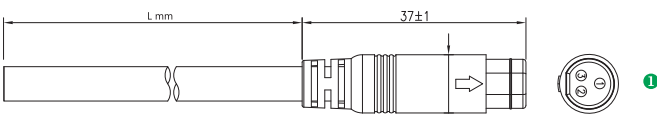

## Controller • 15A+2A : 2+11 pins

Molded with Cable

2EB3005-X13BXX  
Female Connector + Female pin

2EB3025-X13BXX  
Male Connector + Male pin



1



2

Cable OD : 1 Max Ø5.0mm; 2 Max Ø7.5mm  
Cable Length : Standard 1000mm ( L: customized )

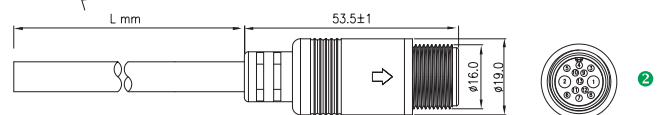
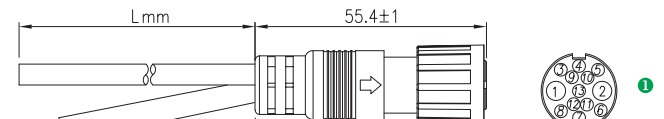



### Battery • 60A+5A : 2+7 pins

#### Discharger/ Frameset

2BA1010-0032XX  
Female Connector + Female pin

2BA1011-0042XX  
Male Connector + Male pin

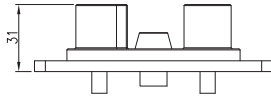
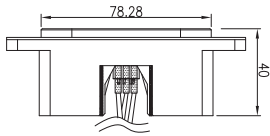
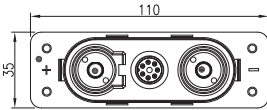
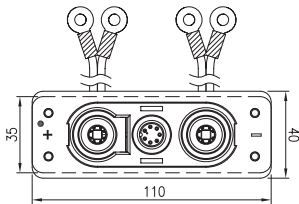

### Battery • 40A

#### Discharger/ Frameset

2BA1020-0002XX  
Female Connector

2BA1021-0002XX  
Male Connector

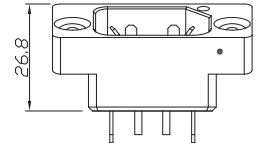
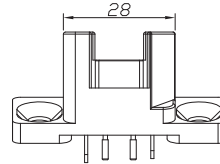
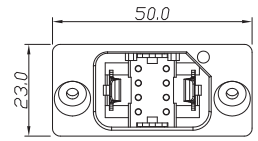
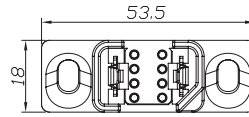

### Battery • 30A

#### Discharger/ Frameset

2BA1018-0002XX  
Female Connector

2BA1019-0002XX  
Male Connector

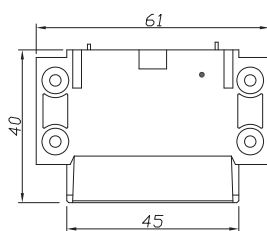
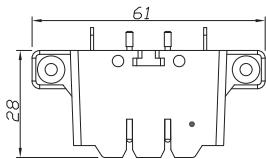
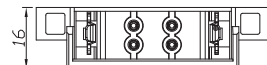

### Battery • 20A+5A : 2+8 pins

#### Discharger/ Frameset

2BA1031-V018XX  
Female Connector

2BA1032-V08FXX  
Male Connector

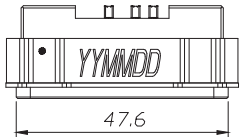
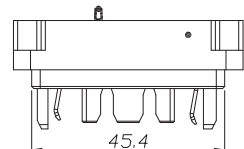
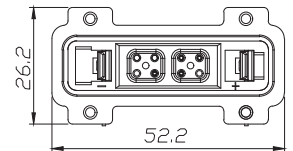
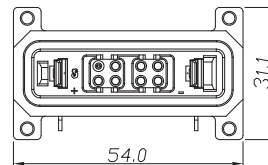



## Battery • 20A+5A : 2+3 pins

### Discharger/ Frameset (Solder Type)

2DS3002-X05FXX  
Female Connector + Female pin

2DS3012-X05FXX  
Male Connector + Male pin

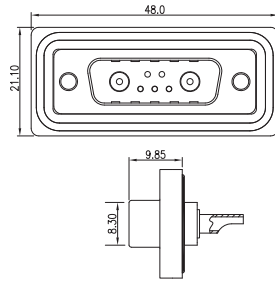
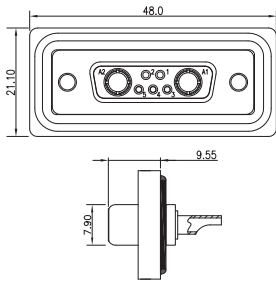

## Battery • 10A+5A : 2+2 pins

### Charger (Molded with Cable/ Panel Mount Solder Connector)

2CT3016-X048XX  
Female Connector + Male pin

2CT3020-X048XX  
Male Connector + Female pin



1

2

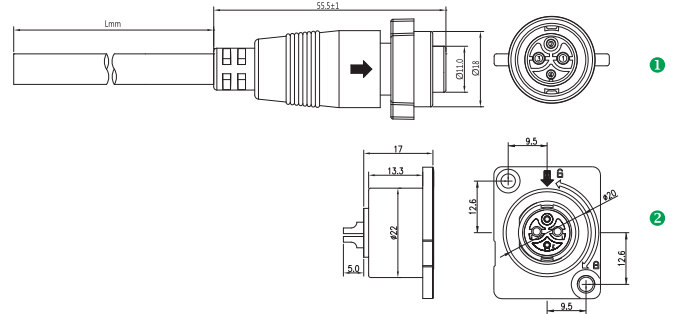

10A+5A: 2+2 Pins

## Battery • 10A : 3 pins

### Charger (Molded with Cable/ Panel Mount Solder Connector)

23016-X0340X  
Female Connector + Male pin

2CT3020-X034XX  
Male Connector + Female pin



1

2

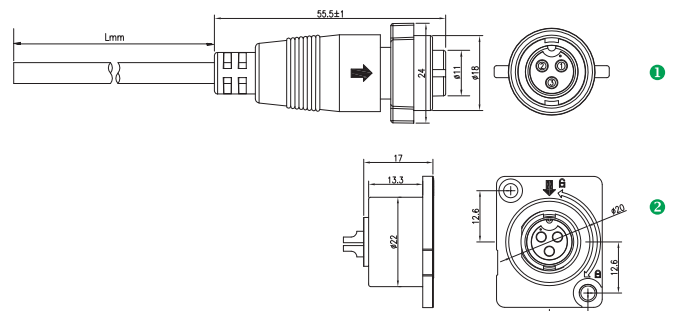

10A: 3 Pins



Please contact us for more information for your e-bike solutions.