

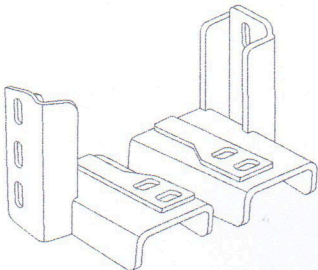

<p>①</p>  <p>Bracket, 1Set R,L</p>	<p>②</p>  <p>Bracket, 2Pcs.</p>	<p>③</p>  <p>Spacer, 1Pc.</p>
<p>④</p>  <p>Bracket, 1Pc.</p>	<p>⑤</p>  <p>Bolt M12 x 1.25 x 80, 4Pcs.</p>	<p>⑥</p>  <p>Bolt M12 x 1.25 x 50, 4Pcs.</p>
<p>⑦</p>  <p>Bolt M12 x 1.5 x 35, 6Pcs.</p>	<p>⑧</p>  <p>Spring Washer M12, 14Pcs.</p>	<p>⑨</p>  <p>Square Washer M12, 14Pcs.</p>
<p>⑩</p>  <p>Panel Bracket, 1Set R,L</p>	<p>⑪</p>  <p>Edging Rubber 30 CM, 2 Pcs</p>	<p>⑫</p>  <p>Edging Rubber 55 CM, 2 Pcs</p>

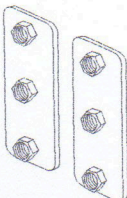

Part#  
B W 8 0 - 4 1 2 1

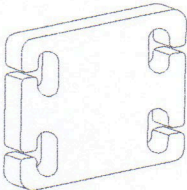
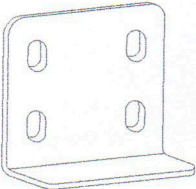
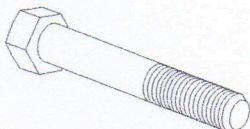
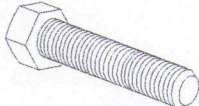
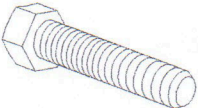

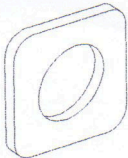
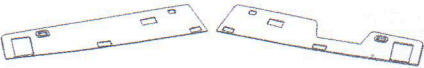
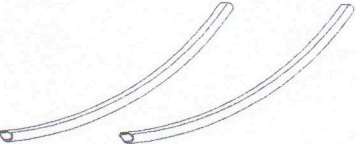
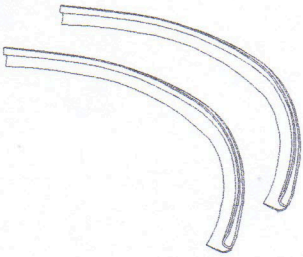
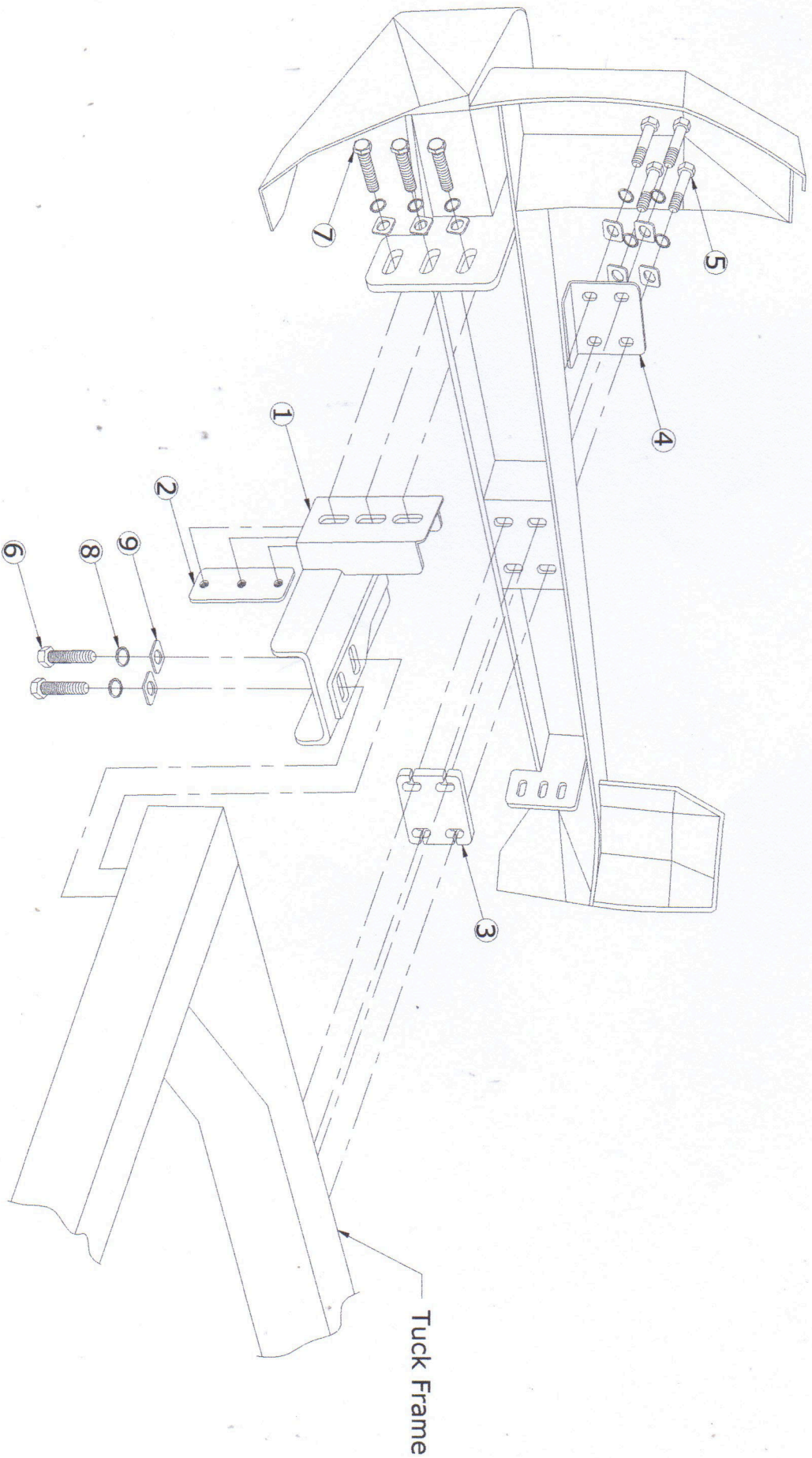
## FITTING PROCEDURE



- Take off a rear plastic bumper.

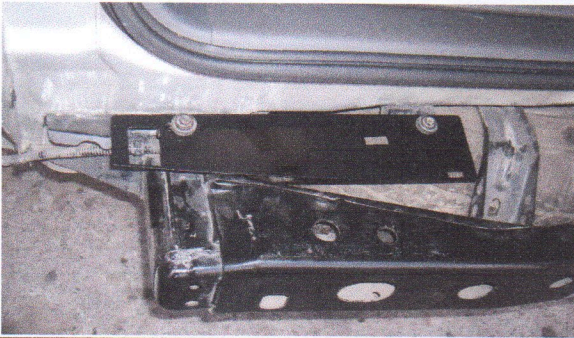

- Installed a left panel bracket.(No.10)



- Installed a right panel bracket.(No.10)



- After fitted the plastic cover body's brackets.



- Refitted a plastic body cover.

## FITTING PROCEDURE



- Refitted the holder of back door.

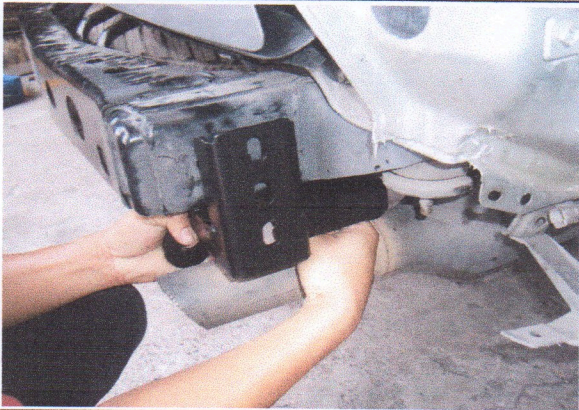

- Installation the left & right brackets.

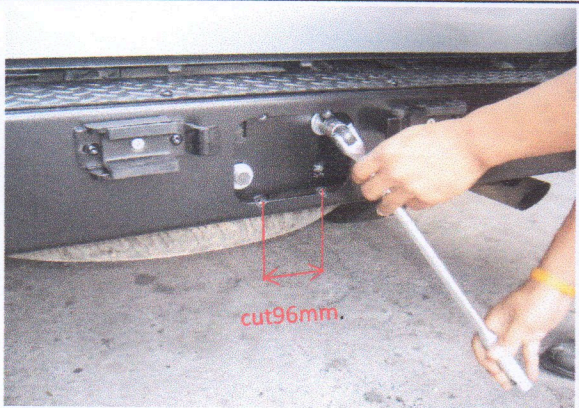

- Installed a rear bar.



- After fitted a middle mounting.

## FITTING PROCEDURE



- Put the bearing on axles.

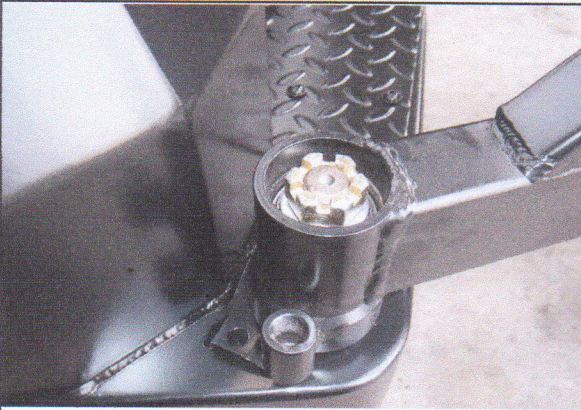

- After installation the swing arms.



- Cover rubber for end the bar.



Complete installed on Prado 120