

# Bullbar Installation Guide

Part Number: BU59-3506 & BU59-3656

Fits:



## Toyota Landcruiser 76,78,79 Series V8



***This Bullbar will take approximately 2.5 hours to install***

Tools required are

- Spanners and socket set.
- Pneumatic hacksaw.
- Screwdrivers
- Pliers and side cutters

***Dobinsons BULLBARS should be installed by a qualified installer and it is the installer responsibility to ensure correct fitment.***

*Fully read and understand the instructions before beginning the installation*



**Part#**  
**BU59-3656**

**Fitting Instructions 2 of 2**

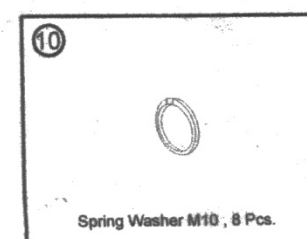
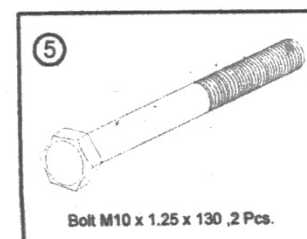
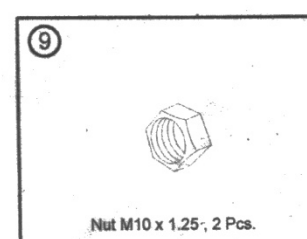
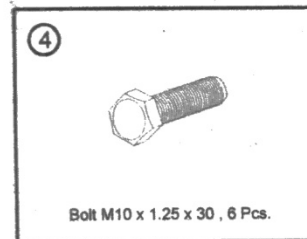
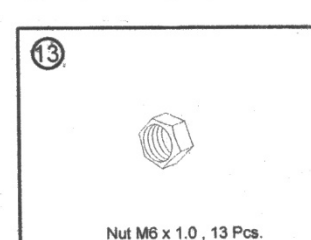
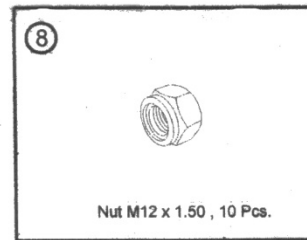
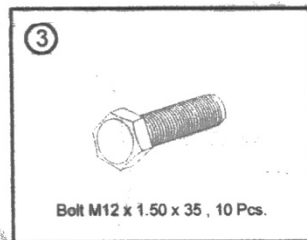
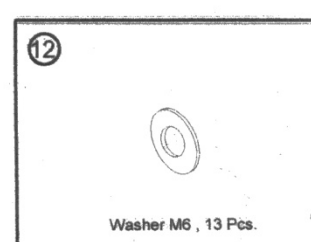
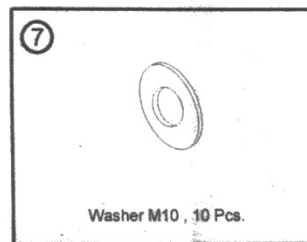
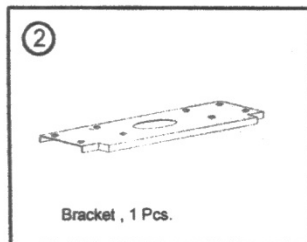
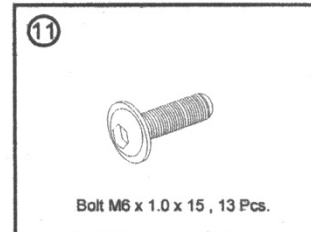
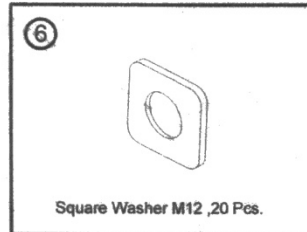
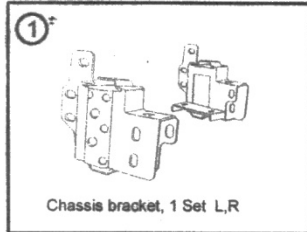



**Part#**  
**BU59-3656**  
**Fitting Instructions**

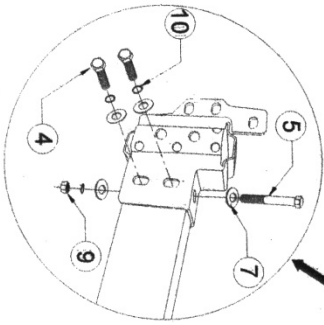
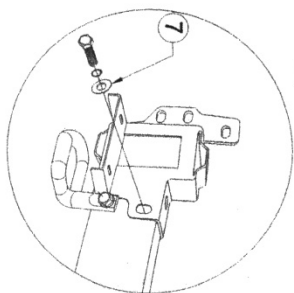
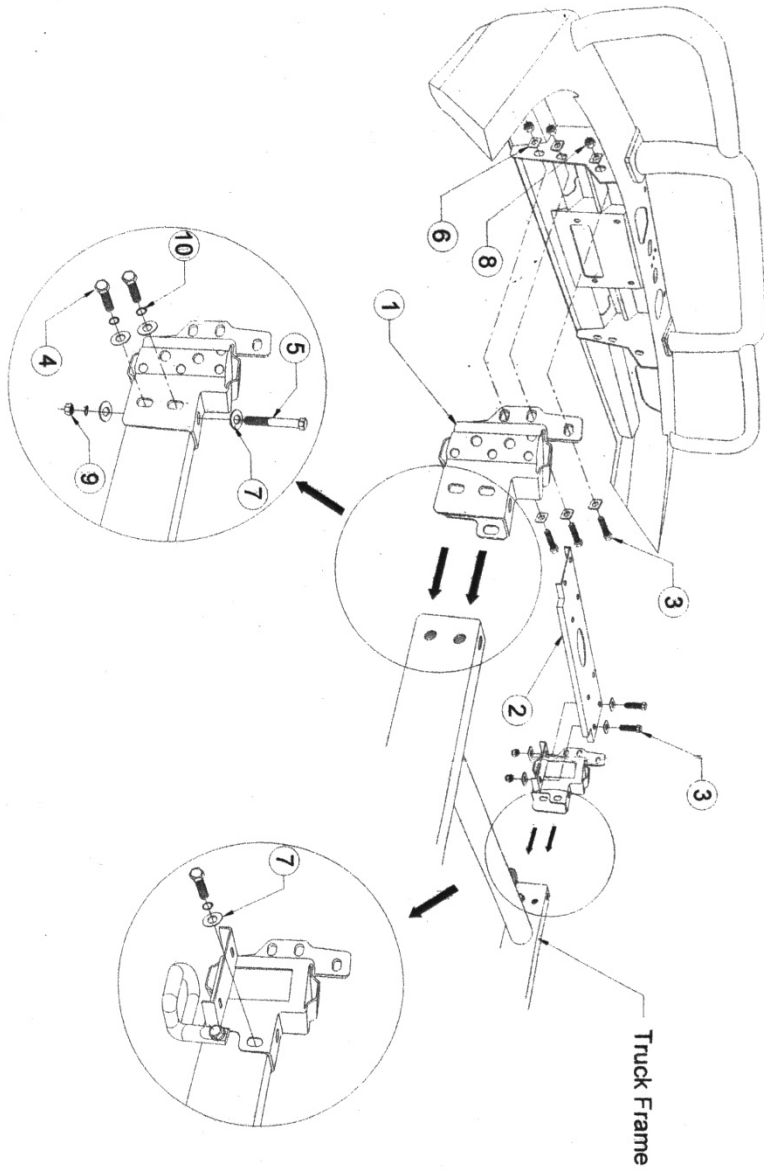

**OPTION**

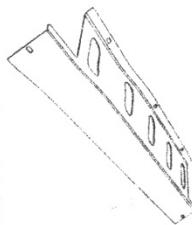

Middle under protection plate , 1 Pos.



RHS under protection plate , 1 Pos.  
 LHS under protection plate , 1 Pos.

## Fitting Guide

1. Remove the number plate.
2. Remove the bumper bar and bumper reinforcement or factory bullbar if fitted.
3. Install the bullbar mounting bracket and winch mounting frame as per the diagram on page 3. Ensure the outer bullbar brackets (item 1) are spread as wide as possible and then tighten all bolts.
4. Carefully un-wrap the bulbar taking care not to scratch it especially on the top loops. Reinstall the number plate. If installing driving lights to the bullbar it is easiest to install now.
5. If not installing a winch skip to step 13.
6. See the Installation section of your Dobinsons 4x4 Winch manual for specific detailed fitting instructions. For a brief overview see the following steps.
7. Test fit your winch to the mounting bracket and do up loosely with the clutch handle on the left hand side of the vehicle.
8. This may require the clutch handle and gearbox housing to be rotated forward one or 2 bolt holes to allow easy access through the bulbar holes. See instructions in winch user manual.
9. Determine where the winch control box will be located and mount the control box. See instructions in winch user manual for control box mounting options. If mounting to the top of the bullbar using the supplied bracket, check clearance of control box to grill and also check where the wires will route as if the wires are passing through the holes in the top of the bullbar the control box may not be able to be wired until the bullbar has been fitted as below.
10. Wire the winch up as per the winch instruction manual and bolt the winch to the mounting bracket, ensure the mounting bolts are not too long and tighten correctly. Route the wires and connect to battery and also route the breather hose.
11. Unwind some cable from the winch, and pass the cable through the fairlead hole in the bullbar and through the roller fairlead. This may require removing a circlip from the fairlead and re installing once the cable is passed through.
12. Install the roller fairlead into the bulbar.
13. Check the poly bulbar over riders, fog light and top loop bolts are tight (Do not over tighten the stainless steel loop mounting bolts. Do not over tighten the poly bullbar over riders as they will pull the over riders out of shape).
14. Wire up the lights. Using a multimeter or test light first locate the earth wire, parker positive and indicator positive wires from the wiring on the back of the original vehicle lights on each side.
15. Unclip the wiring from the indicator/parker lights. Check that the wiring will be long enough to reach the new bullbar indicator/parker lights and extend if required. Using the diagram at the end of this manual, join the corresponding wires to original vehicle wires located in the previous step. The wires can be joined by either using good quality snap lock crimp connectors or by soldering. Ensure the connection is secure and is sufficiently insulated.
16. If fitting a bullbar with fog lights, the fog lights can be connected using the original vehicle fog light wires if fitted. If required, cut the old fog light wiring plugs off and cut the new fog light wiring plugs and join. If the vehicle is not fitted with OEM fog lights the wiring loom supplied can be used. Follow the wiring diagram at the end of this manual.
17. With help, fit the bulbar into position and install nuts and bolts supplied.
18. Align the bar with the vehicle into its correct position.



19. Once you are happy with the alignment tighten the nuts and bolts on each side.
20. Once happy with the alignment of the bullbar drill 2 x 8mm pinning holes on each side of the bullbar drilling through both the mounting bracket mounting plate and bullbar mounting plate. Fix with 8mm bolts and nyloc nuts to keep the bullbar in its position. This can be easier done with a small drill from the inside of the bar.



21. Plug the wires into the indicator, parker light plug and fog lights. Test all lights and adjust the position of the fog lights if required.
22. Fit the under bar protection kit now with the bolts supplied. Check over all items removed during installation.
23. Trim the wheel arch mud guard liners back so they are not visible from the front of the vehicle and secure.
24. **IMPORTANT NOTES:** It is important to inform the customer that headlight adjustment may also be required due to the change in ride height. It is also important to inform the customer that there will be a change in vehicle handling characteristics. It is also important to note that due to their nature fog lights are required to provide a yellow light to



allow clear fog vision. For this reason Dobinsons bullbars utilise a Halogen bulb. Halogen bulbs generate a considerable amount of heat to achieve the yellow colour and this causes the air inside the fog light lens to expand and contract. For this reason the fog light assembly cannot be sealed and has a small breather on the back. In some cases this may cause condensation to form inside the fog light. The customer may choose to seal the lens of the fog light but must not seal the rear breather.

# FOG LIGHT WIRING DIAGRAM

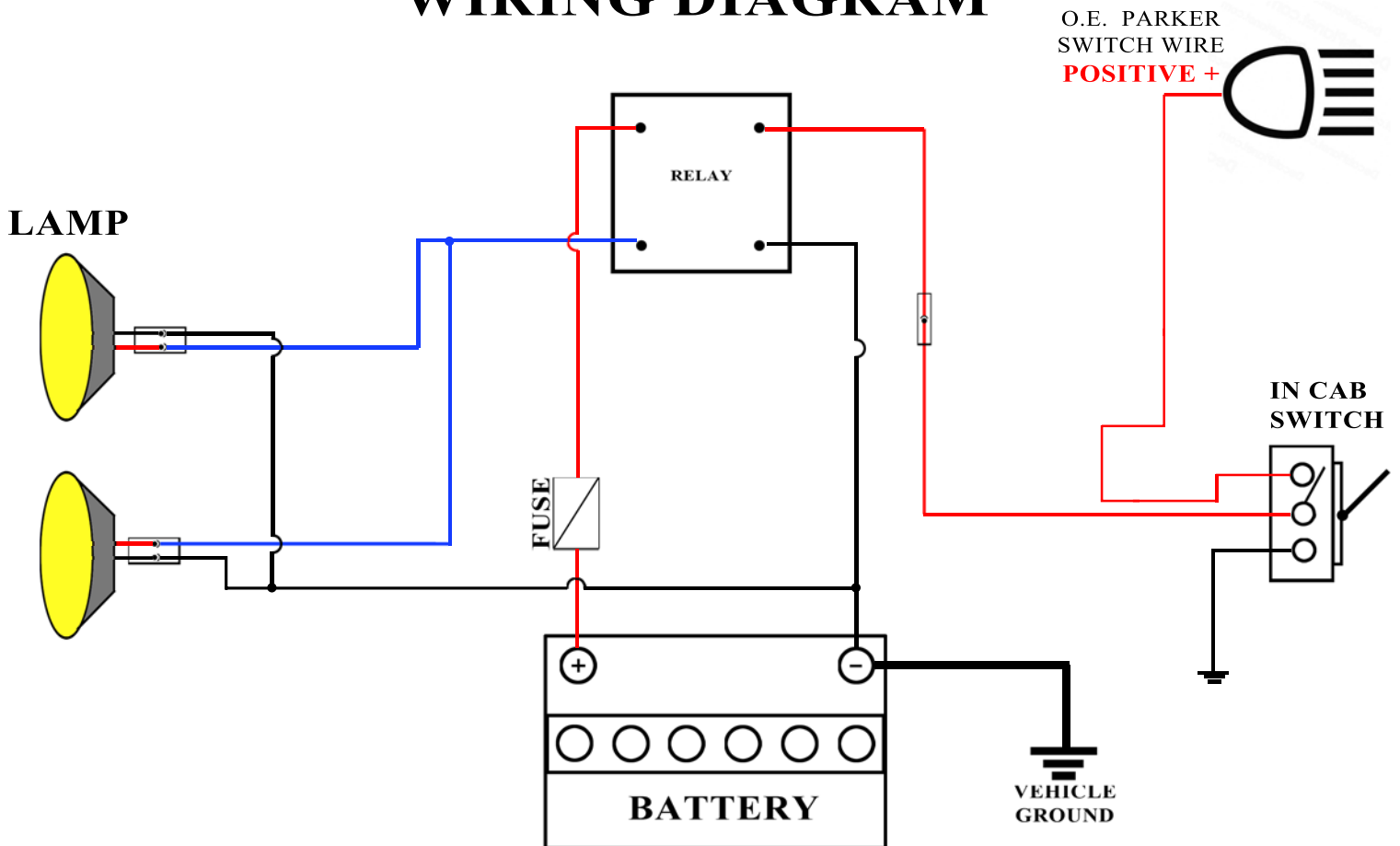

**CHECK THE PARKER/INDICATOR WIRING LIGHT CONFIGURATION AND USE THE CORRECT WIRING DIAGRAM AS SEEN BELOW**

**TYPE 1 - YELLOW, BLACK WHITE FROM LIGHT AND CONNECTOR**

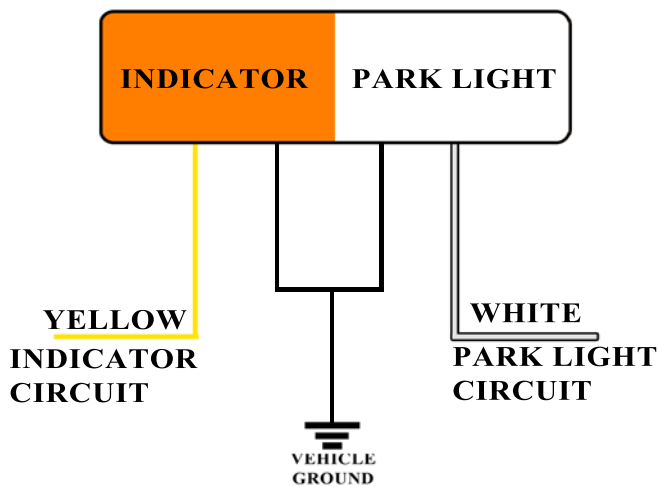

**TYPE 2 - YELLOW, WHITE, BROWN FROM LIGHT BLACK, WHITE, RED FROM CONNECTOR**

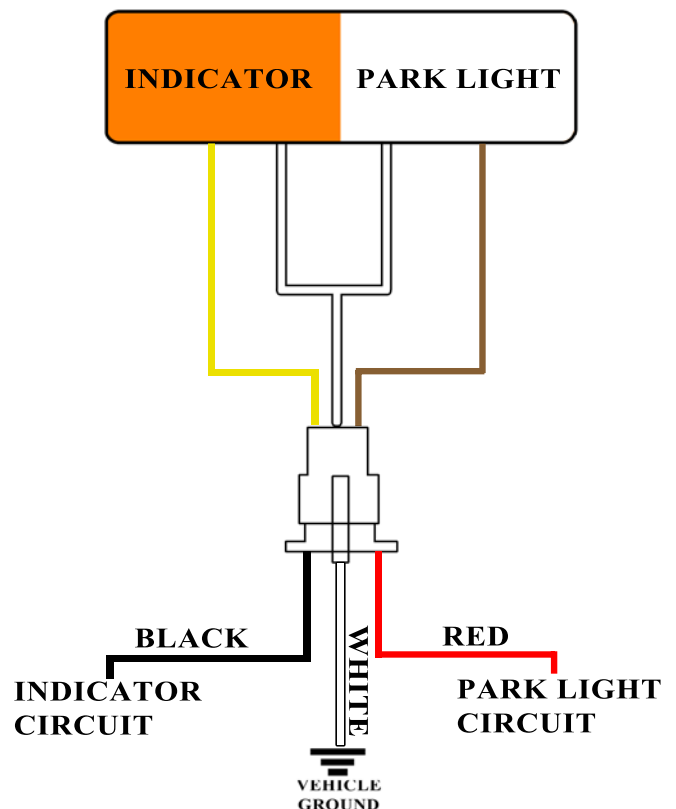

## Customer Copy: Bullbar Care Instructions



To ensure the surface finish quality it is recommended that the bullbar be washed and cleaned regularly to prevent build up of dirt and contaminants which when exposed to the elements can degrade the surface finish. It is also recommended that the mounting fasteners on the bullbar be checked after 1000km's. Winch servicing and care should also be carried out as per the winch instruction manual.

### **Stainless Loop Deluxe Bullbar Loop Care and Maintenance**

*(Customers with Stainless Loop Deluxe Models Only)*

The top loops on your Dobinsons Stainless Loop Deluxe steel bullbar are manufactured from high quality 304 grade stainless steel. Once formed and welded it is highly polished to provide a high gloss finish. Whilst the material is a high quality stainless steel, like any other exterior polished surface, care and some maintenance is required to ensure the surface finish quality.

It is recommended that the stainless loops be kept as clean as possible and is thoroughly washed and dried regularly to prevent build up of dust and contaminants. This is especially important in coastal and high dust areas. The loops can simply be cleaned with most regular car cleaning items like a soft sponge, car wash and a chamois, avoid strong cleaning chemicals. Like many other highly polished exterior metals, over extended periods of time and heavy weathering can cause some staining of the surface may occur. If this occurs the surface can be simply polished using the following methods to remove the stains and restore the high gloss surface using simple tools and cheap readily available polishing items.

Tools Required:

- Electric buffer or Electric drill (an electric/cordless drill is generally more convenient).
- Polishing compound – This can be supplied by Dobinsons Spring and Suspension. Please contact head office on the details below for polish, as a specific type is used.
- Soft finishing type buffing wheel – The buffing wheel should be a soft, finishing type/Calico loose leaf style to allow the surface to be polished to a high gloss without further marking the surface. The 2 types of discs shown below are readily available from most hardware stores (Australian customers – Bunnings etc). The brand below is Josco, and if purchasing a twin pack ensure that only the finishing buff is used and not the cutting buff. **DO NOT USE METAL OR HARSH BUFFING PADS.**



## Method

1. The stainless loops may be removed from the bullbar if this makes it easier to work on, however if using a cordless drill this is not a necessity. If removing the loops, do not over tighten the loop retaining bolts when re fitting.
2. Ensure the loops are first completely clean and dry.
3. Fit the polishing buff wheel to the drill or buffing tool –take note of the maximum wheel speed and rotation direction.
4. It is recommended to follow specific instructions on the packaging of the buffing wheel for best results. However if no instructions are provided the following guidelines can be used:
  - A). Carefully dress the buff wheel with the compound across the rotating wheel for a few seconds, taking care not to apply too much compound, it is better to apply a little compound more frequently than to overdress the buff.



- B). Gently buff the work area with the buffing wheel and with light pressure move back and forth across the job.



- C). After polishing use a soft, clean, dry rag to clean the surface and inspect in the light for an even finish.
- D). Once complete clean thoroughly again with a sponge and warm water.