



ACTIVITY CENTER

Assembly Instructions

BASE D'ACTIVITES

Instructions d'assemblage

BASE DE ACTIVIDADES

Instrucciones de Ensamblaje

AKTIVITÄTENSATZ

Aufbauanleitung

BASE DE ATIVIDADES

Instruções de Montagem

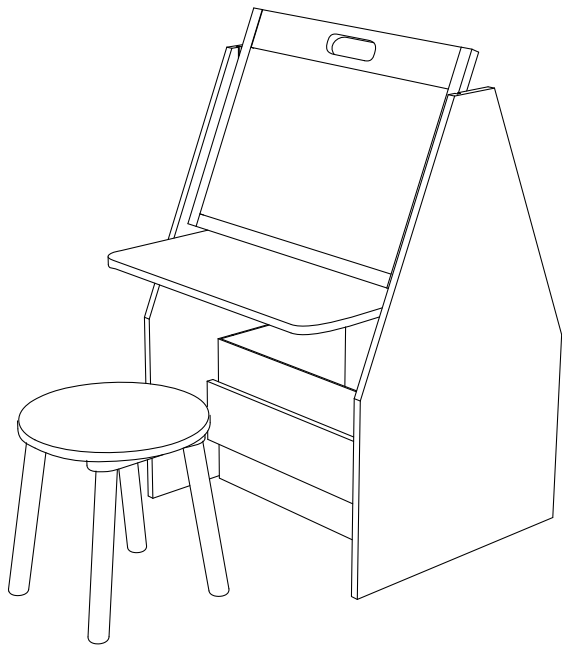

KEEP INSTRUCTIONS FOR FUTURE USE.

▲ WARNING:

SMALL PARTS: NOT SUITABLE FOR USE BY CHILDREN UNDER 36 MONTHS. THIS ITEM REQUIRES ASSEMBLY BY AN ADULT BECAUSE OF SMALL PARTS. CARE SHOULD BE TAKEN IN UNPACKING AND ASSEMBLY OF THIS PRODUCT.

CONSERVEZ LES INSTRUCTIONS POUR UN USAGE ULTERIEUR.

▲ ATTENTION:

PETITES PIÈCES: NON CONVENABLE POUR ENFANTS DE MOINS DE 36 MOIS. CET ARTICLE NÉCESSITE ÊTRE ASSEMBLÉ PAR UN ADULTE EN RAISON DE LA PRÉSENCE DE PETITES PIÈCES. IL FAUT FAIRE ATTENTION LORS DU DÉBALLAGE ET DE L'ASSEMBLAGE DE CE PRODUIT.

MANTENGA LAS INSTRUCCIONES PARA SU USO FUTURO.

▲ ADVERTENCIA:

PIEZAS PEQUEÑAS: NO APROPIADO PARA NIÑOS MENORES DE 36 MESES. ESTE ARTÍCULO REQUIERE ENSAMBLAJE POR UN ADULTO DEBIDO A PIEZAS PEQUEÑAS. SE DEBE TOMAR CUIDADO EN EL DESEMPAQUE Y EL ENSAMBLAJE DE ESTE PRODUCTO.

BEWAHREN SIE DIE INSTRUKTIONEN FÜR SPÄTERE BENUTZUNG AUF.

▲ WARNUNG:

KLEINE TEILE: NICHT GEEIGNET FÜR KINDER UNTER 36 MONATE. DÜRFEN NUR VON ERWACHSENEN ZUSAMMEN GEBAUT WERDEN. ACHTEN SIE BEIM AUSPACKEN UND ZUSAMMENBAUEN AUF DIE KLEINEN ELEMENTE.

MANTENHA AS INSTRUÇÕES PARA SEU USO FUTURO.

▲ AVISO:

PEÇAS PEQUENAS: NÃO É ADEQUADO PARA USO POR CRIANÇAS MENORES DE 36 MESES. ESSE ITEM PRECISA SER MONTADO POR UN ADULTO DEVIDO AS PEÇAS PEQUENAS QUE CONTÊM. PRECISA UTILIZAR O MÁXIMO DE CUIDADO PARA ABRIR E MONTAR ESTE PRODUCTO.

Consumer Care:

www.DeltaChildren.com
Delta Children's Products
114 West 26th Street
New York, NY 10001
Tele.212-645-9033

When contacting Delta Consumer Care, please reference the information on the Product Information label found on the product.

Lorsque vous contactez le Service après Vente de Delta, veuillez nous donner les références sur l'étiquette d'Information qui se trouve sur le produit.

Cuando contacte al Servicio de Atención al Consumidor de Delta por favor mencione los datos que aparecen en la etiqueta de información que se encuentra en el producto.

Wenn Sie den Kundenservice von Delta kontaktieren, beziehen Sie sich bitte auf die Information auf der Etikette des Produktes.

Ao entrar em contato com o Atendimento ao Consumidor da Delta, por favor mencione as informações encontradas na etiqueta de informações do produto.

Parts, Pièces, Piezas, Teile, Peças

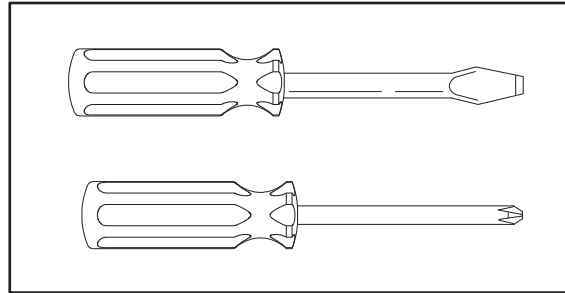
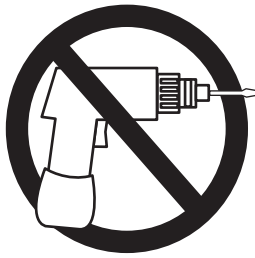

1 x
A

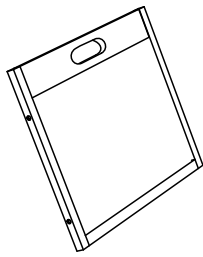

1 x
B

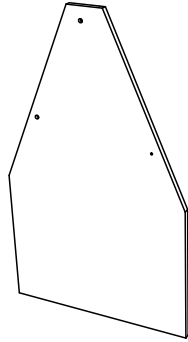

1 x
C

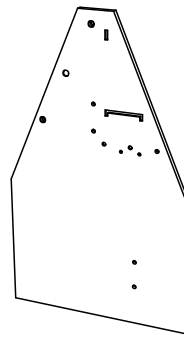

1 x
D

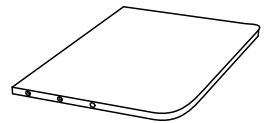

2 x
E

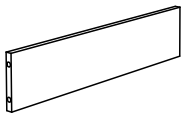

2 x
F



1 x
G



4 x
H



2 x
I



1 x
J



1 x
K

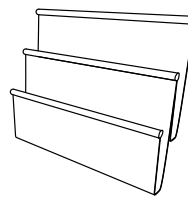

1 x
L

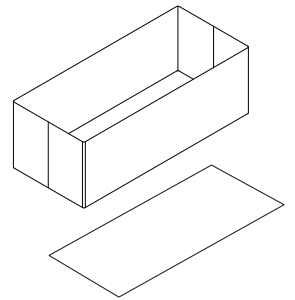

2 x
AA



4 x
BB



4 x
CC



2 x
DD

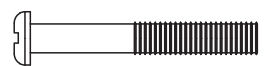

6 x
EE

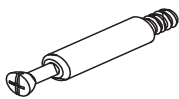

6 x
FF



4 x
GG

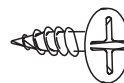

4 x
HH



1

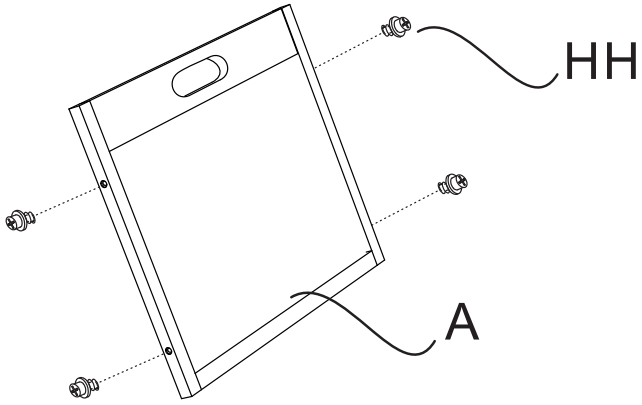

2

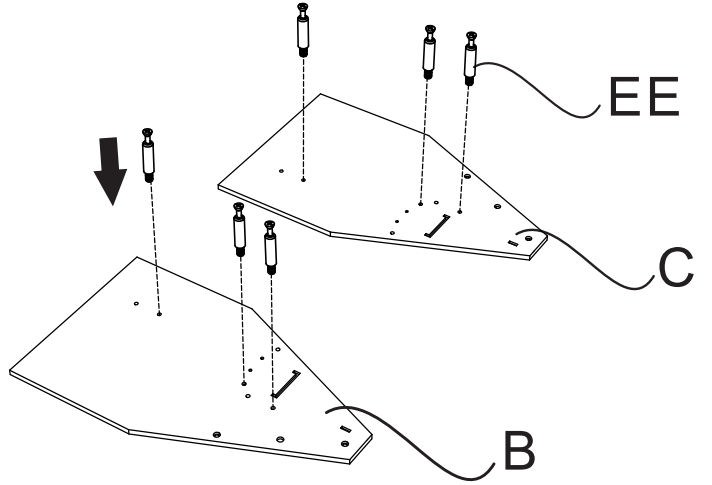
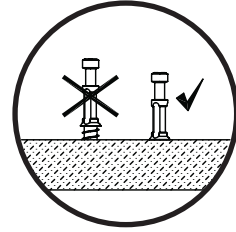

3

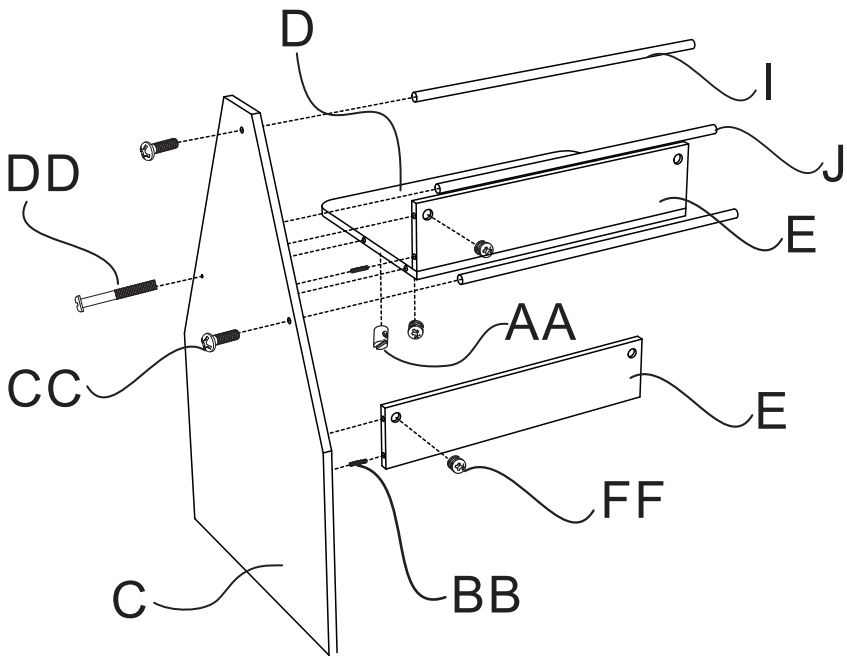

4

