



ASSISTED AUTO CLOSE

GATE "WHITE"

#089346-003



743mm - 940mm

749mm

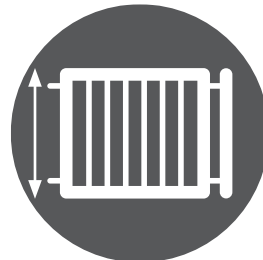

**IMPORTANT:
RETAIN FOR FUTURE REFERENCE,
READ CAREFULLY**

PLEASE NOTE - IMPORTANT NOTICE



Please keep in mind, when removing gate from carton that the gate may seem visually distorted or faulty; **THIS IS NOT THE CASE.**

The gate is designed in this shape in order to ensure that when the top **ADJUSTERS** are correctly adjusted, the **GATE FRAME** is straightened ensuring the correct pressure is achieved.

GATE WHEN REMOVED FROM CARTON

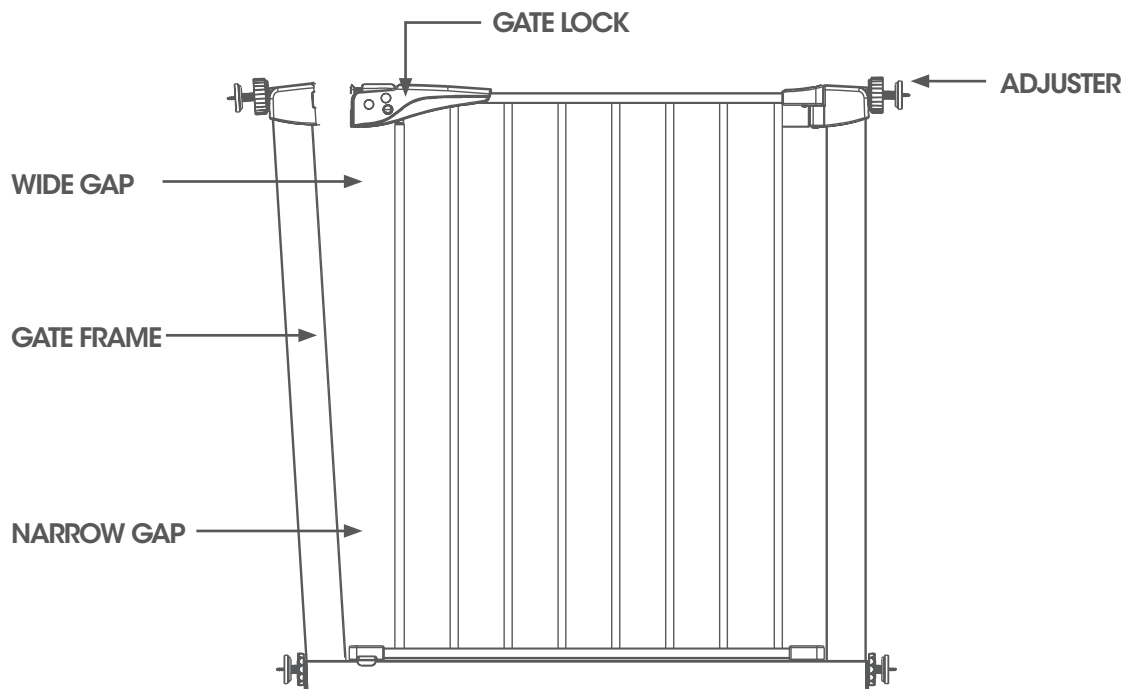

GATE STRAIGHTENED WHEN INSTALLED TO THE WALL

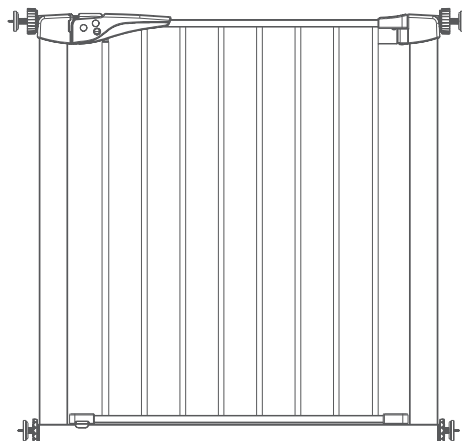

This gate is designed for children from 6 months to 24 months. Since each child's skills develop at different ages, these parameters should be monitored against your child's own development.

Read all instructions before assembly and use of the safety gate. Keep instructions for future use.

⚠ WARNING ⚠

- Intended for use with children from 6 months through 24 months.
- Check the stability of the gate and tighten all hardware and mountings regularly.
- To prevent serious injury or death, securely install gate or enclosure and use according to manufacturer's instructions.
- Install according to the manufacturer's instructions.
- NEVER use with a child able to climb over or dislodge/open the gate or enclosure.
- NEVER use if gate is less than 3/4 of child's height.
- DO NOT use if any part of the gate is broken or missing.
- This product will not necessarily prevent all accidents. Never leave child unattended.
- Use only spare parts available from cnp brands.
- NEVER allow child to climb or swing on gate.
- Use only with the locking/latching mechanism securely engaged.
- NEVER use gate at top of stairs.
- Discontinue use if any part of the gate is damaged.
- NEVER climb over the gate.
- NEVER hang or tie toys, etc, to any part of the gate.
- NEVER use to keep child away from pool.

Gate Opening Size:

- 743mm - 800mm (no extension)
- 810mm - 870mm (with 1 extension)
- 880mm - 940mm (with 2 extensions)

Congratulations on your purchase of the **Assisted Auto Close Gate "White"**

This product has been designed and developed with safety, comfort and functionality in mind. Please take the time to read this manual carefully before using this product and keep it in a safe place for future reference.

Contents

Assembly contents list

Assembly / Operating instructions

How to care for your **Assisted Auto Close Gate**







Due to variations in the style and design of our products, the photographs and illustrations shown in this instruction manual are generic, therefore product fabrics, colour and design may vary from images shown. CNP Brands reserves the right to alter product specifications without notice as a result of our ongoing policy of product improvement.

Check what you have received...

You have received **1 box**. Please check the contents of the box against the list below. If anything is missing, please contact Customer Service.

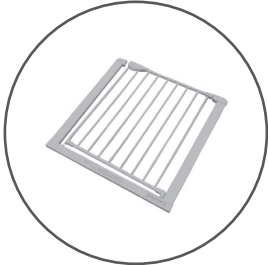
In Australia, contact **CNP Brands on 1300 667 137**, in New Zealand contact **Wainhouse Distribution on 0800 567 5000**.

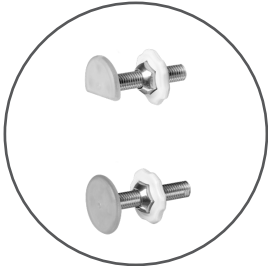
Supplied loose in box:

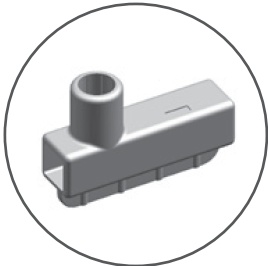
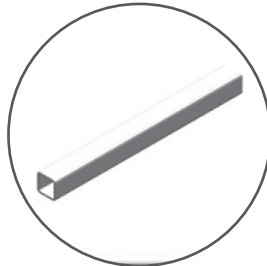
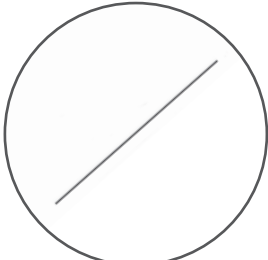
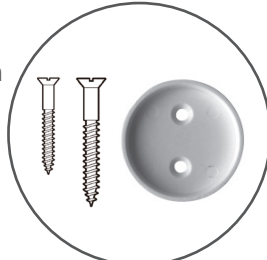
Gate Section		x 1	Spindle Housing		x 4
Bottom Spindle		x 2	Upper Extension Housing		x 2
Top Spindle		x 2			
Lower Extension Housing		x 2	Extension Tube		x 4
Extension Bar		x 2	Short Screw 20mm		x 4
			Long Screw 35mm		x 4
			Top Spindle		x 2
			Plastic Protector		

Recommended for use with the Childcare Assisted Auto Close Gate Extension (sold separately).

To install Safety Gate...

1

- 1a. The gate must be installed in a structurally sound opening.
- 1b. Never install between two railings or two stair posts. Ensure mounting surface (wall, door frame, etc) is strong, rigid and is smooth, clean and grease free.
- 1c. If mounting onto brick, plaster board or other surfaces, an optional gate installation kit, wooden board mounted to the surface or additional hardware may be necessary to provide a solid, smooth surface.

2

- 2a. Measure opening to determine if extensions are needed.
- 2b. Correct width will be reached by adjusting all 4 corner spindles.
- 2c. Each spindle adjusts individually and may be extended to varying lengths (up to 45mm) to allow for moulding, uneven walls etc.
- 2d. This gate can be used in a closed doorway. Never use gate at the top of the stairs.



To install Safety Gate (continued)...

- 3**
- 3a. Spindle attachment is different when using extensions and when not using extensions.
- 3b. Spindle housings are not used if square extension tubes are required, If the housings have been inserted, remove with a screwdriver.

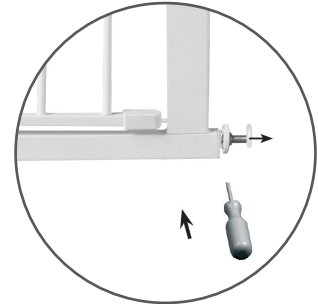

- 4**
- 4a. If no extension/s are used, slide top spindles (A) and bottom spindles (C) into spindle housing end (B).
- 4b. Push assembly into gate corners.

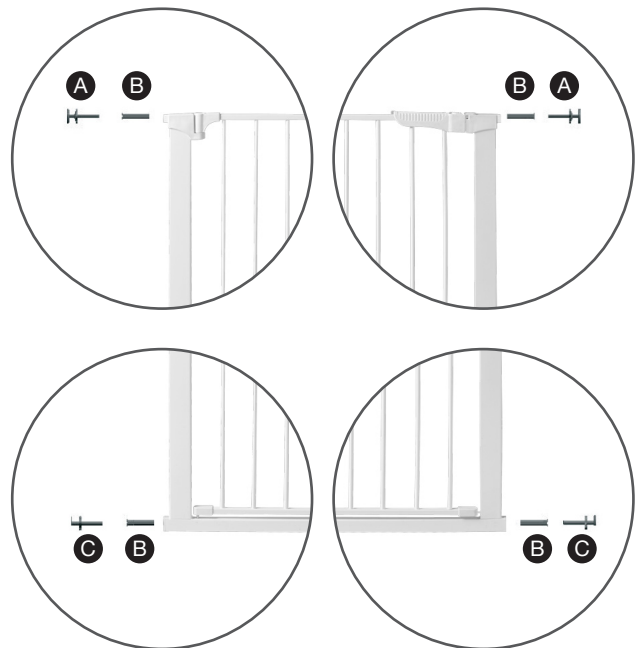

- 5**
- 5a. If using extension/s, insert square extension tubes (f) into gate ends.
- 5b. Connect extension bar (g) to one upper extension housing (d) and one lower extension housing (e).
- 5c. Push assembly over extension tubes.
- 5d. There should be no metal showing from extension tubes.
- 5e. It may be necessary to apply pressure to tubes to ensure they are fully inserted into gate ends.
- 5f. Slide top spindles (a) and bottom spindles (c) into extension tubes.

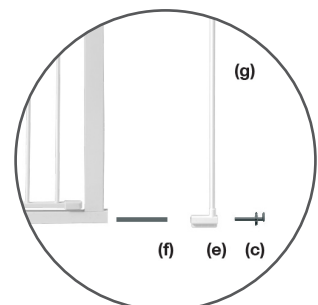
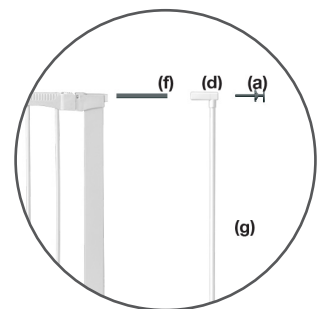

To install Safety Gate (continued)...

- 6**
- 6a. Screw a top spindle plastic protector onto top mounting surface at 74.5cm high to prevent top spindle from moving.
- 6b. Repeat for other side.

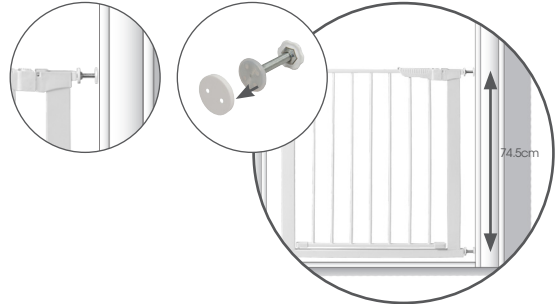

- 7**
- 7a. Centre the gate in opening with bottom rail resting on floor.
- 7b. Gaps on each side should be equal.



IMPORTANT: The gate must be level and straight up and down, otherwise the gate's self closing door will not function properly.

- 8**
- 8a. Pull out the two bottom spindles (c) until they touch the mounting surface and rest on top of floor moulding (if applicable).
- 8b. Tighten hand-wheels TOWARD GATE FRAME as tightly as possible.
- 8c. Each spindle adjusts individually and may be extended to varying lengths to allow for moulding, uneven walls, etc.

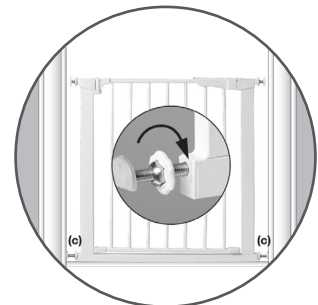

- 9**
- 9a. Close walk through door so it is aligned directly above bottom gate rail.
- 9b. Pull out top spindle (a) on the hinge side (h) until it touches mounting surface.
- 9c. Tighten hand-wheel TOWARD GATE FRAME.

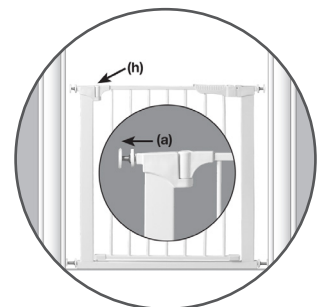

- 10**
- 10a. Pull out top spindle (a) on handle side until it touches mounting surface and tighten hand-wheel TOWARD GATE FRAME.
- 10b. Take turns tightening both top spindles until tension is reached and the distance between the handle and frame is 0.80mm.

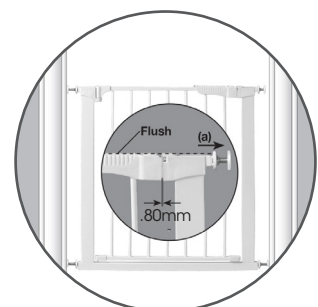

To install Safety Gate (continued)...

11

- 11a. To open gate: Pull back release button (i) on handle. Lift gate door and swing open.

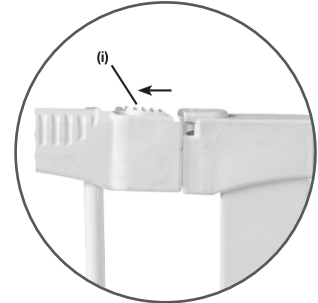

12

- 12a. To close gate: The walk through door will automatically close by itself and the lock will re-engage.

Test the gate door from both directions.

If the gate is lined up properly the door will close automatically, confirmed with an audible 'click'.

If it closes from one side and not the other, it means that the gate is tilted towards the side that it will NOT close from.

When this is the case, loosen the lower spindles and straighten the gate in the doorway; tighten the spindles and test again.

Continue to test until gate door automatically closes from both sides.

Now the gate is in proper working order.



To use the Hold Open Feature...

1

- 1a. By opening the door to a 90 degree or greater angle, it will stay open until it is pushed closed.

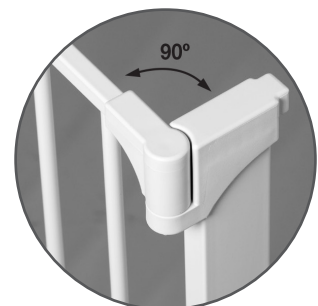



Cleaning

To ensure the long-lasting use of your gate, wipe down with a damp cloth and use a mild soap solution if necessary. Do not use abrasive cleaners. Always store product in a clean dry place.

Maintenance

Always check parts regularly for tightness of screws, nuts and other fasteners – tighten or replace if required. To maintain the safety of your safety gate, seek prompt repairs for bent, torn, worn or broken parts. Use only those parts and accessories approved by **CNP Brands**.

If you have any difficulties in assembling the safety gate, please contact our Service Department.

In Australia, contact **CNP Brands on 1300 667 137**, in New Zealand contact **Wainhouse Distribution on 0800 567 5000**.



CNP BRANDS

CHILDCARE NURSERY PRODUCTS | EST. 1899

About CNP Brands

Currently, **CNP Brands** boasts one of the most diverse brand portfolios with a combination of company owned brands and distribution agreements. These include distribution lines for **Evenflo, Good Baby, Lascal, Maclaren, Project Nursery, Summer Infant and Yookidoo.**

Our own brands, including **Childcare**, have gone from strength to strength in recent years. **Childcare**, and our premium brand **bebe care**, demonstrate our commitment to quality and continuing investment in product development.





CNP BRANDS

CHILDCARE NURSERY PRODUCTS | EST. 1899



Distributed in Australia by CNP Brands
82 Maribyrnong Street, Footscray, VIC, 3011
Customer Service 1300 667 137

W: www.cnpbrands.com.au
E: info@cnpbrands.com.au
F: www.facebook.com/CNPBrands
I: @cnp_baby

Distributed in New Zealand by Wainhouse
Distribution
2-6 Argyle St, Morningside,
PO Box 41-014,
St Lukes, Auckland, New Zealand
Customer Service: 0800 567 5000

E: helpline@wainhousedist.co.nz

