



Montana

Change Centre "White"
Model # 057663-003



**IMPORTANT:
RETAIN FOR FUTURE REFERENCE,
READ CAREFULLY**

Read all instructions before assembly and use of the change centre.
Keep instructions for future use.

⚠ WARNING ⚠

FOLLOW THE MANUFACTURER'S INSTRUCTIONS.
DO NOT LEAVE YOUR CHILD UNATTENDED.
CHILDREN HAVE DROWNED WHILE USING BATH AIDS.
THIS IS NOT A SAFETY DEVICE.
ALWAYS KEEP YOUR BABY WITHIN ARM'S REACH.
NEVER LEAVE YOUR BABY IN THE CARE OF CHILDREN.
ALL BRAKES ON CASTORS / WHEELS MUST BE APPLIED BEFORE PLACING YOUR CHILD ON THE CHANGE PAD OR IN THE BATH.
DO NOT ALLOW OLDER CHILDREN TO CLIMB OR PLAY ON THE CHANGE CENTRE.

This product has been manufactured for a child with a maximum age of **12 months** or a maximum weight of **11kgs**.

Be aware of the risk of open fires and other sources of heat, such as electric bar fires, gas fires, etc. in the near vicinity of the changing unit.

Use original accessories and manufacturer approved parts only.

DO NOT use this change pad if any part is torn, broken or missing.

ENSURE that the change centre is completely assembled and check that all parts are securely tightened before use.

Regularly check all parts for tightness - tighten or replace if required.

Promptly replace worn or broken parts.

Congratulations on your purchase of the **Montana Change Centre "White"** .

This product has been designed and developed with safety, comfort and functionality in mind. Please take the time to read this manual carefully before using this product and keep it in a safe place for future reference.

Contents

Assembly contents list

Assembly / Operating instructions

How to care for your **Montana Change Centre**

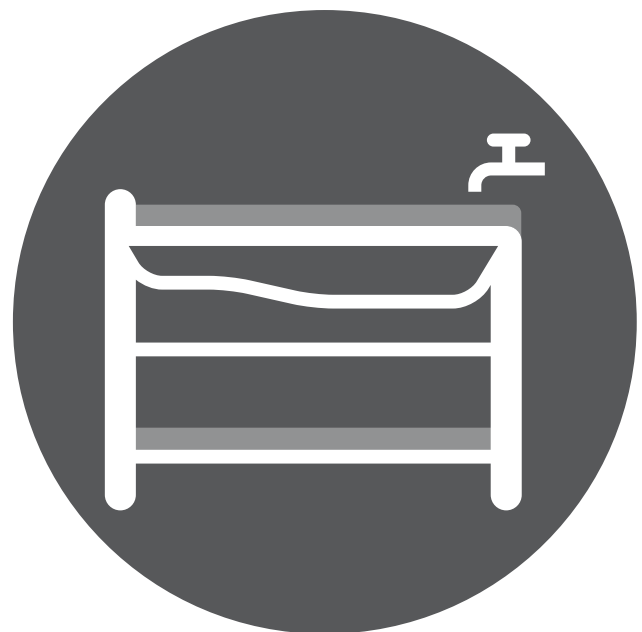





Due to variations in the style and design of our products, the photographs and illustrations shown in this instruction manual are generic, therefore product fabrics, colour and design may vary from images shown. CNP Brands reserves the right to alter product specifications without notice as a result of our ongoing policy of product improvement.

Check what you have received...



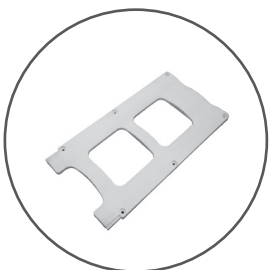

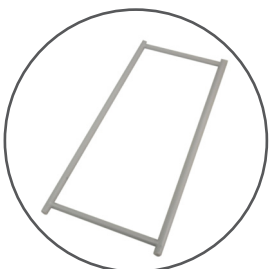

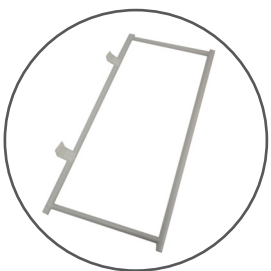
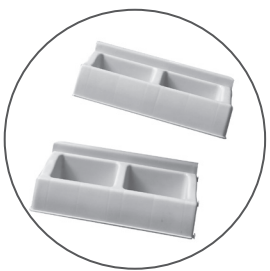
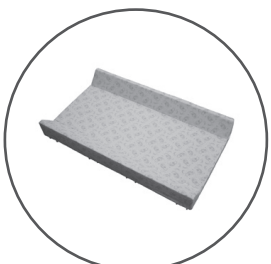
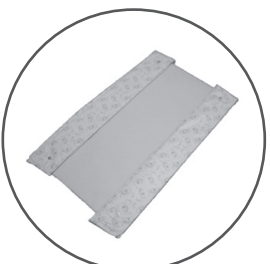
You have received **1 box**. Please check the contents of the box against the list below. If anything is missing, please contact Customer Service.

In Australia, contact **CNP Brands on 1300 667 137**, in New Zealand contact **Wainhouse Distribution on 0800 567 5000**.

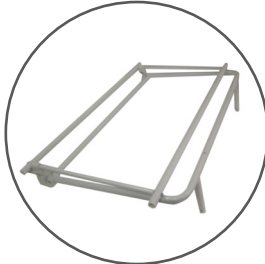
Supplied loose in box:

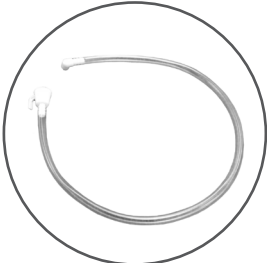
End panel		x 2	Bathtub		x 1
Rear frame without plastic brackets		x 1	Storage containers		x 3
Front frame with plastic brackets		x 1	Front tray (L+R)		x 1
Change pad		x 1	Bottom shelf		x 1

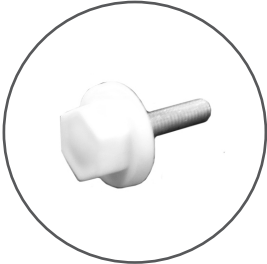
Supplied loose in box continued:

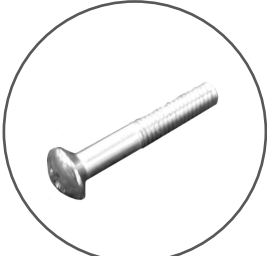
Castors		x 4	Pre assembled change pad frame		x 1
Plastic assembly tool		x 1	Bath frame support legs with floor protectors		x 2
Drain tube		x 1	Support tubes		x 2
Assembly bolt		x 12	Bath plug		x 1
40mm bolt for front frame bath support		x 4			

There are no accessories recommended for use with this Change Centre.

To attach pre-assembled Change Pad Frame...

PLEASE NOTE: You may need the help of another adult for assembly.

1

- 1a. Attach all four castors by pushing onto bottom of end panels.



2

- 2a. Insert pre-assembled change pad frame into one side of an end panel.

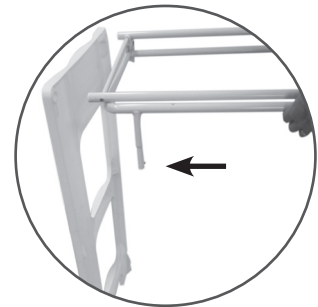

3

- 3a. Insert two assembly bolts and secure using plastic assembly tool.
3b. Repeat for other end.



PLEASE NOTE: Do not tighten completely.

To attach Front and Rear Frames...

1

- 1a. Insert front frame with plastic clips as per image shown.
1b. Insert two assembly bolts.
1c. Secure using plastic assembly tool.
1d. Repeat for opposite end.

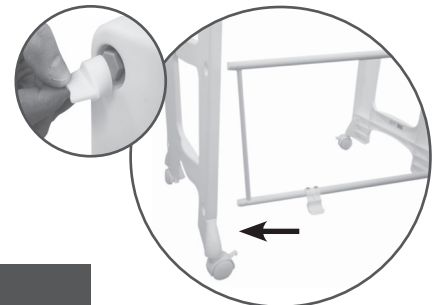

PLEASE NOTE: Do not tighten completely.

To attach Front and Rear Frames continued...

2

- 2a. Insert rear frame into both end panels.
- 2b. Using the same method as used for front frame assembly.



To assemble Bath Support Frame...

1

- 1a. Insert bath frame support leg onto bath frame tube.



2

- 2a. Ensure pop pins lock into hole.



3

- 3a. Secure top support tubes as shown in image using 2 x 40mm bolts either end.
- 3b. Repeat for bottom support tube using the remaining 2 x 40mm bolts.
- 3c. Use a Phillips head screwdriver (not supplied) to secure all 4 bolts.



To attach Bottom Shelf...

1

- 1a. Place bottom shelf in position as shown.
- 1b. Ensure the cut-outs in the shelf align with the plastic clips on the frame.



2

- 2a. Fold up sides and attach end flaps around vertical bars of side panels, using press studs to secure as shown.

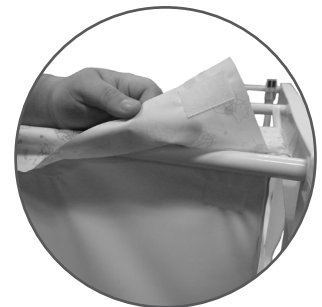

To attach change pad...

1

- 1a. Place change pad into position, and clip to one side of top frame.



2

- 2a. Lower down and clip other side of change pad to top frame.
- 2b. Attach drain hose to outlet on bathtub.

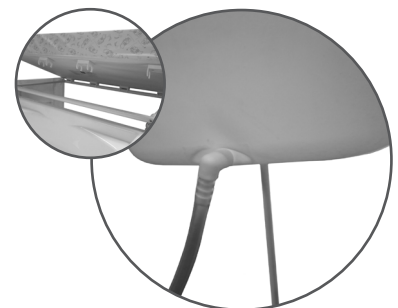

To assemble Plastic Components...

1

- 1a. Place the three storage containers into position on the upper rails of the front and rear frames, creating a shelf in the centre of the unit.



2

- 2a. Place the left component of the front tray into position, then place the right component ensuring it clips into the left component as shown.
- 2b. Ensure the front tray rests against the bar on the top frame.

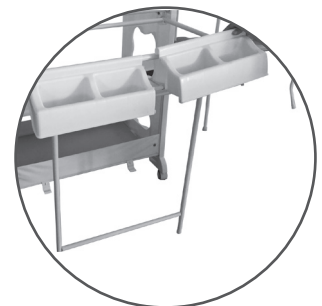

3

- 3a. Place bathtub into position as shown.

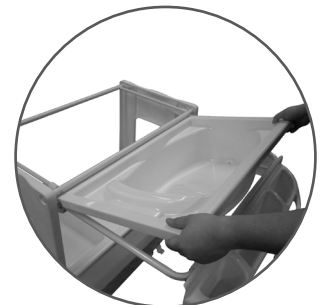

To access Bath...

1

1a. To access bath, slide bath outwards.



2

2a. When finished, slide bath back inwards, ensuring the bottom of the slide out frame clips into the plastic clips as shown.

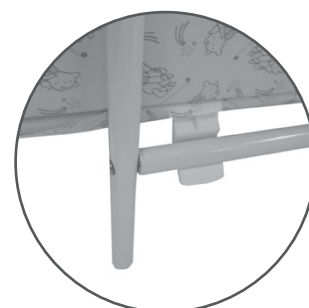



Cleaning

This product has been designed and developed with safety, comfort and functionality in mind. Please take the time to read this manual carefully before using this product and keep it in a safe place for future reference.

To ensure the long-lasting use of your change centre, wipe down with a damp cloth and use a mild soap solution if necessary. Do not use abrasive cleaners. Always store product in a clean dry place.

Maintenance

Always check parts regularly for tightness of screws, nuts and other fasteners – tighten or replace if required. To maintain the safety of your change centre seek prompt repairs for bent, torn, worn or broken parts. Use only those parts and accessories approved by **CNP Brands**.

If you have any difficulties in assembling the change centre, please contact our Service Department.

In Australia, contact **CNP Brands on 1300 667 137**, in New Zealand contact **Wainhouse Distribution on 0800 567 5000**.

Warranty

For all warranty information, please visit cnpbrands.com.au



CNP BRANDS®

CHILDCARE NURSERY PRODUCTS



Distributed in Australia by CNP Brands
82 Maribyrnong Street, Footscray, VIC,
3011 Customer Service 1300 667 137

W: www.cnpbrands.com.au
E: info@cnpbrands.com.au
F: www.facebook.com/CNPBrands
I: @cnp_baby

Distributed in New Zealand by Wainhouse
Distribution
2-6 Argyle St, Morningside,
PO Box 41-014,
St Lukes, Auckland, New Zealand
Customer Service: 0800 567 5000

E: helpline@wainhousedist.co.nz

