



Aero

Stroller "Black"

Model # 015265-002



**IMPORTANT:
RETAIN FOR FUTURE REFERENCE,
READ CAREFULLY**

Read all instructions before assembly and use of the stroller. Keep instructions for future use.

⚠ WARNING ⚠

TO AVOID INJURY OR DEATH:

ALWAYS APPLY THE BRAKES WHENEVER THE STROLLER IS STATIONARY.

DO NOT LEAVE CHILD UNATTENDED.

SECURE THE CHILD IN THE HARNESS AT ALL TIMES.

DO NOT CARRY EXTRA CHILDREN OR BAGS ON THIS STROLLER.

MAKE SURE CHILDREN ARE CLEAR OF ANY MOVING PARTS IF YOU ADJUST THE STROLLER.

TO AVOID INJURY ENSURE THAT YOUR CHILD IS KEPT AWAY WHEN FOLDING AND UNFOLDING THE STROLLER.

ENSURE THAT ALL LOCKING DEVICES ARE ENGAGED BEFORE USE.

Fingers or parts of the body could be injured when the stroller is being folded or unfolded. Please use caution when folding or unfolding the stroller.

Always check that safety locks are engaged before placing a child in the stroller.

Ensure your child is secured with a correctly adjusted safety harness.

Do not allow children to stand on the seat.

Do not hang bags or goods from the handle as this could cause the stroller to tip over.

Do not place more than **5kgs** in the basket.

Do not place more than **1kg** on the removable front tray.

Do not place more than **1kg** on the removable top parent tray.

The weight of the child using the product should not exceed **17kgs**.

The height of the child using the product should not exceed **96cm**.

It is unsafe to use parts other than those approved by the manufacturer.

Never ride with more than one child in the stroller.

Regularly inspect all parts and locking devices, promptly replace worn out or broken parts.

Remove the child from the stroller before going up or down stairs and escalators.

To prevent the risk of the stroller catching fire, do not park it near an open fire, heater or barbecue.

Do not make any changes, repairs or alterations to this product, unless through an approved service agent.

To avoid the risk of suffocation, keep all plastic packaging materials out of reach of children.

Never leave safety harness connected when not fitted to a child in the stroller as this may create loops that could cause a strangulation hazard.

The vehicle is designed for use on flat or gently sloping surfaces and may be unstable on higher sloping and uneven surfaces; and users should be made aware of the possibility of the vehicle tipping over.

Ensure the storage latch is fully engaged when lifting or carrying the stroller.

Congratulations on your purchase of the **Childcare Aero Stroller "Black"** .

This product has been designed and developed with safety, comfort and functionality in mind. Please take the time to read this manual carefully before using this product and keep it in a safe place for future reference.

Contents

Assembly contents list

Assembly / Operating instructions

How to care for your **Childcare Aero Stroller**













Due to variations in the style and design of our products, the photographs and illustrations shown in this instruction manual are generic, therefore product fabrics, colour and design may vary from images shown. CNP Brands reserves the right to alter product specifications without notice as a result of our ongoing policy of product improvement.

Check what you have received...

You have received **1 box**. Please check the contents of the box against the list below. If anything is missing, please contact Customer Service.

In Australia, contact **CNP Brands on 1300 667 137**, in New Zealand contact **Wainhouse Distribution on 0800 567 5000**.

Supplied loose in box:

Dual front swivel wheels		x 2	Rear axle		x 1
Washer		x 4	Wheel hub cap (for rear wheels)		x 2
Collet & collet cover		x 2	Rear wheels		x 2
Front tray		x 1	Stroller frame, with the following components pre-assembled on frame:		x 1
Rear tray		x 1	<ul style="list-style-type: none"> • Canopy • Five point safety harness • Basket • Seat lining 		x 1

There are no accessories recommended for use with this Childcare Stroller.

Unfolding the stroller...

- 1
 - 1a. Position the stroller frame on a stable floor.
 - 1b. Lift the stroller up-lock by unhooking it from the latch. (highlighted in the image)

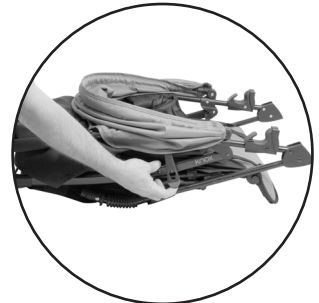

- 2
 - 2a. Lift the stroller handle to unfold the stroller.
 - 2b. The stroller should then lock into position.
 - 2c. This can be determined by a clicking sound once unfolded.



To assemble Dual Front Swivel wheels...

- 1
 - 1a. Push the front wheel onto the stroller front leg until it "clicks" into position.
 - 1b. Ensure the wheel is securely attached to the stroller front leg by pulling it downwards before use.
 - 1c. Repeat for other front wheel.



To operate Swivel Function...

- 1
 - 1a. To lock swivel wheels, push lever up.

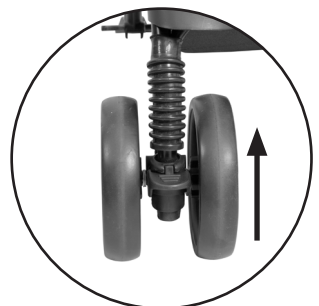

To operate Swivel Function continued...

- 2** 2a. To unlock swivel wheels, push lever down.

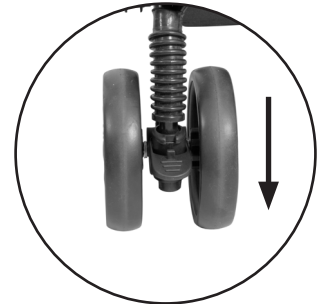

To assemble Rear Axle and Wheels...

- 1** 1a. Turn stroller over.
1b. To assemble the rear axle onto the stroller frame, align the rear axle with the stroller back legs. Ensure brake levers are facing away from the stroller, then gently push the rear axle onto the back legs until the push-pins 'click' into position.

NOTE: If you are having trouble pushing the axle into the locked position, consider depressing the locking pin before sliding the axle into position.

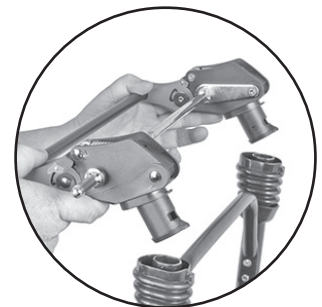

- 2** 2a. Place a washer on the rear wheel axle.
2b. Insert the rear wheel after the washer.
2c. Place another washer after the rear wheel.
2d. Fit a collet after the washer.
2e. Ensure that the key in the slot of the collet is correctly located in the axle's groove.
2f. Fit the collet cover to the collet by firmly pressing the collet cover into place.

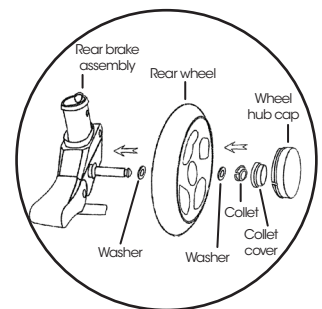

- 3** 3a. Push the wheel hub cap onto the wheel hub.

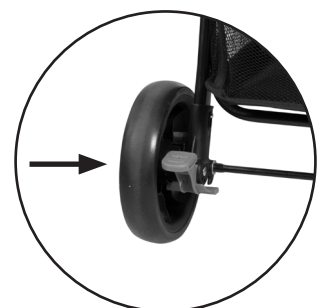

To assemble Rear Axle and Wheels continued...

- 4** 4a. Repeat for other wheel.



To operate Rear Brakes...

- 1** 1a. To lock the brakes, push down on the red left and right brake levers.
1b. To release brakes, lift up on each brake lever.

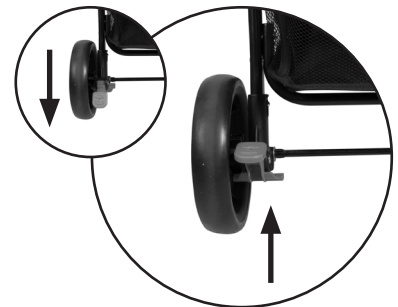

CAUTION: Always apply the brakes when parking stroller.

To attach the Front Tray...

- 1** 1a. Align the tray to the stroller frame.
1b. Ensure that the tray is positioned below the folding joint as shown.

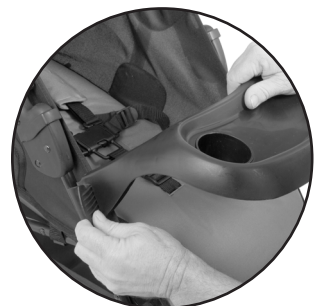

- 2** 2a. To lock the tray in place, push the tab inwards until it clicks into position.
2b. To remove the tray, simply undo the tabs by lifting them outwards.

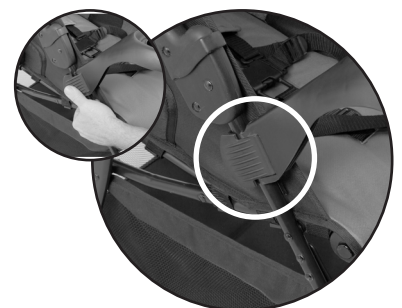

To attach the Rear Tray...

1

- 1a. Fit the rear tray in the space between the handle and the hood.
- 1b. Rest the tray over the side handle bars and ensure mounting lugs are secure in the tray holes.



To adjust the Leg Extension...

1

- 1a. Raise or lower the leg extension by pressing both buttons and lift up or down.
- 1b. Release both buttons to lock into place.



The stroller is now ready for use.

Adjusting the Backrest...

This stroller has a multiple position adjustable backrest. The upright position on the backrest is not suitable for use with children less than six months old.

For use with a newborn (0 - 6mths), the seat should be fully reclined. The backrest should only be adjusted to a more upright position as the child grows older and is able to support their head without assistance.

1

To Raise

- 1a. Push in and hold back rest adjustment button.
- 1b. Pull adjustment straps alternatively to adjust backrest to desired height.
- 1c. Release backrest adjustment button to secure.

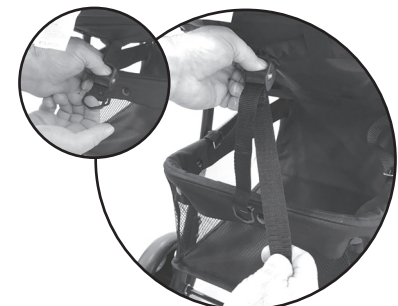

Adjusting the Backrest continued...

- 2**
- To Lower**
- 2a. Push in and hold back rest adjustment button.
 - 2b. Slide backrest adjuster down to desired height.
 - 2c. Release backrest adjustment button to secure.

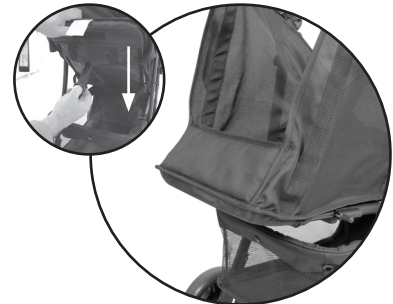

CAUTION: Do not adjust the backrest while child is in the stroller.

Using the Tether Strap...

- 1**
- 1a. Ensure tether strap is used at all times.
 - 1b. Make sure your hand is fed through the loop as shown in the diagram.



⚠ WARNING ⚠

USE THIS STRAP TO STOP THE STROLLER ROLLING AWAY

To adjust Canopy...

- 1**
- 1a. To open the canopy, pull forward.



- 2**
- 2a. To close the canopy, pull back.



CAUTION: The canopy must be fully closed before folding the stroller.

Restraints - Harness...

1 To secure the harness, insert each clip into the corresponding slot in the harness buckle.

2 Once all attached, carefully adjust the harness straps by pulling each slider until the desired fit is achieved in the lap, shoulder and crotch straps.

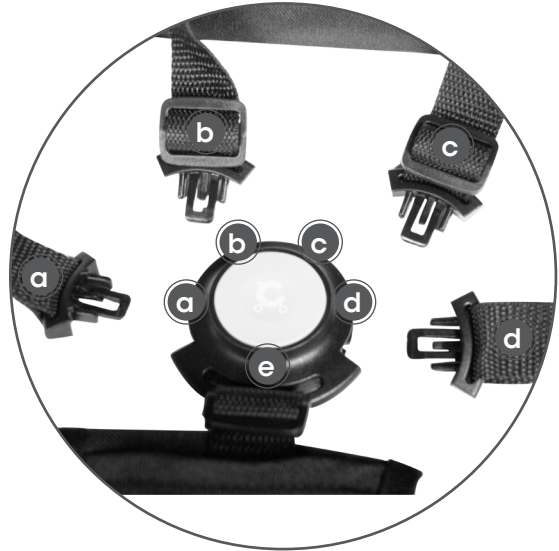

3 To release the buckle, press the centre button.

CAUTION: Always adjust the harness when changing the seating position of the child.

To adjust Harness Straps...

1

1a. To adjust straps, hold the strap with one hand and slide the adjuster up or down the strap.

1b. Sliding the adjuster down will loosen the strap, while sliding the adjuster up will tighten the strap.

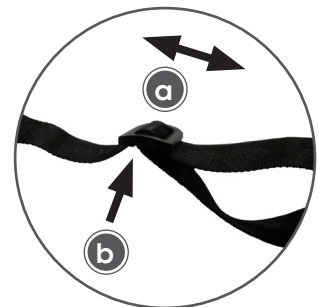

(a): Slide up or down
(b): Adjuster

To fold Stroller...

1

- 1a. Before folding the stroller, close the hood.
- 1b. Slide the lock lever to the right and twist centre handle forward.



2

- 2a. Push down on handle to commence folding the unit.



3

- 3a. Once the stroller is in the folded position, re-hook the stroller up-lock to ensure the stroller stays folded.





Cleaning

To ensure the long-lasting use of your stroller, dry it with a soft absorbent cloth after use in rainy weather. Use a damp cloth to clean the frame. Do not use abrasive cleaners. After using your stroller on the beach, clean the frame and wheels thoroughly with water to remove the sand and salt. Allow it to dry thoroughly. Removable and non-removable fabric covers and trims may be cleaned using a damp cloth with soap or mild detergent. Allow it to dry completely before folding or storing it away. Do not dry clean, or use bleach on fabrics or trims. Do not machine wash, tumble or spin dry, unless the care labelling on the product permits these methods.

Maintenance

Check stroller regularly to ensure that locking devices and components are secure and working properly. Always check parts regularly for tightness of screws, nuts and other fasteners – tighten or replace if required. To maintain the safety of your stroller, seek prompt repairs for bent, torn, worn or broken parts. Use only those parts and accessories approved by CNP Brands. If the wheels squeak, use silicone based spray or light oil ensuring it penetrates the wheel and axle assembly. To prevent mould or mildew, do not fold or store the product if it is damp or wet. Allow it to dry thoroughly. Always store the product in a well ventilated area and away from direct sunlight.

If you have any difficulties in assembling the stroller, please contact our Service Department. In Australia, contact **CNP Brands** on **1300 667 137**, in **New Zealand** contact **Wainhouse Distribution** on **0800 567 5000**.

Warranty

For all warranty terms and conditions, please visit cnpbrands.com.au



CNP BRANDS[®]

CHILDCARE NURSERY PRODUCTS

About CNP Brands

Currently, **CNP Brands** boasts one of the most diverse brand portfolios with a combination of company owned brands and distribution agreements. These include distribution lines for **Evenflo, Good Baby, Lascal, Maclaren, Project Nursery, Summer Infant and Yookidoo.**

Our own brands, including **Childcare**, have gone from strength to strength in recent years. **Childcare**, and our premium brand **bebe care**, demonstrate our commitment to quality and continuing investment in product development.



NOTES



A series of horizontal dotted lines for writing notes.

NOTES



A series of horizontal dotted lines for writing notes.



CNP BRANDS®

CHILDCARE NURSERY PRODUCTS



Distributed in Australia by CNP Brands
82 Maribyrnong Street, Footscray, VIC, 3011
Customer Service 1300 667 137

W: www.cnpbrands.com.au
E: info@cnpbrands.com.au
F: www.facebook.com/CNPBrands
I: [@cnp_baby](https://www.instagram.com/cnp_baby)

Distributed in New Zealand by Wainhouse
Distribution
2-6 Argyle St, Morningside,
PO Box 41-014,
St Lukes, Auckland, New Zealand
Customer Service: 0800 567 5000

E: helpline@wainhousedist.co.nz

