

NOSTALGIE

Nostalgie immediately states its vocation as a range, designed and made for the most demanding, skilled user. Its professional look is enhanced by its steel frame, offering burners rated up to 15,500 BTU/h. It is a fully fledged professional range for the domestic market.



UPN120FDM

48" Nostalgie Series Freestanding Double Oven Dual Fuel Range with 7 Sealed Burners and Griddle

COOKTOP

Fuel Type	Natural Gas / Liquid Propane
Burners/Elements	7 Sealed Burner
Surface	Deep Recessed Cooktop
Control	Knobs on Front Side
Grate Type	Cast Iron Grate

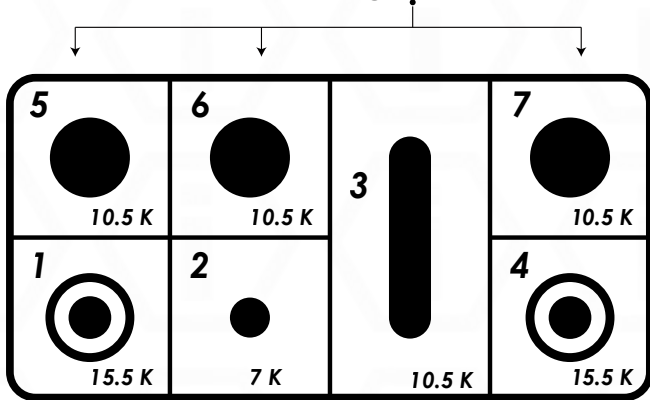
Large Burner

Dual Burner Small Burner Fish Burner Dual Burner

Oven	
Fuel	Electric Oven
Door Type	Removable Triple Layer Glass Door
Convection	Yes
Control Type	Knobs
Cleaning Type	Catalytic Oven Panel (Sold Separately)
Light(s)	Yes
Rack Holders	Plain
Soft Close Door	No
Broiler	Yes
Child Safety Lock	No
Timer	Yes
Built-in Thermostat	Yes
Internal Thermometer	No

INCLUDED

Range Hood	No
Power Cord	Yes
Grates	Yes
Griddle	Yes
Legs	Yes
Backsplash	Yes
Conversion Kit	Yes
Oven Racks	Yes
Oven Trays	Yes
Rotisserie	Yes
Gas Regulator	Yes
Manual	Yes

POWER

Voltage	240 Volts
Amperage	40 Amps
Hertz	60 Hertz
Power Cord Type	Hard Wire - 4 wire
Power Cord Length	45 11/16 inch / 116 cm

MISCELLANEOUS

Warranty	2 Years Limited Warranty
Range Weight	344 lbs lbs
Shipping Weight	364 lbs lbs
Shipping Dimensions	48 13/16 inch W x 33 15/16 inch H x 29 5/16 inch D

OVERALL DIMENSION

Overall Width (A)	47 4/16 inch / 120 cm
Overall Height without Backsplash (G)	39 9/19 inch / 100.5 cm
Overall Height with Backsplash (G1)	41 15/16 inch / 106.5 cm
Overall Depth without Handles (Q)	23 10/16 inch / 60 cm
Overall Depth with Handles (Q1)	25 13/16 inch / 65.5 cm

COOKTOP

Cooktop Width (A)	47 4/16 inch / 120 cm
Cooktop Height (D) (P)	1 9/16 inch / 4 cm
Cooktop Depth without Handles (Q)	23 10/16 inch / 60 cm
Cooktop Depth with Handles (Q1)	25 13/16 inch / 65.50 cm
Cooktop Front Lip Depth over Range (M)	9/16 inch / 1.5 cm
Cooktop Back Lip Depth over Range (N)	1 6/16 inch / 3.5 cm
Cooktop Handrail Length (E)	42 2/16 inch / 107 cm

RANGE BODY

Range Width (A)	47 4/16 inch / 120 cm
Range Height (C)	27 15/16 / 71 cm
Range Depth (H)	21 10/16 / 55 cm
Handle Length (E1)	28 15/16 inch / 73.5
Handle Length (E2)	12 3/16 inch / 31
Backsplash Width (A)	47 4/16 inch / 120 cm
Backsplash Height (O)	2 6/16 inch / 6 cm
Backsplash Depth (R)	9/16 inch / 1.5 cm
Power Position	From range's rear exterior bottom - 9 1/16 inch / 23 cm; From range's rear exterior left - 7 1/16 inch / 18 cm
Gas Connector Position	From range's rear exterior bottom - 3 9/16 inch / 9 cm; From range's rear exterior right - 9 7/16 inch / 24 cm

LEGS

Range Leg Type	4 / Cylinder Leg
Range Leg Height (B min)	6 2/16 inch / 15.5 cm
Range Leg Height (B max)	10 1/16 inch / 25.5 cm
Space Between Leg and Range (Side) (I)	8/16 inch / 1.2 cm
Space Between Leg and Range (Front) (K)	1 10/16 inch / 4.2 cm
Space Between Leg and Range (Back) (L)	8/16 inch / 1.2 cm

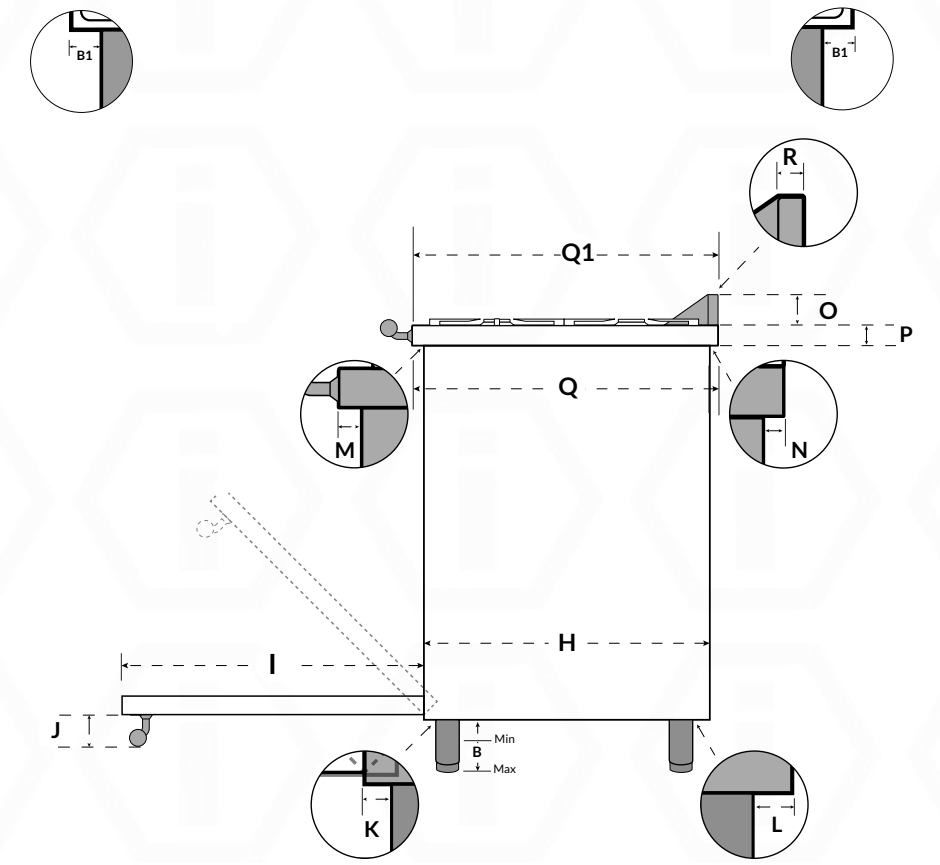
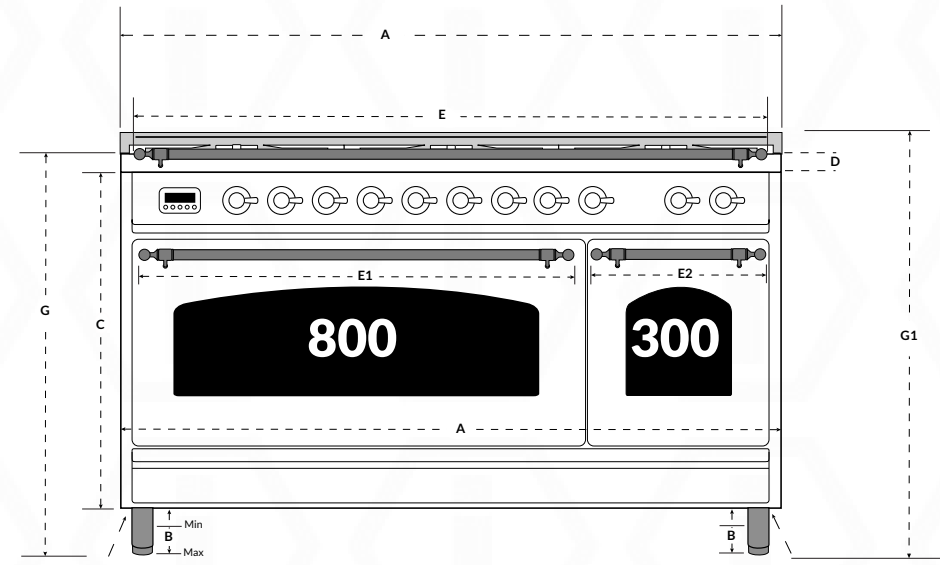

MAIN OVEN

Capacity	3.55 cu.ft.
Convection	Yes
Door Depth Open 90°	15 6/16 inch / 39 cm
Interior Width (Actual) (B)	25 3/16 inch / 64 cm
Interior Height (Actual) (A)	13 3/16 inch / 33.5 cm
Interior Depth (Actual) (C)	16 2/16 inch / 41 cm
Interior Width (Usable)	23 7/16 inch / 59.5 cm
Interior Height (Usable)	13 3/16 inch / 33.5 cm
Interior Depth (Usable)	41 cm / 33.5 cm
Height between racks	1 9/16 inch / 4 cm
Height between lowest and highest rack	7 14/16 inch / 20 cm
Lights	2 LED
Broiler	900W
Racks / Trays	2 Racks / 1 Tray
Rotisserie	Yes

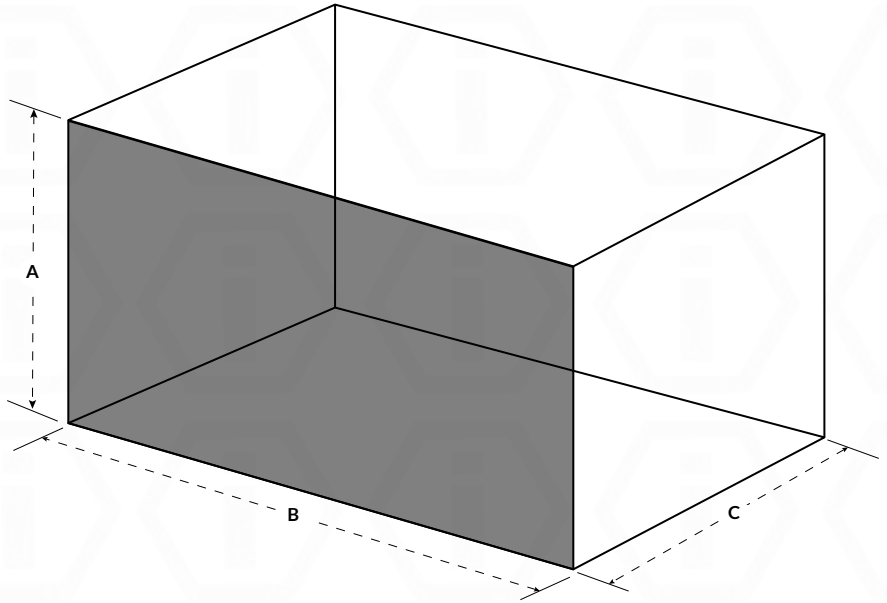
SECONDARY OVEN

Capacity	1.44 cu.ft.
Convection	-----
Door Depth Open 90°	15 6/16 inch / 39 cm
Interior Width (Actual) (E)	10 4/16 inch / 26 cm
Interior Height (Actual) (D)	13 3/16 inch / 33.5 cm
Interior Depth (Actual) (F)	16 2/16 inch / 41 cm
Interior Width (Usable)	8 7/16 inch / 21.5 cm
Interior Height (Usable)	13 3/16 INCH / 33.5 CM
Interior Depth (Usable)	16 2/16 inch / 41 cm
Height between Rack	1 9/16 inch / 4 cm
Height between lowest and highest rack	7 14/16 inch / 20 cm
Lights	1 LED
Broiler	800W
Racks / Trays	2 Racks
Rotisserie	Yes

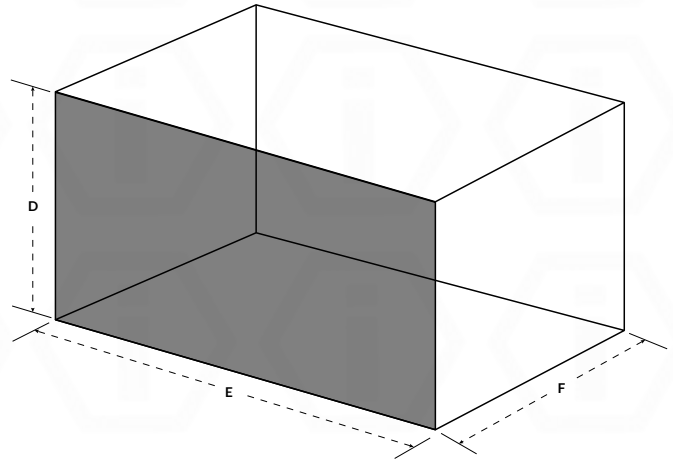
STORAGE

Type	Storage
Height (A)	3 2/16 inch / 8 cm
Width (B)	39 inch / 99 cm
Depth (C)	16 2/16 inch / 41 cm

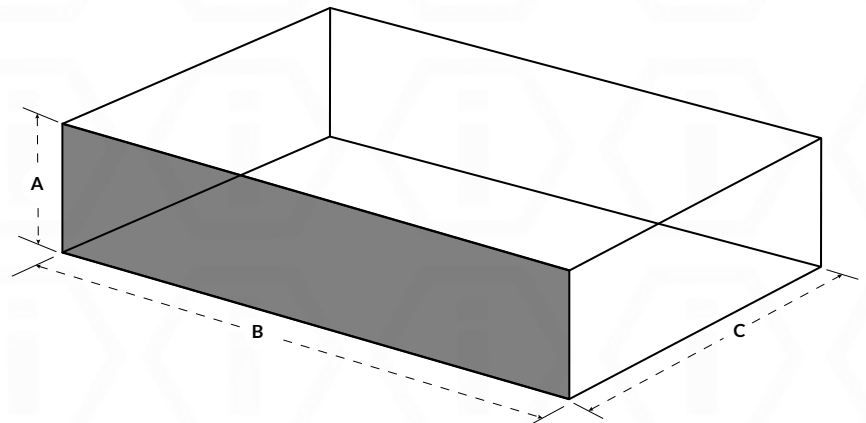

AVAILABLE COLORS

*Colors are available for every range.













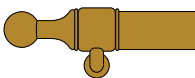

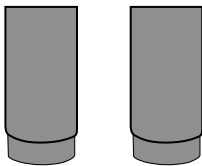



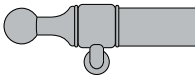

[CLICK COLORS TO SEE VARIATIONS](#)

*Trims

For all available RAL Colors [CLICK HERE](#)

*Trims

TRIMS & HARDWARE OPTIONS

	TRIMS	HANDRAILS	KNOBS	LEGS
 BRASS				STANDARD  
 CHROME				OPTIONAL *Sold Separately   
 BRONZE				*Sold Separately   

Decorative Scroll Claw Legs

DIMENSIONS		DESCRIPTION
1	14 inch / 336 mm	Recommended depth of top cabinet
2	18 inch / 547 mm	Minimum distance to bottom edge of top cabinet
3	35 1/2 inch-37 inch / 901mm-940 mm	Distance from the floor to cooktop surface
4	12 inch / 305mm	Minimum distance from cooktop surface
A	47 5/16 inch / 120.20 cm	Width of cabinet opening
B	28 inch / 71.12 cm to 32 inch / 81.28 cm	Minimum distance between the top of the cooking area and bottom of a range hood (check the hood's spec sheet for details)
C	47 5/16 inch / 120.20 cm	Width of the hood area
D	Approx. 10 13/16 inch / 274 mm	Maximum connection with right and left
E	Approx. 4 1/2 inch / 115 mm	Maximum connection height
F	Approx. 2 13/16 inch / 72 mm	Maximum connection depth

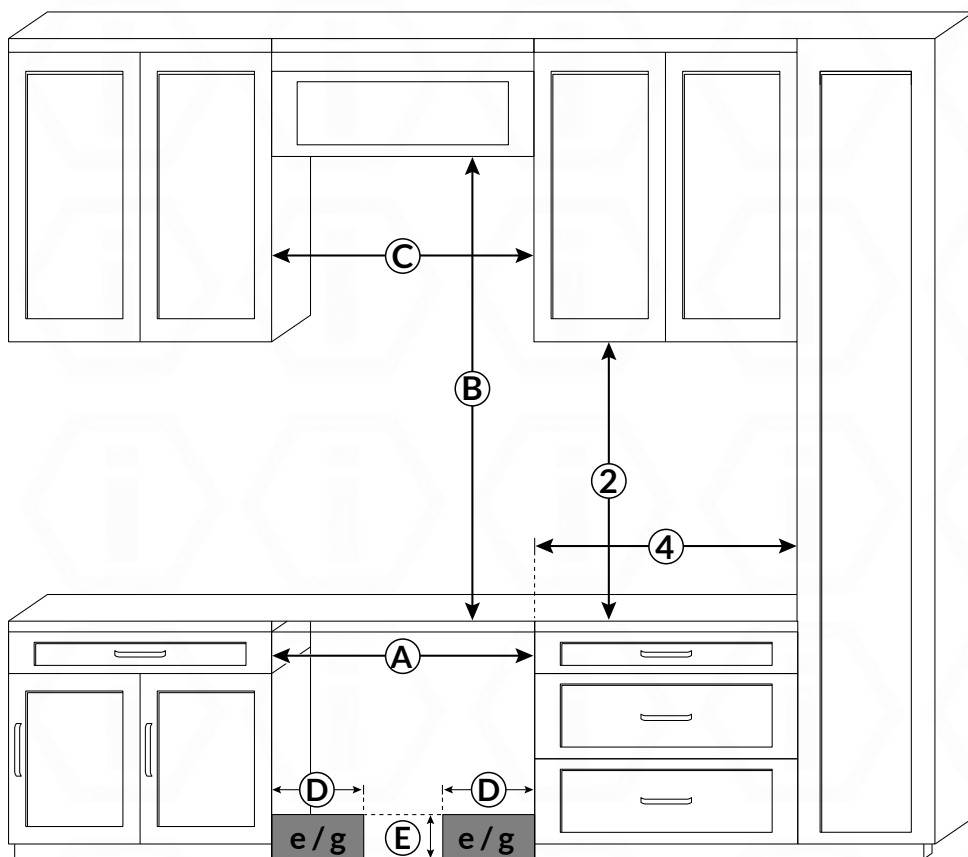
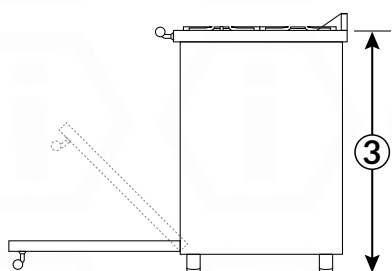
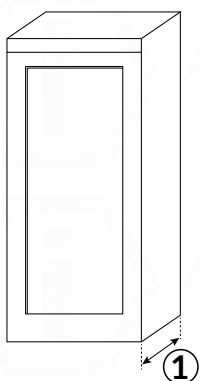

The shaded area represents the installation area for the connections

e = Electrical connection

g = Gas connection

One fuel type per side

FOLLOW US ON SOCIAL MEDIA

