

MAJESTIC II SERIES

A synthesis of beauty and functionality, the Majestic II series provides a premier cooking experience. As the centerpiece of your kitchen, it boasts handcrafted details such as rounded lines, custom finishes, ergonomic design, and innovative technology, inspired by the professional cooking world.



UMDI10
40" Majestic II Series Induction Range (Glass Door)

COOKTOP	
Fuel Type	Induction
Burners/Elements	6 Induction Element
Surface	Smoothtop Cooktop
Control	Knobs on Front Side
Grate Type	N/A

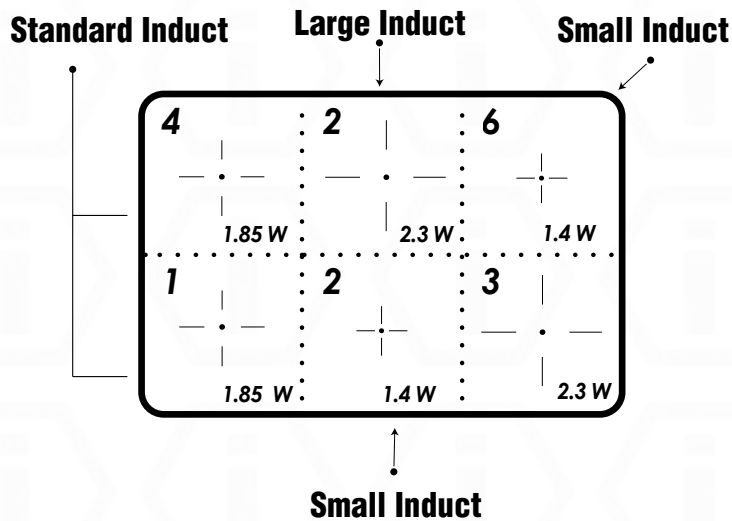

Oven	
Fuel	Electric Oven
Door Type	Removable Triple Layer Glass Door
Convection	Yes
Control Type	4.3" TFT Touch Screen on Front Side
Cleaning Type	Easy Clean Enamel Cavity
Light(s)	Yes
Rack Holders	Plain
Soft Close Door	Yes
Broiler	Yes
Child Safety Lock	Yes
Timer	Yes
Built-in Thermostat	Yes
Internal Thermometer	Yes

INCLUDED	
Range Hood	No
Power Cord	Yes
Grates	No
Griddle	No
Legs	Yes
Backsplash	Yes
Conversion Kit	No
Oven Racks	Yes
Oven Trays	Yes
Rotisserie	Yes
Gas Regulator	No
Manual	Yes

POWER	
Voltage	240 Volts
Amperage	50 Amps
Hertz	60 Hertz
Power Cord Type	Hard Wire - 4 wire
Power Cord Length	45 11/16 inch / 116 cm

MISCELLANEOUS	
Warranty	2 Years Limited Warranty
Range Weight	410 lbs
Shipping Weight	430 lbs
Shipping Dimensions	40 5/16 inch W x 35 2/16 inch H x 33 4/16 inch D

OVERALL DIMENSION	
Overall Width (A)	39 6/16 inch / 100 cm
Overall Height without Backsplash (G)	35 10/16 inch / 91 cm
Overall Height with Backsplash (G1)	35 15/16 inch / 96.5 cm
Overall Depth without Handles (Q)	27 9/16 inch / 70 cm
Overall Depth with Handles (Q1)	29 12/16 inch / 75.5 cm

COOKTOP	
Cooktop Width (A)	36 6/16 inch / 100 cm
Cooktop Height (D) (P)	1 9/16 inch / 4 cm
Cooktop Depth without Handles (Q)	27 9/16 inch / 70 cm
Cooktop Depth with Handles (Q1)	29 12/16 inch / 75.5 cm
Cooktop Front Lip Depth over Range (M)	2/16 inch / 0.3 cm
Cooktop Back Lip Depth over Range (N)	1 inch / 2.5 cm
Cooktop Handrail Length (E)	--- / ---

RANGE BODY	
Range Width (A)	39 6/16 inch / 100 cm
Range Height (C)	29 2/16 inch / 74 cm
Range Depth (H)	26 6/16 inch / 67 cm
Handle Length (E1)	21 1/16 inch / 53.5 cm
Handle Length (E2) (if applicable)	12 3/16 inch / 31 cm
Backsplash Width (A)	39 6/16 inch / 100 cm
Backsplash Height (O)	2 6/16 inch / 6 cm
Backsplash Depth (R)	9/16 inch / 1.5 cm
Power Cord Start Position	From range's rear exterior bottom - 7 1/16 inch / 18 cm; From range's rear exterior left - 5 14/16 inch / 15 cm
Gas Connector Position	--- / ---

LEGS	
Range Leg Type	4 / Plinth Leveling Legs
Range Leg Height (B min)	5 2/16 inch / 13 cm
Range Leg Height (B max)	5 2/16 inch / 13 cm
Space Between Leg and Range (Side) (1)	2/16 inch / 0.32 cm
Space Between Leg and Range (Front) (K)	1 12/16 inch / 4.5 cm
Space Between Leg and Range (Back) (L)	0 inch / 0 cm

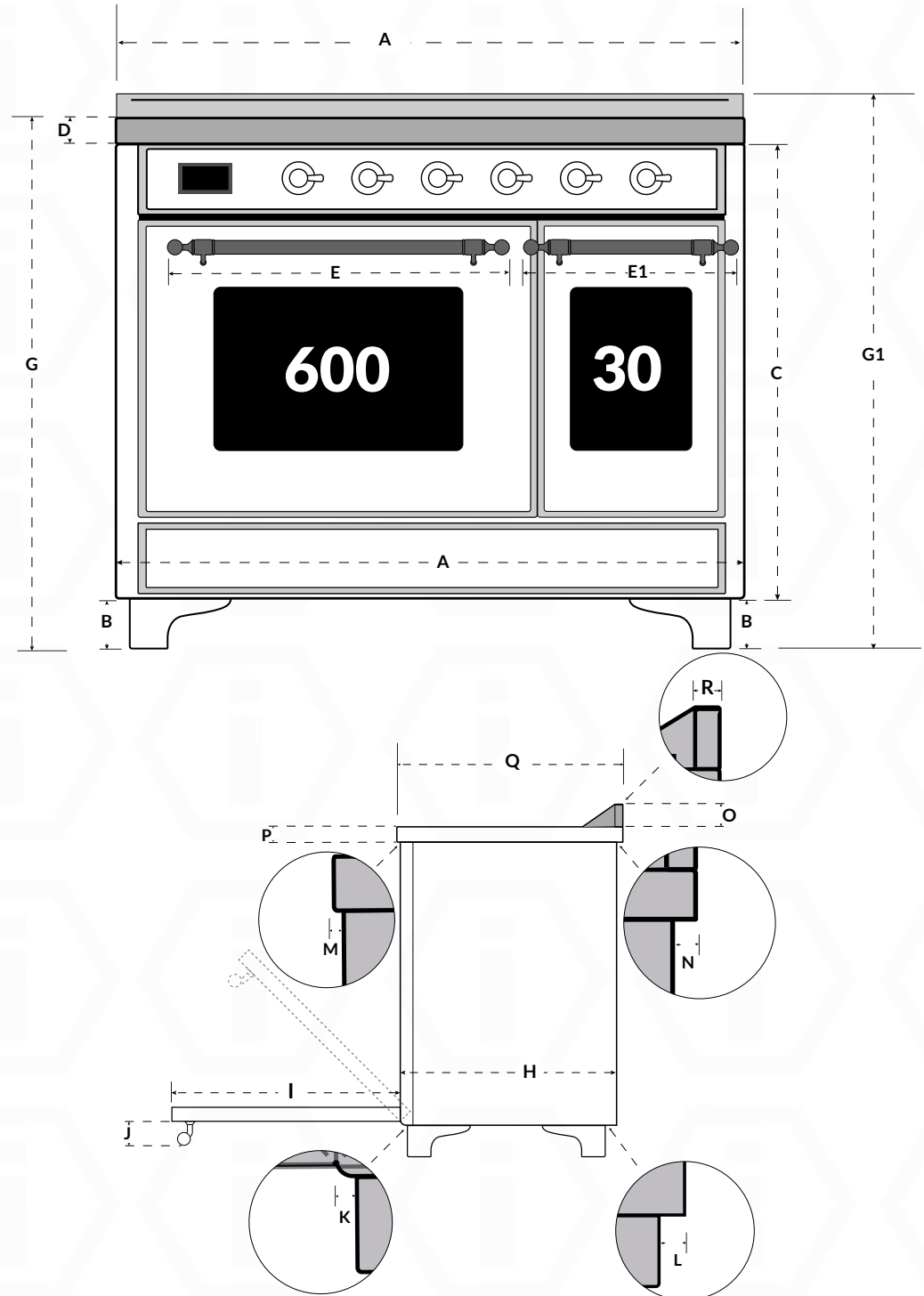

MAIN OVEN

Capacity	2.3 cu.ft.
Convection	Yes
Door Depth Open 90°	15 6/16 inch / 39 cm
Interior Width (Actual) (B)	17 2/16 inch / 43.5 cm
Interior Height (Actual) (A)	14 3/16 inch / 36 cm
Interior Depth (Actual) (C)	16 2/16 inch / 41 cm
Interior Width (Usable)	15 6/16 inch / 39 cm
Interior Height (Usable)	11 10/16 inch / 29.5 cm
Interior Depth (Usable)	36 cm / 29.5 cm
Height between racks	1 9/16 inch / 4 cm
Height between lowest and highest rack	7 14/16 inch / 20 cm
Lights	2 LED
Broiler	1000BTU
Racks / Trays	2 Racks / 1 Tray
Rotisserie	No

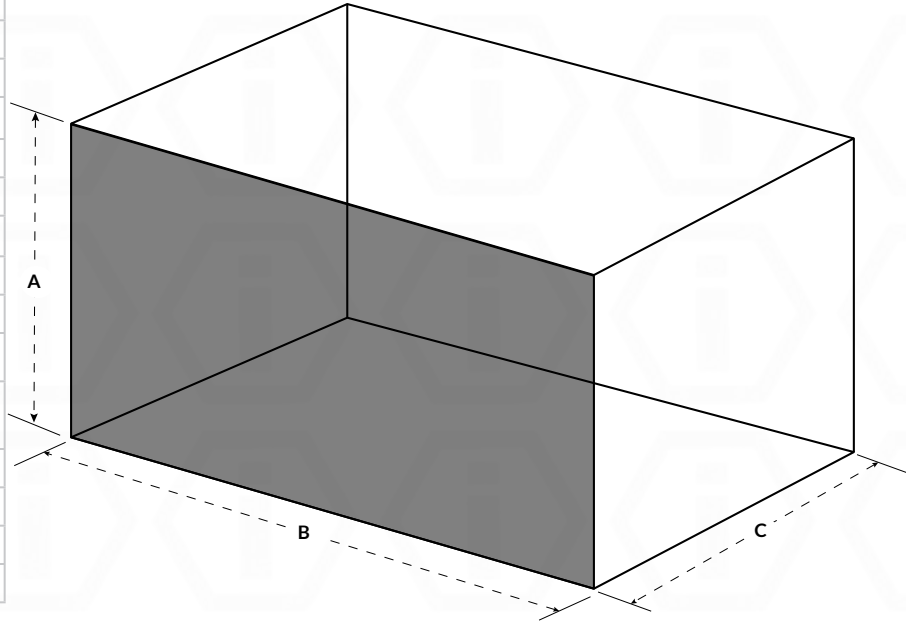
SECONDARY OVEN

Capacity cu.ft.	1.52 cu.ft.
Convection	N/A
Door Depth Open 90°	15 6/16 inch / 39 cm
Interior Width (Actual) (E)	10 4/16 cm / 26 cm
Interior Height (Actual) (D)	14 3/16 inch / 36 cm
Interior Depth (Actual) (F)	17 8/16 inch / 44.5 cm
Interior Width (Usable)	8 7/16 inch / 21.5 cm
Interior Height (Usable)	11 7/16 INCH / 29 CM
Interior Depth (Usable)	15 3/16 inch / 38.5 cm
Height between Rack	1 9/16 inch / 4 cm
Oven Functions	5 Functions
Height between lowest and highest rack	7 14/16 inch / 20 cm
Lights	1 LED
Broiler	800W
Racks / Trays	2 Racks
Rotisserie	Yes

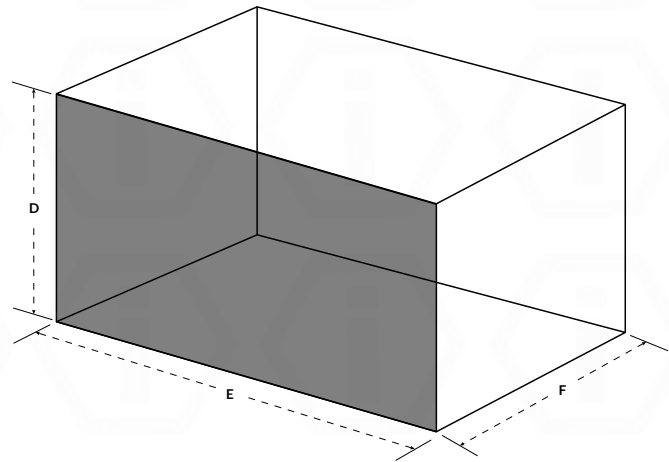
STORAGE

Type	Warming
Height (A)	2 12/16 inch / 7 cm
Width (B)	34 4/16 inch / 87 cm
Depth (C)	16 15/16 inch / 43 cm

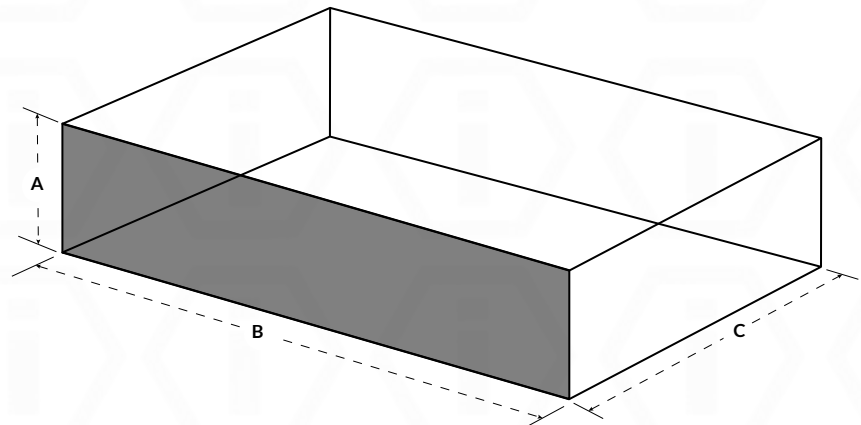











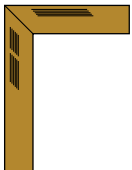
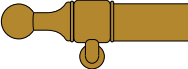

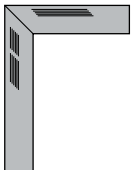
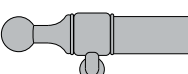
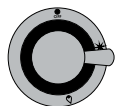

AVAILABLE COLORS

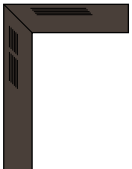
*Colors are available for every range.

[CLICK COLORS TO SEE VARIATIONS](#)

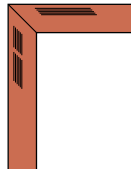
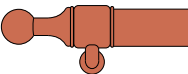
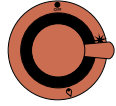
For all available RAL Colors [CLICK HERE](#)

TRIMS & HARDWARE OPTIONS

	TRIMS	HANDRAILS	KNOBS	LEGS
 BRASS				STANDARD 
 CHROME				
 BRONZE				
 COPPER				OPTIONAL *Sold Separately   

Decorative Scroll Claw Legs

DIMENSIONS	DESCRIPTION
1	14 inch / 356 mm Maximum depth of top cabinet
2	18 inch / 547 mm Minimum distance to bottom edge of top cabinet
3	35 ½ inch-37 inch / 901mm-940 mm Distance from the floor to cooktop surface
4	12 inch / 305mm Minimum distance from cooktop surface
A	39 7/16 inch / 100.2 cm Width of cabinet opening
B	28 inch / 71.12 cm to 32 inch / 81.28 cm Minimum distance between the top of the cooking area and bottom of an unprotected combustible surface
C	39 7/16 inch / 100.2 cm Width of the hood area
D	Approx. 10 13/16 inch / 274 mm Maximum connection with right and left
E	Approx. 4 ½ inch / 115 mm Maximum connection height
F	Approx. 2 13/16 inch / 72 mm Maximum connection depth

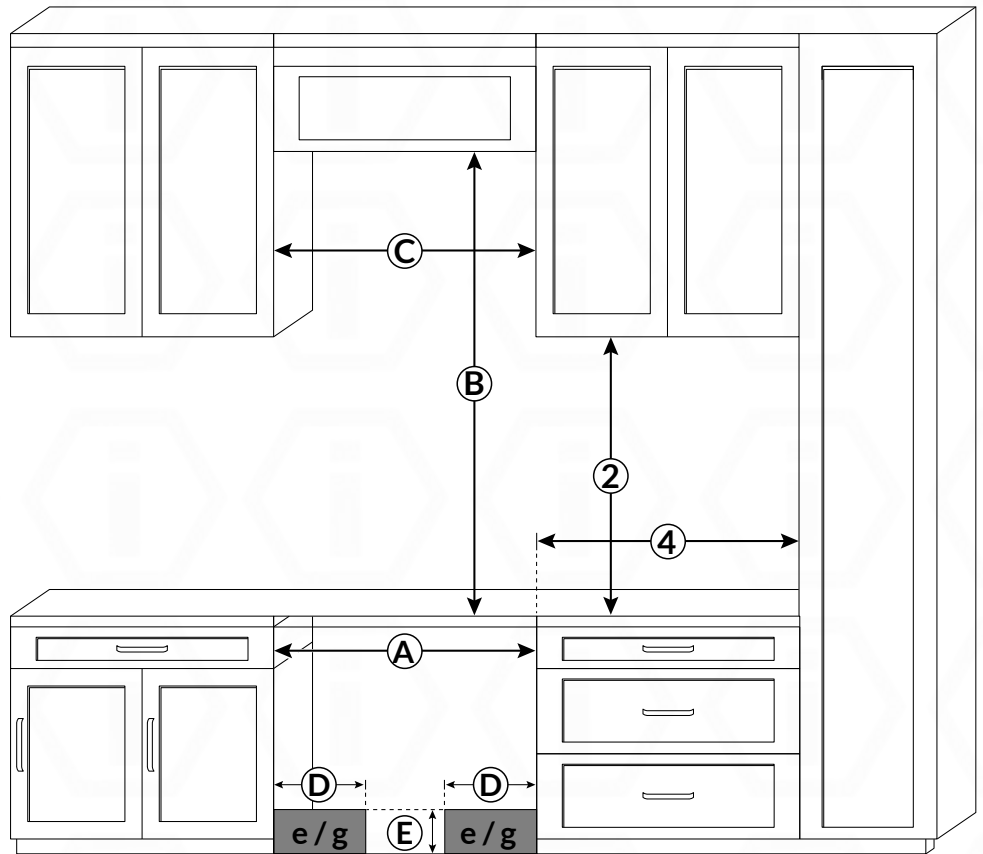
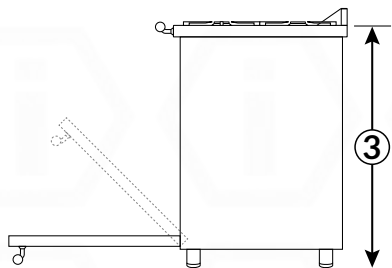
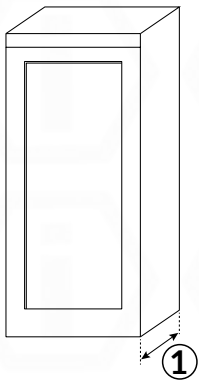

The shaded area represents the installation area for the connections
 e = Electrical connection
 g = Gas connection

One fuel type per side

FOLLOW US ON SOCIAL MEDIA

