

## STANDARD FEATURES



## ISLAND HOODS

- Unique CircuFlow Ventilation System™ with centrifugal blower design prevents grease and contaminants from collecting in ductwork for safe operation.
- Appropriate CFM specifications to perfectly match any Hestan cooking product (see specification recommendations) for optimized fume and grease extraction.

CircuFlow Ventilation System™

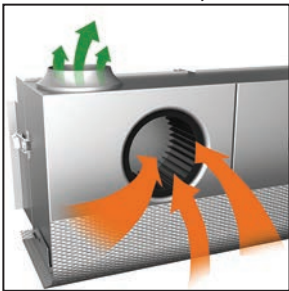

Removable blower Housing



LED lighting



12 Color Options



- Baffle-less, variable speed blower CircuFlow Ventilation System™ collects 70% more grease than most competing models.
- Ultra-quiet CircuFlow Ventilation System™ provides best-in-class air flow and extraction efficiency.
- Removable blower components are dishwasher-safe for easy cleaning.
- Optimized low-temp LED lighting for optimum illumination.
- Blower speed automatically increases when higher temperatures are detected and when full blower power is not needed the blower speed automatically lowers for even quieter operation.
- Marquise Accented™ front and back face profile compliments design integrity.
- Available in 36", 42", 54" widths.



KVI42 Model Shown

## OPTIONS & ACCESSORIES

- Available in Twelve (12) Hestan signature color finishes.
- Duct Covers in (12) colors.

NOTE : SEE INSTALLATION MANUAL FOR MORE DETAILS

*36" and 42" Hood*

*54" Hood*

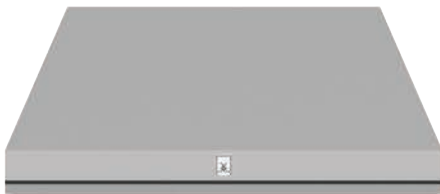
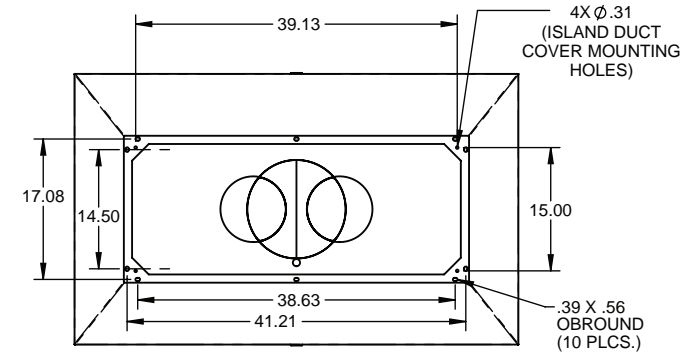
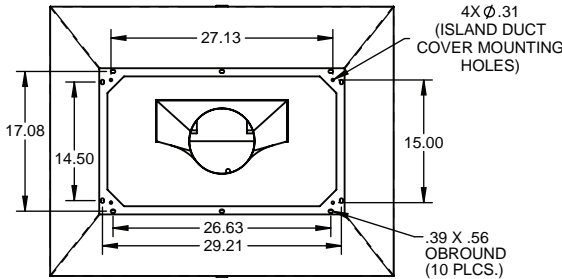
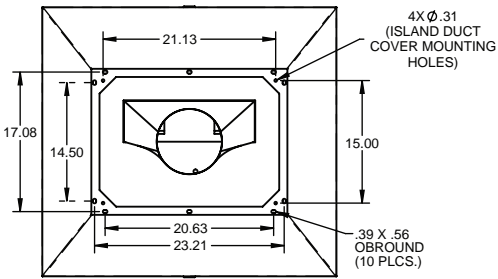
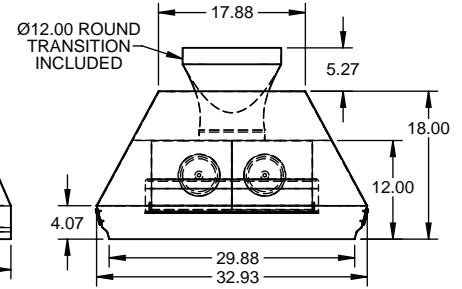
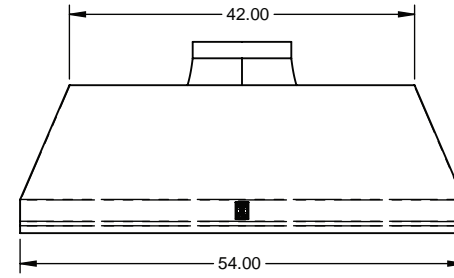
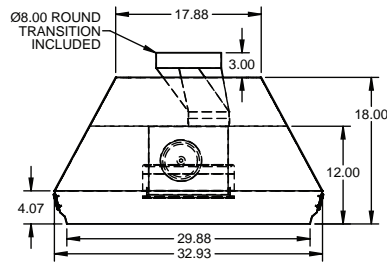
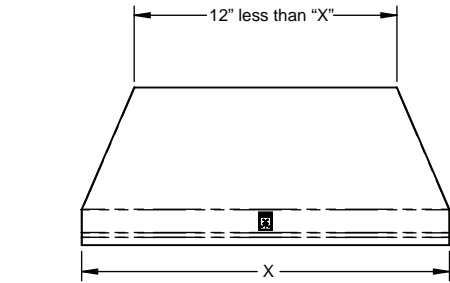

36"

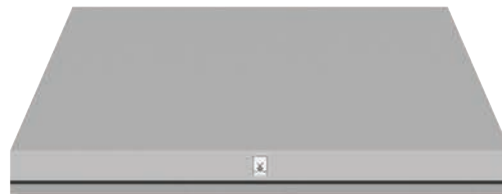

42"

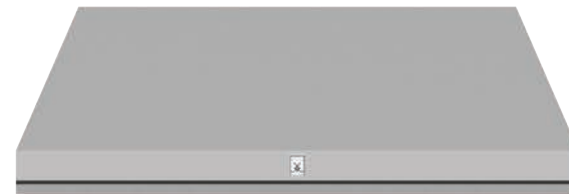

54"



ALL Models	Description	Width Dimensions X (in.)	Recommended for Rangetop Size	CFM SP@0.0"	Equivalent CFM**	Volts	Amps	Hz	RPM	Sones	# Lights	Approx SHP WT (lbs)
KVI36	36" Island Hood	35.88	30"	550	900	120	4.0	60	1550	6.0	4	125
KVI42	42" Island Hood	41.88	36"	550	900	120	4.0	60	1550	6.0	4	140
KVI54	54" Island Hood	53.88	48"	1100	1800	120	7.5	60	1550	6.4	6	185

\*\*When comparing the Hestan system with blower units made by other manufacturers, use the "Equivalent CFM"

Hestan Indoor products are approved for indoor use only. Hestan Commercial Corporation reserves the right to change materials and specifications without notice.