

**ZEPF<sup>®</sup>**



## Zepf Scissors

# Zepf Scissors

---

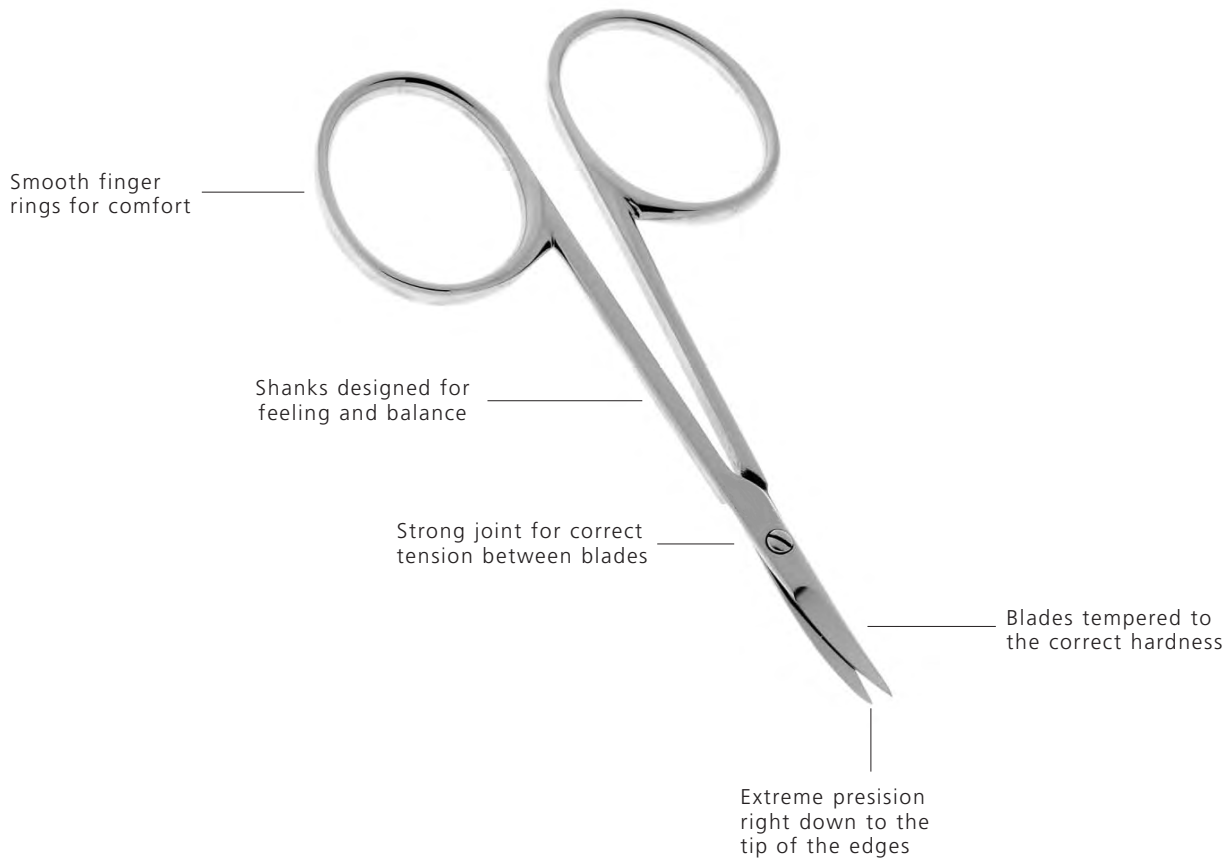

Zepf is world famous for our unique high quality scissors. Zepf scissors are extremely light and well balanced. They cut cleanly, not only when new, but also throughout their long life. This is due to careful attention to every part of the instrument during design and production.

Zepf scissors offer maximum cutting force for all kinds of soft tissue with a minimum of effort. They are available as ordinary stainless steel scissors, Super Cut scissors and Ergonomic scissors.



## Super Cut Scissors

### What are Super Cut Scissors?

Zepf Super Cut Scissors have an unrivaled cutting performance. In addition to incorporating all the advantages of conventional scissors, they are sharper.

### Why are Zepf Super Cut Scissors superior to ordinary scissors?

Because they have specially designed cutting edges – one scissors-ground and one knife-ground blade – the scissors actually cut their way through the tissue.



Super Cut edge

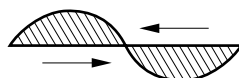

Ordinary edge

### What other advantages do Zepf Super Cut Scissors offer?

They cut with extreme precision right down to the points of the blades. The special grind makes them suitable both for right-handed and for left-handed surgeons.

### Are Zepf Super Cut Scissors all-purpose scissors?

Yes, in the case of tissue, because they cut coarse tissue as efficiently as fine, and with as great precision. Sutures must be avoided as they may damage the fine edges of the scissors. Special Zepf scissors are available for cutting sutures.

### Can you resharpen Super Cut Scissors?

Yes, of course. Just like any other scissors, Super Cut Scissors require sharpening occasionally. When it is time for regrinding, Zepf's own instrument service department will ensure that the scissors are taken care of with the utmost precision.

### How can you recognize Zepf Super Cut Scissors?

The shafts are black-chromed.



### Zepf Ergonomic Scissors

Surgical scissors are normally held in a precision grip, involving the thumb and the third or fourth finger. The grip works best when the hand is close to its basic resting position – a position that is the most comfortable. When using traditional scissors, the hand is not held in this position, but rather in a strained, more closed position.

The way to achieve this resting position is to use scissors with a shank design that is slightly different compared to traditional scissors.

The idea behind this new shape is ergonomics. By using ergonomically designed scissors, time consuming procedures can be performed with less strain on the hand. The effect of this is better comfort that enables the surgeon to avoid fatigue in the hand.

Of course the ergonomic scissors have the rest of the features of Zepf Super Cut Scissors.

Scissors should only be used for their intended purpose. Do not cut suture, gauze or wire with normal scissors or Super Cut scissors. To maintain the unique cutting performance, Super Cut scissors must be returned to Zepf Service for sharpening. Incorrect handling or use of Zepf scissors will invalidate the warranty.

### How to test Zepf scissors:

- Feel - smooth motion and soft resistance
- Cut - evenly, all the way to the tip
- Listen - no strange sounds
- Look – no visual damages on the blades

## ZEPF EYE SCISSORS

Delicate eye scissors with sharp or blunt tips and large finger rings. These are also called iris scissors and are used for nerves, tendons and vessels. They are intended for facial surgery and any type of delicate surgery. Beveled blades.

31-4011-95	Straight	Blunt	9.5 cm / 3.75"
* 31-4013-95	Straight	Sharp	9.5 cm / 3.75"
31-4021-95	Curved	Blunt	9.5 cm / 3.75"
31-4023-95	Curved	Sharp	9.5 cm / 3.75"

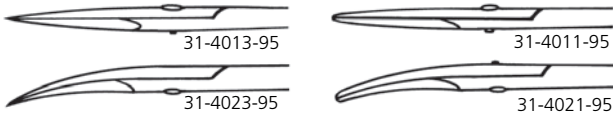

## ZEPF EYE SCISSORS

Eye scissors for delicate work. Large finger rings for a comfortable grip. Beveled blades.

31-4011-10	Straight	Blunt	10 cm / 4"
* 31-4013-10	Straight	Sharp	10 cm / 4"
31-4021-10	Curved	Blunt	10 cm / 4"
31-4023-10	Curved	Sharp	10 cm / 4"

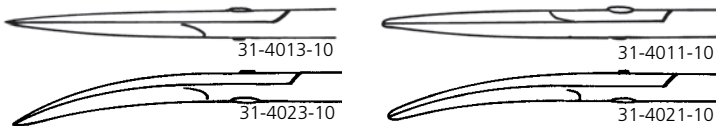

## ZEPF SUPER CUT EYE SCISSORS

Super Cut eye scissors with sharp or blunt tips and extremely sharp edges. Beveled blades.

* 31-4011-10SC	Straight	Blunt	10 cm / 4"
31-4013-10SC	Straight	Sharp	10 cm / 4"
31-4021-10SC	Curved	Blunt	10 cm / 4"
31-4023-10SC	Curved	Sharp	10 cm / 4"

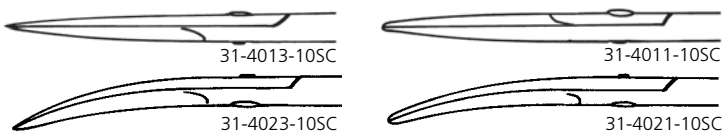

## ZEPF SUPER CUT BLEPHAROPLASTY

Short delicate Super Cut scissors suitable for blepharoplasty

- 31-4013-95SC Straight Sharp 9.5 cm / 3.75"
- \* 31-4023-95SC Curved Sharp 9.5 cm / 3.75"

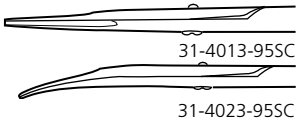

## ZEPF ERGO BLEPHAROPLASTY

Blepharoplasty Super Cut scissors with ergonomically designed shanks for a more relaxed grip.

- \* 31-4023-95SCE Curved Sharp 9.5 cm / 3.75"

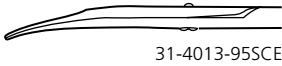

## RAGNELL SUPER CUT BLEPHAROPLASTY

Short delicate Super Cut scissors with blunt, flat tips for blepharoplasty.

- \* 31-8011-95SC Straight Blunt 9.5 cm / 3.75"
- 31-8021-95SC Curved Blunt 9.5 cm / 3.75"

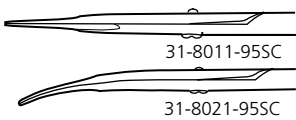

\* Photo shows this instrument

## RAGNELL ERGO BLEPHAROPLASTY

Blepharoplasty Super Cut scissors with ergonomically designed shanks for a more relaxed grip.

- \* 31-8021-95SCE Curved Blunt 9.5 cm / 3.75"

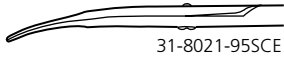

## KAYE

Scissors with serrated blades for "holding" the tissue, making it easier to cut exactly as far as intended.

- \* 31-8124-10 Curved Serrated Blunt 10 cm / 4"
- 31-8124-125 Curved Serrated Blunt 12.5 cm / 5"
- 31-8126-125 Curved Serrated Sharp 12.5 cm / 5"

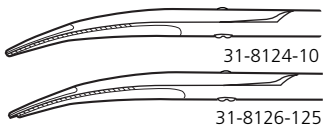

## PECK

Serrated scissors for excision of upper lateral cartilage

- \* 31-3516-15 Straight Serrated Sharp 15 cm / 6"

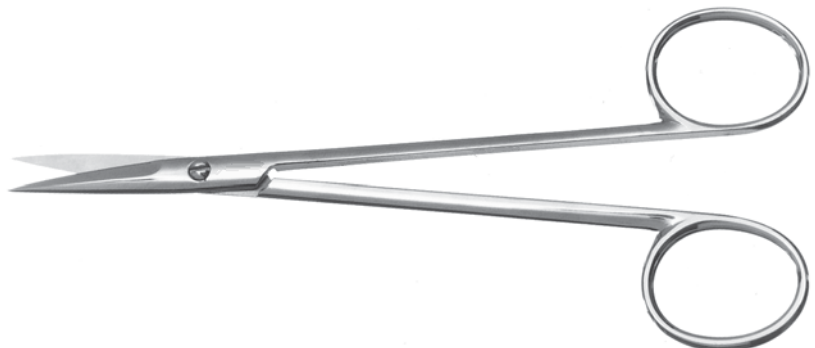
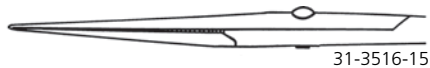

**FOMON**

Scissors for rhinoplasty. Double-beveled blades.

\* 31-6121-125 Curved Blunt 12.5 cm / 5"

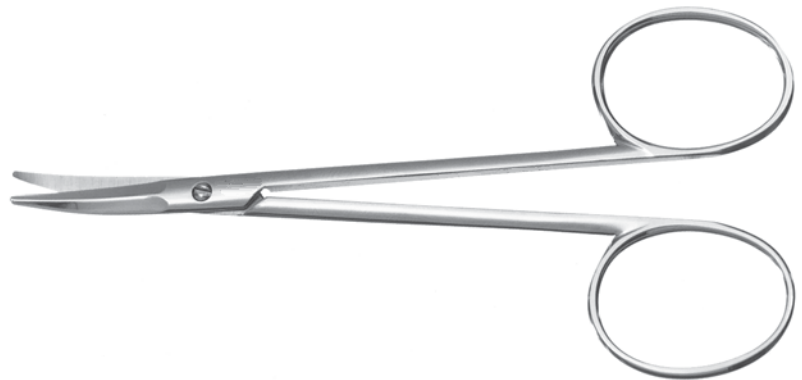

**KAYE**

Serrated dissecting scissors.

\* 31-8124-18 Curved Serrated Blunt 18 cm / 7"

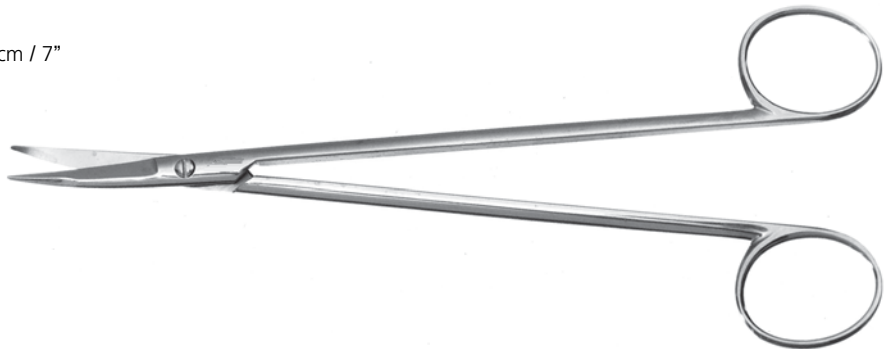
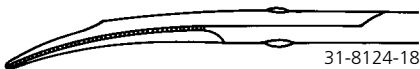

**JABALEY**

Sharp scissors suitable for hand surgery, where very strong scissors are used. Beveled blades.

\* 31-6213-125 Straight Sharp 12.5 cm / 5"  
 31-6223-125 Curved Sharp 12.5 cm / 5"

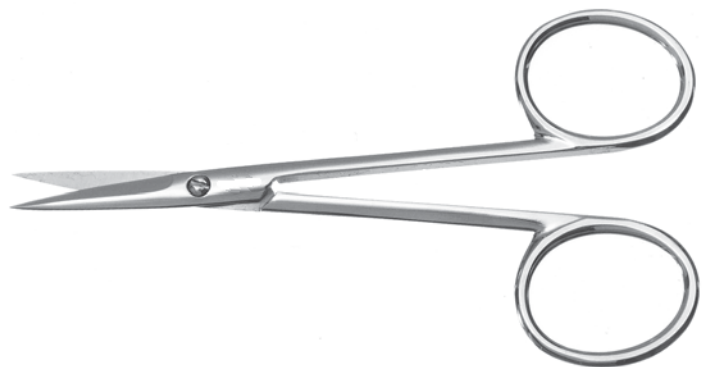
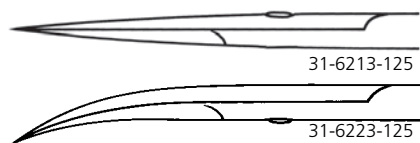

\* Photo shows this instrument



## JABALEY SUPER CUT

Super Cut scissors for dissection of tough tissue in hand surgery. Beveled blades.

* 31-6213-125SC	Straight	Sharp	12.5 cm / 5"
31-6223-125SC	Curved	Sharp	12.5 cm / 5"

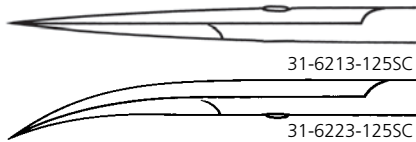

## JABALEY ERGO

Ergonomic model to avoid fatigue in the hand. Beveled blades.

* 31-6213-125SCE	Straight	Sharp	12.5 cm / 5"
31-6223-125SCE	Curved	Sharp	12.5 cm / 5"

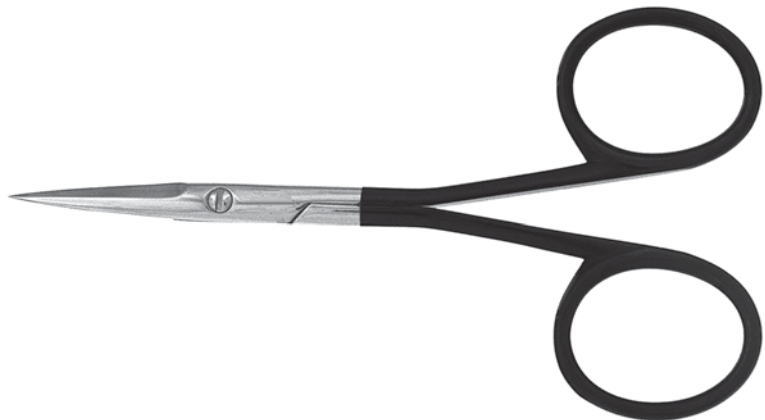
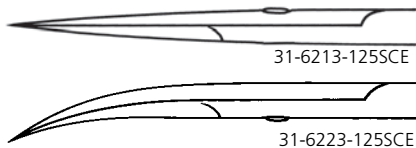

## MAYO-STILLE STYLE

The most used scissors, for all types of surgery. Used for routine dissection and cutting in tissue. Beveled blades.

31-5111-15	Straight	Blunt	15 cm / 6"
31-5111-17	Straight	Blunt	17 cm / 6.75"
* 31-5121-15	Curved	Blunt	15 cm / 6"
31-5121-17	Curved	Blunt	17 cm / 6.75"

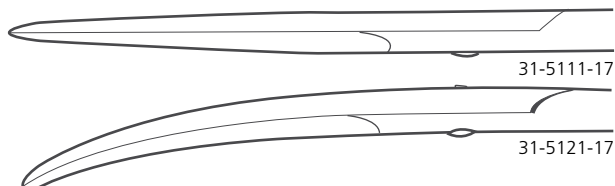
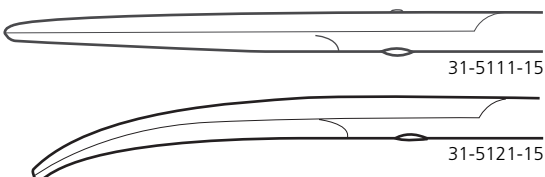

\* Photo shows this instrument

## MAYO-STILLE STYLE SUPER CUT

Super Cut dissecting scissors for tough tissue. Beveled blades.

- \* 31-5111-15SC Straight Blunt 15 cm / 6"
- 31-5121-15SC Curved Blunt 15 cm / 6"

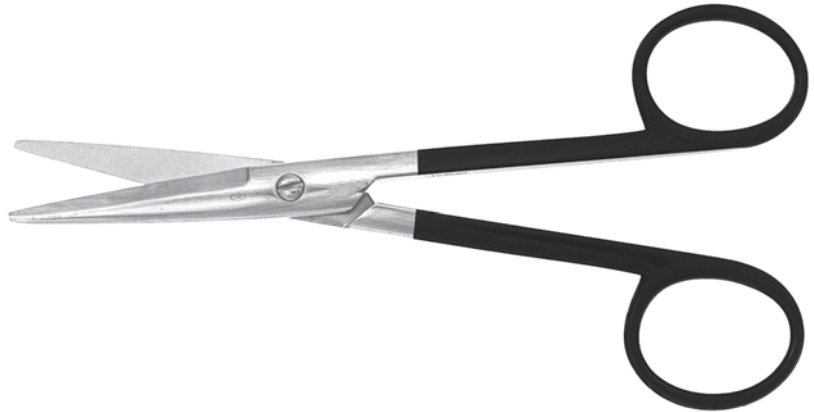

## MAYO

Sturdy dissecting scissors with rounded blades.

- \* 31-5011-15 Straight Blunt 15 cm / 6"
- 31-5011-17 Straight Blunt 17 cm / 6.75"
- 31-5011-19 Straight Blunt 19 cm / 7.5"
- 31-5021-15 Curved Blunt 15 cm / 6"
- 31-5021-17 Curved Blunt 17 cm / 6.75"
- 31-5021-19 Curved Blunt 19 cm / 7.5"



\* Photo shows this instrument

## MAYO SUPER CUT

Sturdy Super Cut scissors with rounded blades for dissection of tough tissue.

- 31-5011-15SC Straight 15 cm / 6"
- 31-5011-17SC Straight 17 cm / 6.75"
- 31-5011-19SC Straight 19 cm / 7.5"
- 31-5021-15SC Curved 15 cm / 6"
- \* 31-5021-17SC Curved 17 cm / 6.75"
- 31-5021-19SC Curved 19 cm / 7.5"

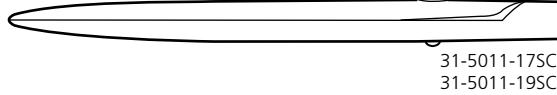
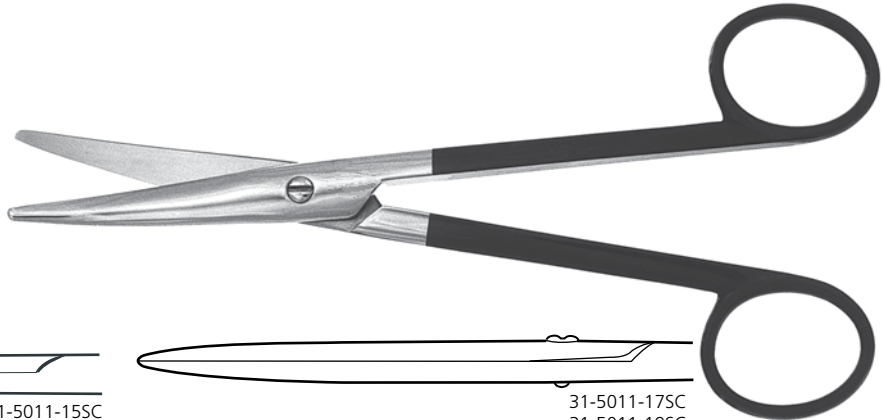

## MAYO ERGO

Ergonomic Super Cut model to avoid fatigue in the hand. Rounded blades. For dissection of tough tissue.

- 31-5021-15SCE Curved 15 cm / 6"
- \* 31-5021-17SCE Curved 17 cm / 6.75"



## MAYO-NOBLE

Short and strong dissecting scissors main for orthopaedic surgeons. Beveled blades.

- 31-5211-18 Straight 18 cm / 7"
- \* 31-5221-18 Curved 18 cm / 7"

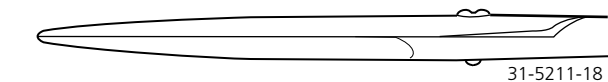

\* Photo shows this instrument

## BABY MAYO

Delicate version of the regular Mayo scissors. Mainly for plastic and hand surgery. Beveled blades.

- 31-5311-15 Straight 15 cm / 6"
- \* 31-5321-15 Curved 15 cm / 6"



## SIMS

Mainly used in gynecological and other pelvic surgery. Beveled blades.

- \* 31-8321-20 Curved Blunt 20 cm / 8"



## BABY METZENBAUM

Short, delicate dissecting scissors with rounded blades. Used in delicate surgery requiring small instruments.

- \* 31-7011-125 Straight Rounded Blades 12.5 cm / 5"
- 31-7021-125 Curved Rounded Blades 12.5 cm / 5"

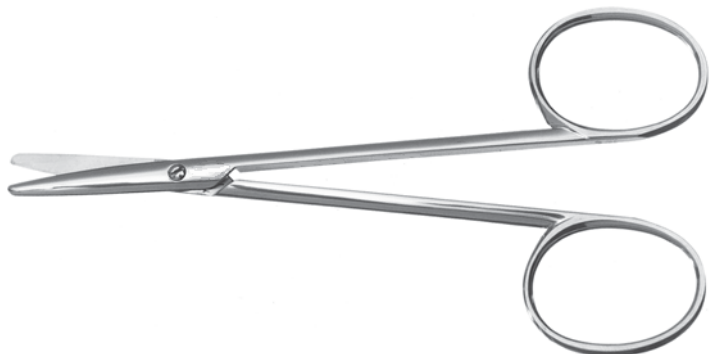
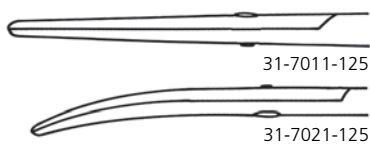

## BABY METZENBAUM SUPER CUT

Super Cut dissecting scissors for tough tissue. Used in delicate surgery requiring small instruments.

- \* 31-7011-125SC Straight Rounded Blades 12.5 cm / 5"
- 31-7021-125SC Curved Rounded Blades 12.5 cm / 5"

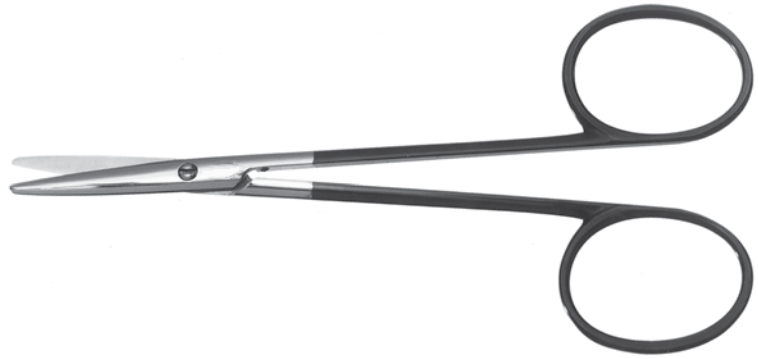
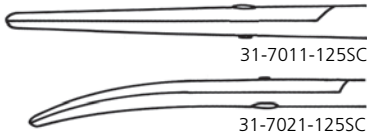

## BABY METZENBAUM ERGO

Ergonomic model for better control. Rounded blades.

- \* 31-7021-125SCE Curved 12.5 cm / 5"



## METZENBAUM DELICATE

Very delicate version of the popular Metzenbaum dissecting scissors. Rounded blades.

- \* 31-7021-18D Curved 18 cm / 7"
- 31-7021-23D Curved 23 cm / 9"

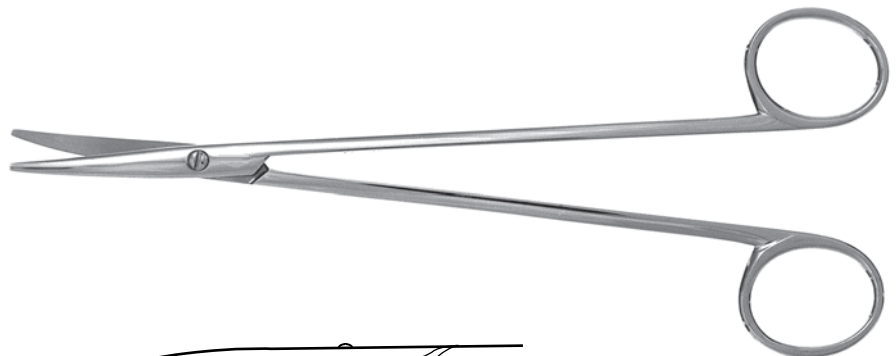
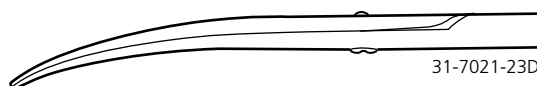

## METZENBAUM DELICATE SUPER CUT

Very delicate version with Super Cut edges and fine rounded tips.

31-7021-15SCD	Curved	15 cm / 6"
* 31-7021-18SCD	Curved	18 cm / 7"
31-7021-20SCD	Curved	20 cm / 8"

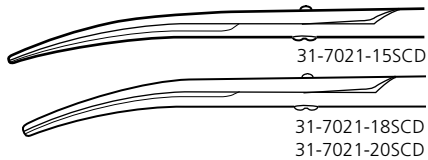

## METZENBAUM

Dissecting scissors with rounded blades and tips. Used in all specialties for fine dissection. Metzenbaum is one of Zepf's most popular scissors model and is available in a variety of shapes and sizes.

31-7021-15	Curved	15 cm / 6"
* 31-7021-18	Curved	18 cm / 7"
31-7021-20	Curved	20 cm / 8"
31-7021-23	Curved	23 cm / 9"
31-7021-26	Curved	26 cm / 10.25"

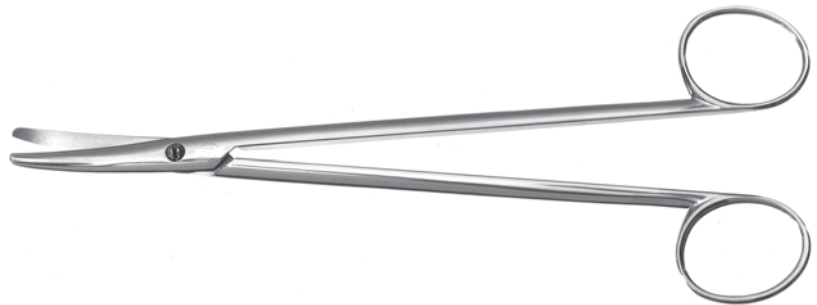

\* Photo shows this instrument

## METZENBAUM SUPER CUT

The popular Metzenbaum dissecting scissors with Super Cut edges. Rounded / beveled blades.

31-7011-15SC	Straight	15 cm / 6"
* 31-7011-18SC	Straight	18 cm / 7"
31-7011-20SC	Straight	20 cm / 8"
31-7011-23SC	Straight	23 cm / 9"
31-7011-26SC	Straight	26 cm / 10.25"
31-7021-15SC	Curved	15 cm / 6"
31-7021-18SC	Curved	18 cm / 7"
31-7021-20SC	Curved	20 cm / 8"
31-7021-23SC	Curved	23 cm / 9"
31-7021-26SC	Curved	26 cm / 10.25"
31-7021-30SC	Curved	30 cm / 12 "

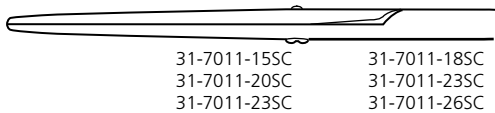
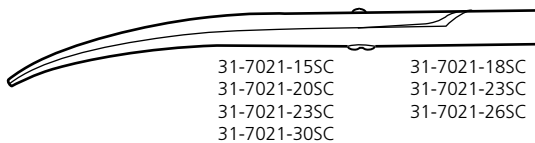
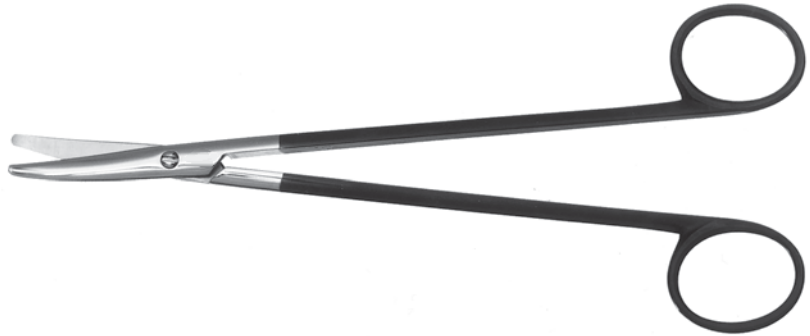

## METZENBAUM SUPER CUT ERGO

Metzenbaum Super Cut scissors with ergonomically designed shanks for a more comfortable grip. Rounded / beveled blades.

* 31-7021-15SCE	Curved	15 cm / 6"
31-7021-18SCE	Curved	18 cm / 7"

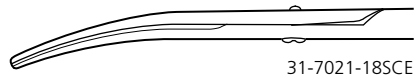
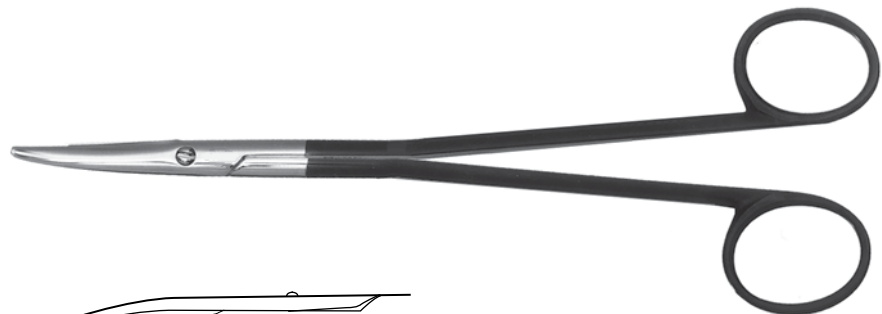

## RAGNELL

Dissecting scissors with flat, rounded tips. Often used in plastic surgery. Is also called Killner by some manufacturers. The short models are used for undermining in plastic surgery and the long models are used for further dissection.

* 31-8011-125	Straight	12.5 cm / 5"
31-8021-125	Curved	12.5 cm / 5"
31-8021-15	Curved	15 cm / 6"
31-8021-18	Curved	18 cm / 7"
31-8021-20	Curved	20 cm / 8"
31-8021-23	Curved	23 cm / 9"
31-8041-125	Strongly Curved	12.5 cm / 5"

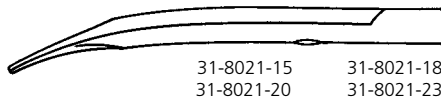
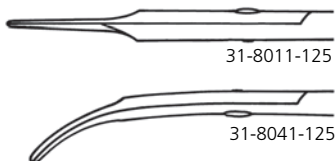
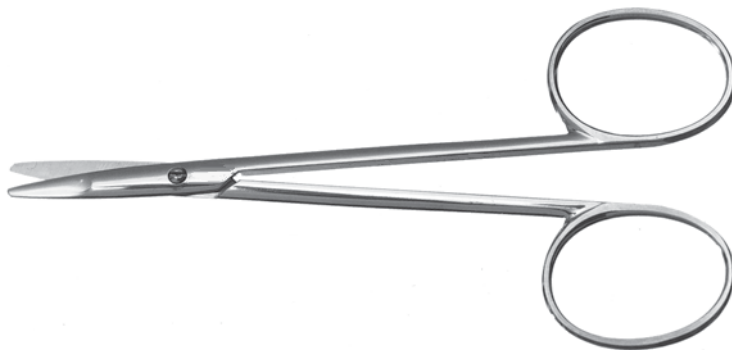

## RAGNELL SUPER CUT

Super Cut version of the Ragnell scissors. For precise undermining of flaps.

31-8021-125SC	Curved	12.5 cm / 5"
31-8021-15SC	Curved	15 cm / 6"
31-8021-18SC	Curved	18 cm / 7"
* 31-8021-20SC	Curved	20 cm / 8"
31-8021-23SC	Curved	23 cm / 9"

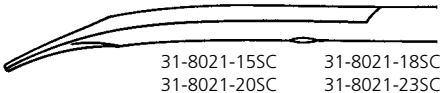
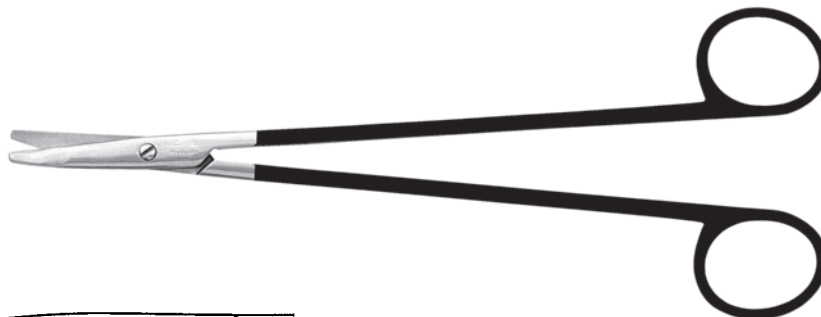

## RAGNELL SUPER CUT ERGO

Ergo Super Cut versions of Ragnell scissors for precise undermining of flaps and comfortable grip.

* 31-8021-125SCE	Curved	12.5 cm / 5"
31-8021-15SCE	Curved	15 cm / 6"

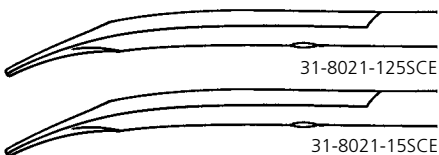

\* Photo shows this instrument



## THOREK

Strongly Curved dissecting scissors for good visibility. Rounded blades.

\* 31-8441-21 Strongly Curved 21 cm / 8.25"

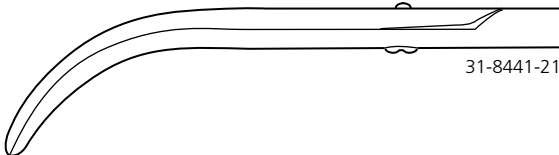

## COOPER

General purpose utility scissors, often used for sutures, gauze etc. Beveled blades.

- |              |          |               |                 |
|--------------|----------|---------------|-----------------|
| 31-8511-15   | Straight | Blunt / Blunt | 15 cm / 6"      |
| * 31-8512-15 | Straight | Sharp / Blunt | 15 cm / 6"      |
| 31-8521-15   | Curved   | Blunt / Blunt | 15 cm / 6"      |
| 31-8522-135  | Curved   | Sharp / Blunt | 13.5 cm / 5.25" |
| 31-8522-15   | Curved   | Sharp / Blunt | 15 cm / 6"      |

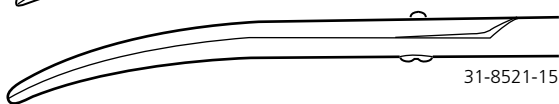
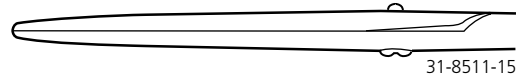
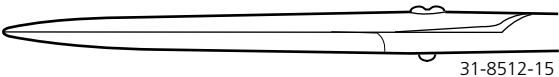

## MAYO-HARRINGTON

Very useful operating scissors for deep surgery like gynecology and thoracic surgery. Beveled blades.

31-5011-20	Straight	20 cm / 8"
31-5011-23	Straight	23 cm / 9"
* 31-5021-20	Curved	20 cm / 8"
31-5021-23	Curved	23 cm / 9"
31-5021-30	Curved	30 cm / 12"



## MAYO-HARRINGTON SUPER CUT

Operating Super Cut scissors useful for thoracic surgery and gynecology. Beveled blades.

31-5011-20SC	Straight	20 cm / 8"
31-5011-23SC	Straight	23 cm / 9"
* 31-5021-20SC	Curved	20 cm / 8"
31-5021-23SC	Curved	23 cm / 9"
31-5021-30SC	Curved	30 cm / 12"



Profiles identical to Mayo-Harrington model above.

\* Photo shows this instrument

## BOYD

Scissors with sharp tips and S-shaped shanks for greater visibility. Rounded blades.

\* 31-8223-17 Curved Sharp 17 cm / 6.75"



## RAGNELL-STILLE

Mammary plastic scissors intended for breast surgery. Rounded blades.

\* 31-8021-17 Angled on Flat 17 cm / 6.75"

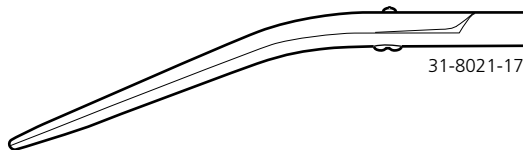

## KÖNIG

Nail-splitting scissors, for cutting up ingrown nails. Beveled blades.

\* 31-6512-15 Straight Sharp / Blunt 15 cm / 6"

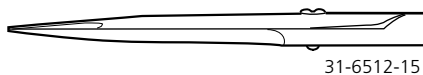

## LITTLER

Suture carrying scissors. Rounded blades.

\* 31-6321-125 Curved 12.5 cm / 5"

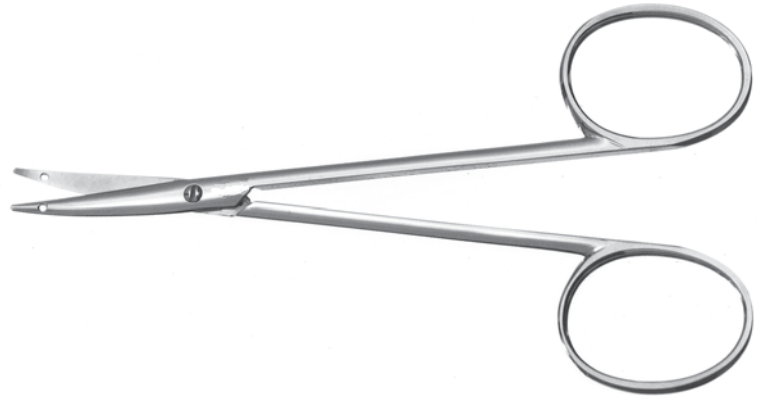

## STEVENS

Tenotomy scissors with rounded, very thin blades and tapered tips. Used in plastic surgery and hand surgery for cutting with extreme precision in small incisions.

\* 31-2013-125 Straight Sharp 12.5 cm / 5"  
31-2023-125 Curved Sharp 12.5 cm / 5"

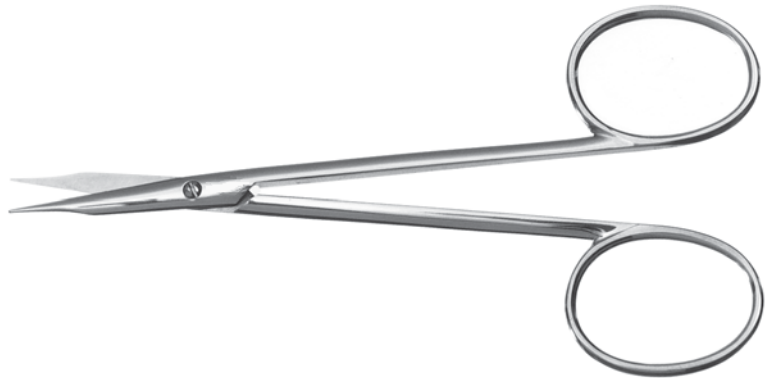

## STEVENS SUPER CUT

Very popular Super Cut scissors for precise cutting and dissection of fine tissues. Rounded blades.

31-2013-95SC Straight Sharp 9.5 cm / 3.75"  
31-2023-95SC Curved Sharp 9.5 cm / 3.75"  
\* 31-2013-125SC Straight Sharp 12.5 cm / 5"  
31-2023-125SC Curved Sharp 12.5 cm / 5"  
31-2023-15SC Curved Sharp 15 cm / 6"  
31-2023-18SC Curved Sharp 18 cm / 7"

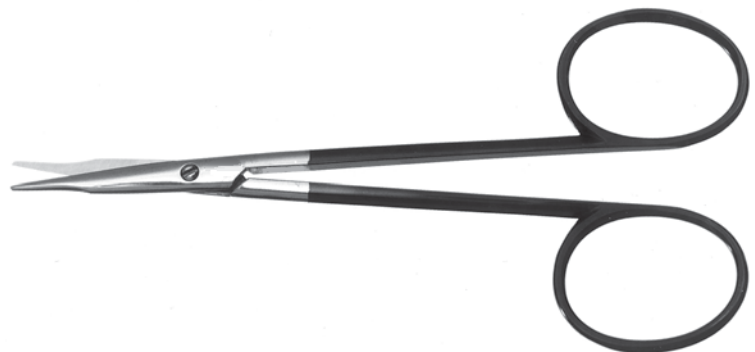
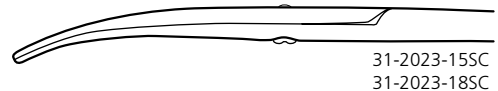
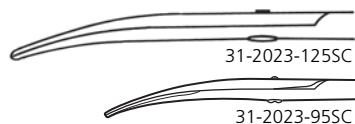
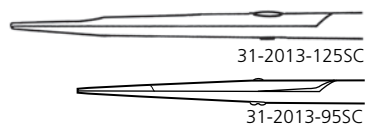

\* Photo shows this instrument

## STEVENS SUPER CUT ERGO

Ergonomic design of the popular Stevens Super Cut tenotomy scissors.

* 31-2013-125SCE	Straight	Sharp	12.5 cm / 5"
31-2023-125SCE	Curved	Sharp	12.5 cm / 5"
31-2023-15SCE	Curved	Sharp	15 cm / 6"
31-2023-18SCE	Curved	Sharp	18 cm / 7"

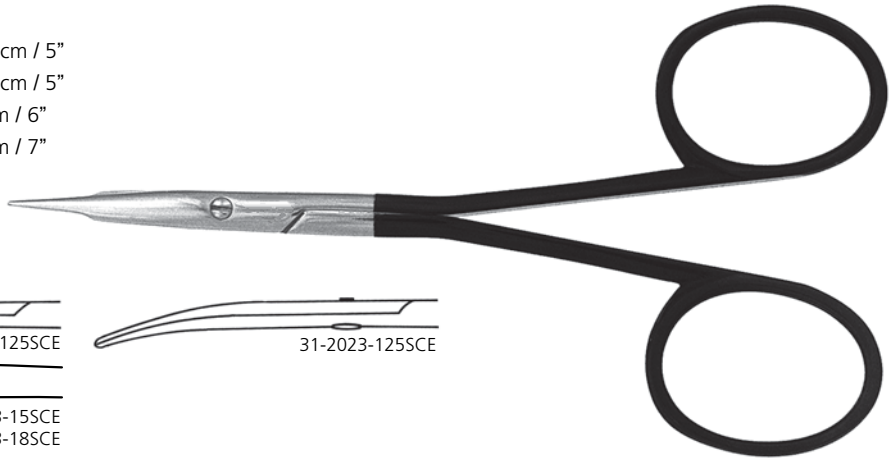
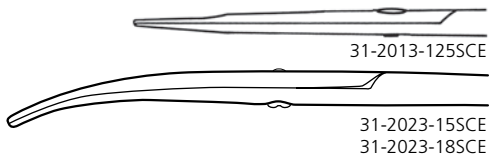

## SHEA

Vein graft scissors with very thin tips to facilitate soft tissue dissection.

* 31-2623-125	Curved	Thin points	12.5 cm / 5"
---------------	--------	-------------	--------------

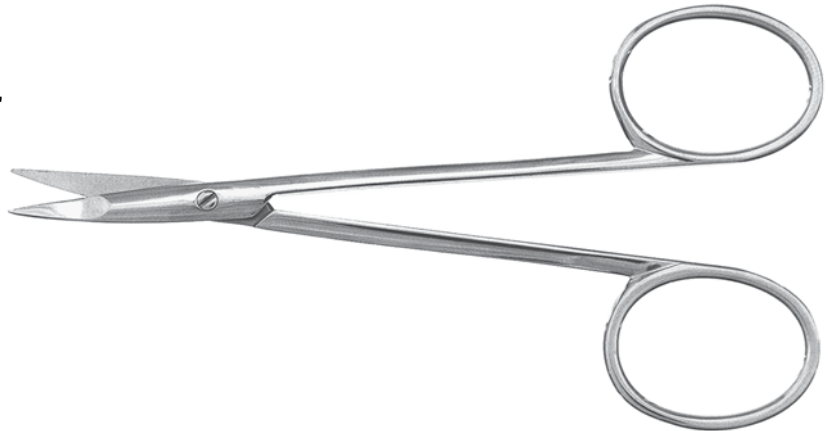

## ZEPF SUPER CUT VASCULAR SCISSORS

Super Cut scissors with angled blades for better reach of vessels etc. Used in vascular surgery.

* 31-2553-18SC	Angled 25	18 cm / 7"
31-2563-18SC	Angled 45	18 cm / 7"
31-2573-18SC	Angled 60	18 cm / 7"
31-2583-17SC	Angled 90	17 cm / 6.75"
31-2593-17SC	Angled 125	17 cm / 6.75"

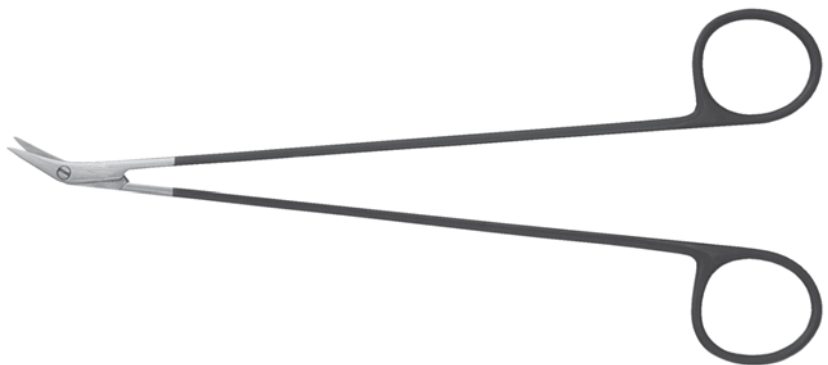
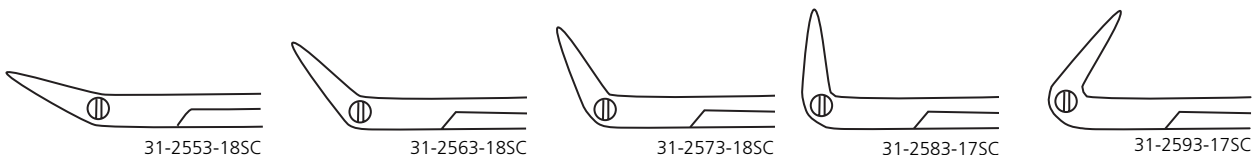

\* Photo shows this instrument

## POTTS-SMITH SUPER CUT

Super Cut scissors with longer blades. Available in three different angles. Used in vascular surgery.

- \* 31-2453-19SC Angled 25 19 cm / 7.5"
- 31-2473-19SC Angled 60 19 cm / 7.5"
- 31-2493-19SC Angled 125 19 cm / 7.5"

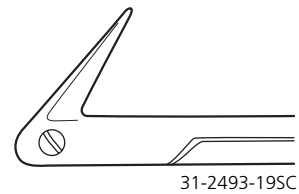
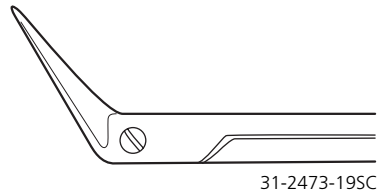
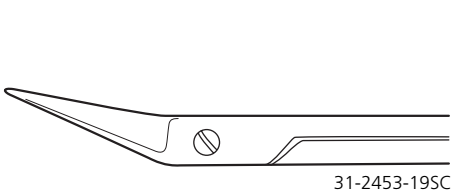
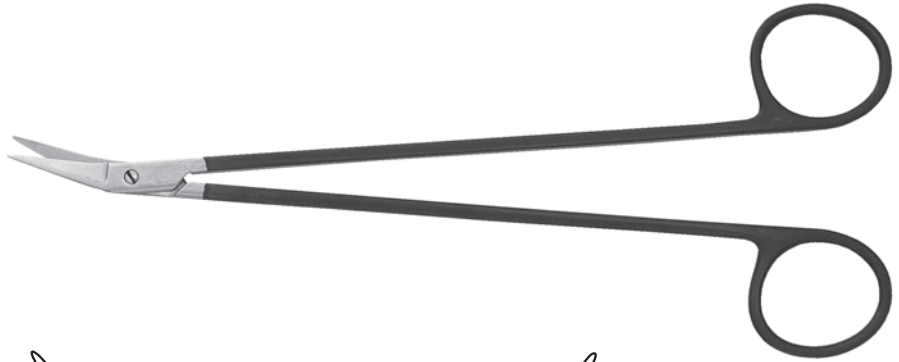

## JOSEPH NASAL

Nasal scissors for the lower lateral cartilage. Useful in dissecting and cutting tough tissue. Beveled blades.

- \* 31-3613-15 Straight Sharp 15 cm / 6"
- 31-3623-15 Curved Sharp 15 cm / 6"



## JOSEPH NASAL SUPER CUT

Super Cut nasal scissors for the lower lateral cartilage. Useful in dissecting and cutting tough tissue. Beveled blades.

- \* 31-3613-15SC Straight Sharp 15 cm / 6"
- 31-3623-15SC Curved Sharp 15 cm / 6"

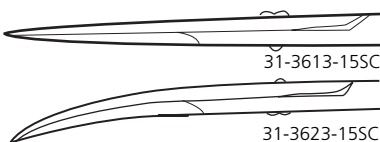

\* Photo shows this instrument

## PECK-JOSEPH

Double-beveled scissors for rhinoplasty

31-3511-15	Straight	Blunt	15 cm / 6"
* 31-3513-15	Straight	Sharp	15 cm / 6"
31-3521-15	Curved	Blunt	15 cm / 6"
31-3523-15	Curved	Sharp	15 cm / 6"

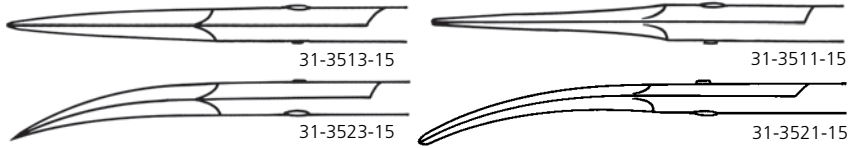
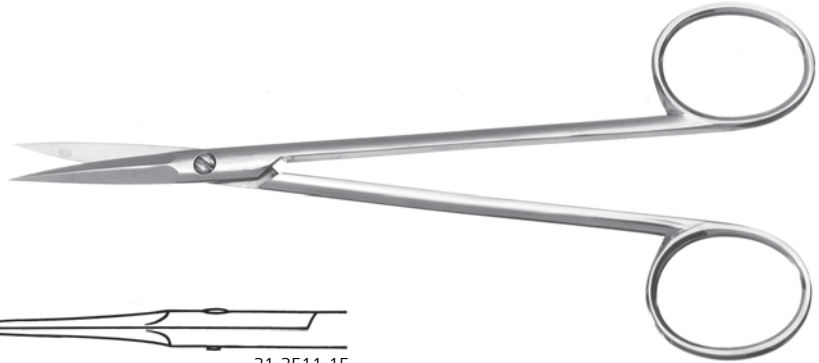

## ZEPF NASAL SUPER CUT

Super Cut nasal scissors for excision of cartilage

* 31-3010-18SC	Straight	Angled Shanks	18 cm / 7"
----------------	----------	---------------	------------

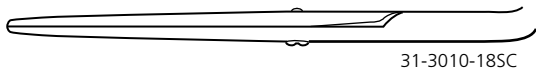

## GORNEY SUPER CUT

Super Cut double-beveled face-lift scissors with flat tips and semi-sharp outer blades. One model with serrated blades to prevent tissue slippage.

31-5611-17SC	Straight	17 cm / 6.75"
* 31-5621-17SC	Curved	17 cm / 6.75"
31-5621-20SC	Curved	20 cm / 8"
31-5624-20SC	Curved Serrated	20 cm / 8"

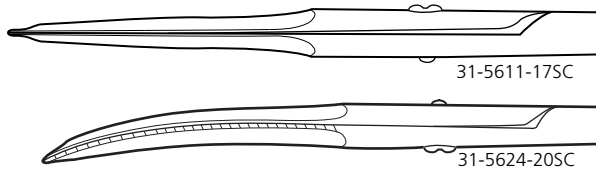
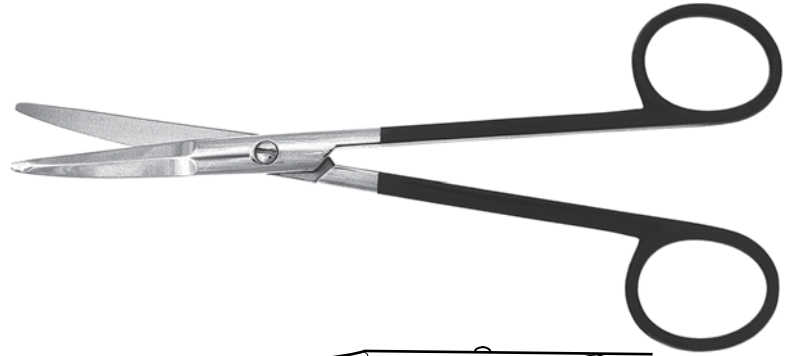

## GORNEY SUPER CUT ERGO

Ergonomic design to avoid fatigue in the hand. One model with serrated blades to prevent tissue slippage. Flat tips and semi-sharp outer blades.

31-5611-17SCE	Straight	17 cm / 6.75"
* 31-5621-17SCE	Curved	17 cm / 6.75"
31-5621-20SCE	Curved	20 cm / 8"
31-5624-20SCE	Curved Serrated	20 cm / 8"

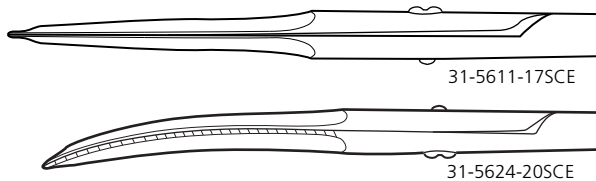
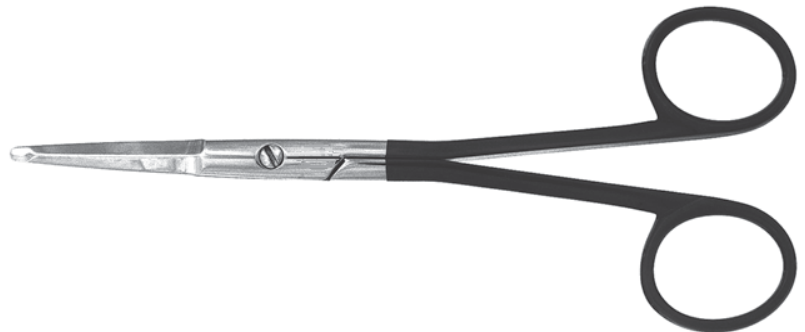

## ASTON SUPER CUT

Super Cut double-beveled face-lift scissors with semi-sharp outer blades for undermining flaps.

* 31-5811-20SC	Straight	20 cm / 8"
31-5821-20SC	Curved	20 cm / 8"

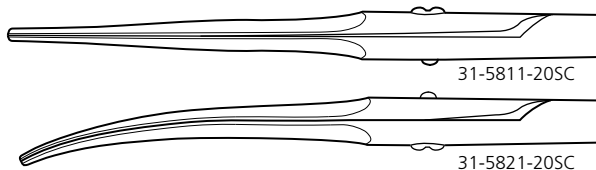
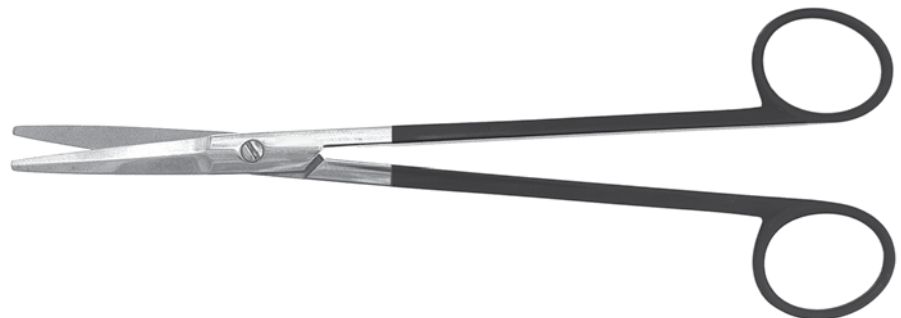

\* Photo shows this instrument



## CASTANARES SUPER CUT

Short sturdy face-lift scissors with very short, beveled blades for separating soft tissue and cutting skin.

\* 31-5911-15SC Straight 15 cm / 6"



## DAVIS SUPER CUT

Super Cut face-lift scissors with tapered blades and sharp tips for precise cutting and dissection.

\* 31-6123-17SC Curved 17 cm / 6.75"



## REES SUPER CUT

Super Cut face-lift scissors, double-beveled with semi-sharp outer blades for undermining skin flaps.

\* 31-5721-17SC Curved 17 cm / 6.75"



## ZEPF SUTURE SCISSORS

Suture removal scissors

\* 31-6321-135 Curved 13.5 cm / 5.25"

