

Distributed by:  
ZEPF SURGICAL  
800-552-3441

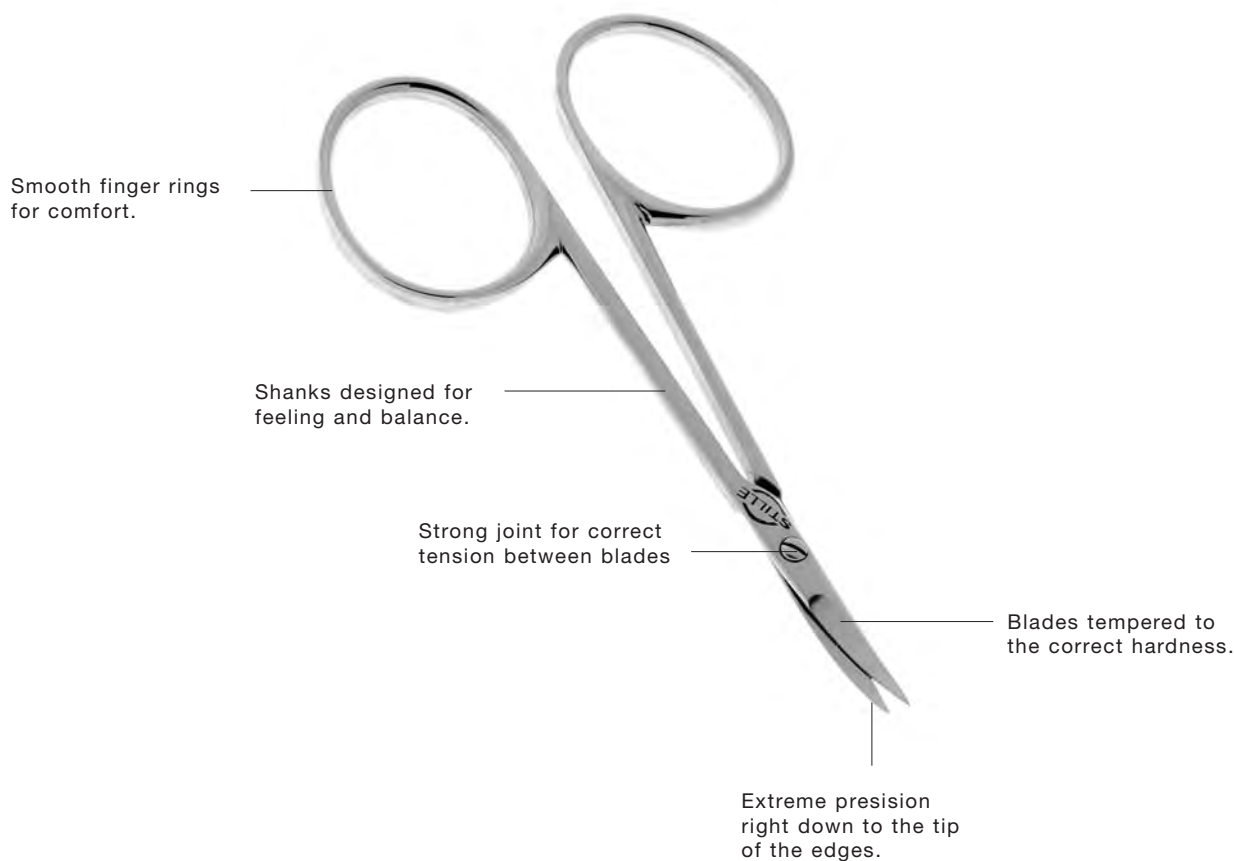

Stille scissors





Stille is world famous for our unique high quality scissors. Stille scissors are extremely light and well balanced. They cut cleanly, not only when new, but also throughout their long life. This is due to careful attention to every part of the instrument during design and production.

Stille scissors offer maximum cutting force for all kinds of soft tissue with a minimum of effort. They are available as ordinary stainless steel scissors, Super Cut scissors and Ergonomic scissors.





## Super Cut Scissors

### What are Super Cut Scissors?

Stille Super Cut Scissors have an unrivaled cutting performance. In addition to incorporating all the advantages of conventional scissors, they are sharper.

### Why are Stille Super Cut Scissors superior to ordinary scissors?

Because they have specially designed cutting edges – one scissors-ground and one knife-ground blade – the scissors actually cut their way through the tissue.

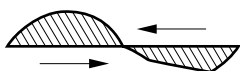

Super Cut edge



Ordinary edge

### What other advantages do Stille Super Cut Scissors offer?

They cut with extreme precision right down to the points of the blades. The special grind makes them suitable both for right-handed and for left-handed surgeons.

### How can you recognize Stille Super Cut Scissors?

The shafts are black-chromed.

### Are Stille Super Cut Scissors all-purpose scissors?

Yes, in the case of tissue, because they cut coarse tissue as efficiently as fine, and with as great precision. Sutures must be avoided as they may damage the fine edges of the scissors. Special Stille scissors are available for cutting sutures.

### Why should you choose Original Stille Super Cut Scissors?

Quite simply because the original is always better than a copy. Stille introduced the world's first Super Cut Scissors 1982. Swedish precision manufacture and the Stille brand name together guarantee that Stille Super Cut Scissors are of the finest conceivable quality.

### Can you sharpen Super Cut Scissors?

Yes, of course. Just like any other scissors, Super Cut Scissors require sharpening occasionally. When it is time for regrinding, Stille's own instrument service department will ensure that the scissors are taken care of with the utmost precision.





## Stille Ergonomic Scissors

Surgical scissors are normally held in a precision grip, involving the thumb and the third or fourth finger. The grip works best when the hand is close to its basic resting position – a position that is the most comfortable. When using traditional scissors, the hand is not held in this position, but rather in a strained, more closed position.

The way to achieve this resting position is to use scissors with a shank design that is slightly different compared to traditional scissors.

The idea behind this new shape is ergonomics. By using ergonomically designed scissors, time consuming procedures can be performed with less strain on the hand. The effect of this is better comfort that enables the surgeon to avoid fatigue in the hand.

Of course the ergonomic scissors have the rest of the features of Stille Super Cut Scissors.

Scissors should only be used for their intended purpose. Do not cut suture, gauze or wire with normal scissors or Super Cut scissors. To maintain the unique cutting performance, Super Cut scissors must be returned to Stille Service for sharpening. Incorrect handling or use of Stille scissors will invalidate the warranty.

### How to test Stille scissors:

- Feel - smooth motion and soft resistance
- Cut - evenly, all the way to the tip
- Listen - no strange sounds
- Look – no visual damages on the blades



### STILLE EYE SCISSORS

Delicate eye scissors with sharp or blunt tips and large finger rings. These are also called iris scissors and are used for nerves, tendons and vessels. They are intended for facial surgery and any type of delicate surgery. Beveled blades.

- \* 101-8001- Straight Sharp 9.5 cm 3.75"
- 101-8002- Straight Blunt 9.5 cm 3.75"
- 101-8003- Curved Sharp 9.5 cm 3.75"
- 101-8004- Curved Blunt 9.5 cm 3.75"

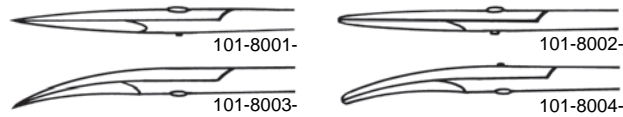

### STILLE EYE SCISSORS

Eye scissors for delicate work. Large finger rings for a comfortable grip. Beveled blades.

- \* 101-8010- Straight Sharp 10 cm 4"
- 101-8011- Straight Blunt 10 cm 4"
- 101-8015- Curved Sharp 10 cm 4"
- 101-8016- Curved Blunt 10 cm 4"

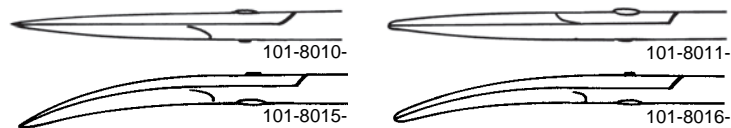

### STILLE SUPER CUT EYE SCISSORS

Super Cut eye scissors with sharp or blunt tips and extremely sharp edges. Beveled blades.

- \* 101-8010-1 Straight Sharp 10 cm 4"
- 101-8011-1 Straight Blunt 10 cm 4"
- 101-8015-1 Curved Sharp 10 cm 4"
- 101-8016-1 Curved Blunt 10 cm 4"

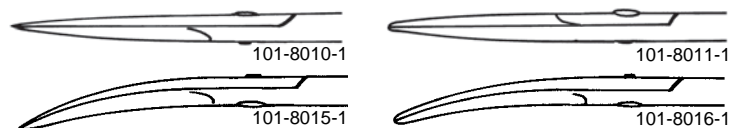

\* Photo shows this instrument

Distributed by:

ZEPF SURGICAL

800-552-3441



**STILLE SUPER CUT BLEPHAROPLASTY**

Short delicate Super Cut scissors suitable for blepharoplasty.

- 101-8018-1 Straight 9.5 cm 3.75"
- \* 101-8019-1 Curved 9.5 cm 3.75"

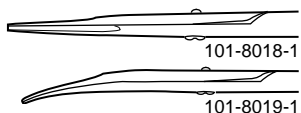

**STILLE ERGO BLEPHAROPLASTY**

Blepharoplasty Super Cut scissors with ergonomically designed shanks for a more relaxed grip.

- \* 101-8019-2 Curved 9.5 cm 3.75"



**RAGNELL SUPER CUT BLEPHAROPLASTY**

Short delicate Super Cut scissors with blunt, flat tips for blepharoplasty.

- \* 101-8030-1 Straight Blunt 9.5 cm 3.75"
- 101-8031-1 Curved Blunt 9.5 cm 3.75"

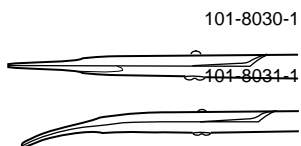

\* Photo shows this instrument

**RAGNELL ERGO BLEPHAROPLASTY**

Blepharoplasty Super Cut scissors with ergonomically designed shanks for a more relaxed grip.

\* 101-8031-2 Curved 9.5 cm 3.75"



**KAYE**

Scissors with serrated blades for "holding" the tissue, making it easier to cut exactly as far as intended.

\* 101-8020- Curved Serrated blunt 10 cm 4"  
 101-8021- Curved Serrated blunt 12.5 cm 5"  
 101-8022- Curved Serrated sharp 12.5 cm 5"

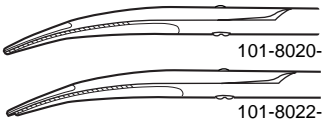

**PECK**

Serrated scissors for excision of upper lateral cartilage.

\* 101-8024- Straight Sharp, serrated 15 cm 6"

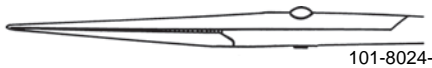

\* Photo shows this instrument

### FOMON

Scissors for rhinoplasty. Double-beveled blades.

\* 101-8025- Curved 12.5 cm 5"



### KAYE

Serrated dissecting scissors.

\* 101-8027- Curved Blunt 18 cm 7"

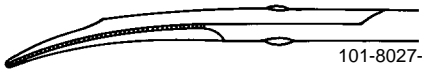

### JABALEY

Sharp scissors suitable for hand surgery, where very strong scissors are used. Beveled blades.

\* 101-8060- Straight Sharp 12.5 cm 5"  
101-8062- Curved Sharp 12.5 cm 5"

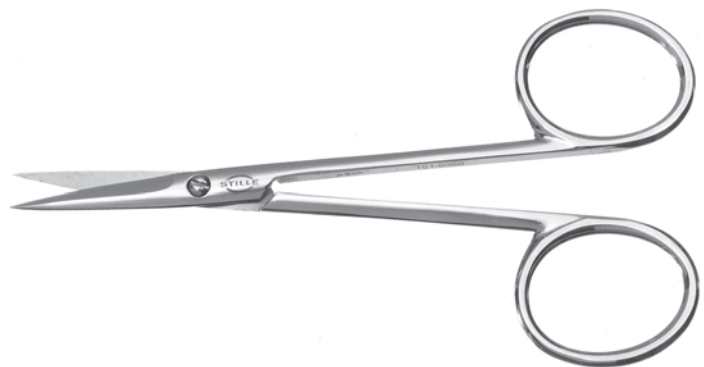
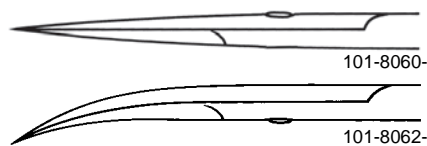

\* Photo shows this instrument



**JABALEY SUPER CUT**

Super Cut scissors for dissection of tough tissue in hand surgery. Beveled blades.

- \* 101-8060-1 Straight Sharp 12.5 cm 5"
- 101-8062-1 Curved Sharp 12.5 cm 5"

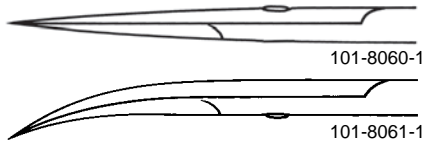

**JABALEY STILLE ERGO**

Ergonomic model to avoid fatigue in the hand. Beveled blades.

- \* 101-8060-2 Straight Sharp 12.5 cm 5"
- 101-8062-2 Curved Sharp 12.5 cm 5"

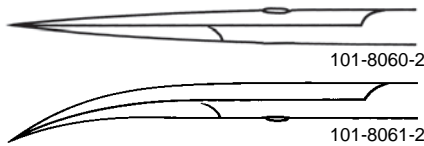

**MAYO-STILLE**

The most used scissors, for all types of surgery. Used for routine dissection and cutting in tissue. Beveled blades.

- 101-8080-15 Straight 15 cm 6"
- 101-8080-17 Straight 17 cm 6.75"
- \* 101-8082-15 Curved 15 cm 6"
- 101-8082-17 Curved 17 cm 6.75"

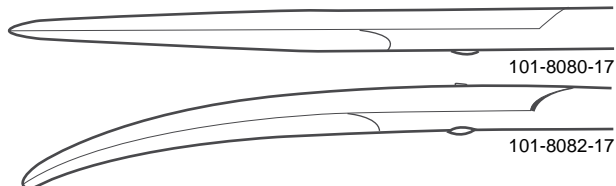
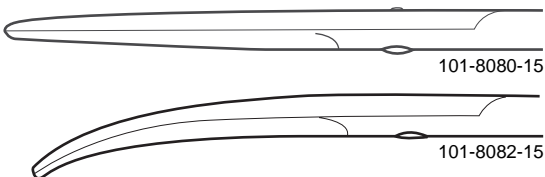

\* Photo shows this instrument

Distributed by:

ZEPF SURGICAL

800-552-3441



**MAYO-STILLE SUPER CUT**

Super Cut dissecting scissors for tough tissue. Beveled blades.

- \* 101-8081-15 Straight 15 cm 6"
- 101-8083-15 Curved 15 cm 6"



101-8081-15



101-8083-15

**STILLE-MAYO**

Sturdy dissecting scissors with rounded blades.

- \* 101-8084-15 Straight 15 cm 6"
- 101-8084-17 Straight 17 cm 6.75"
- 101-8084-19 Straight 19 cm 7.5"
- 101-8086-15 Curved 15 cm 6"
- 101-8086-17 Curved 17 cm 6.75"
- 101-8086-19 Curved 19 cm 7.5"



101-8084-15



101-8084-17



101-8084-19



101-8086-15



101-8086-17

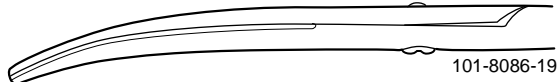

101-8086-19

DISSECTING SCISSORS

\* Photo shows this instrument

**STILLE-MAYO SUPER CUT**

Sturdy Super Cut scissors with rounded blades for dissection of tough tissue.

101-8085-15	Straight	15 cm 6"
101-8085-17	Straight	17 cm 6.75"
101-8085-19	Straight	19 cm 7.5"
101-8087-15	Curved	15 cm 6"
* 101-8087-17	Curved	17 cm 6.75"
101-8087-19	Curved	19 cm 7.5"

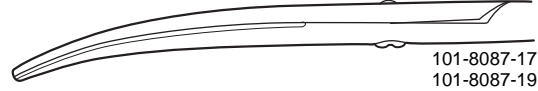
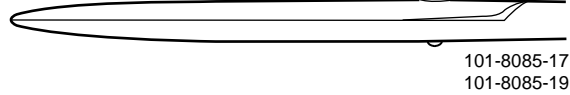
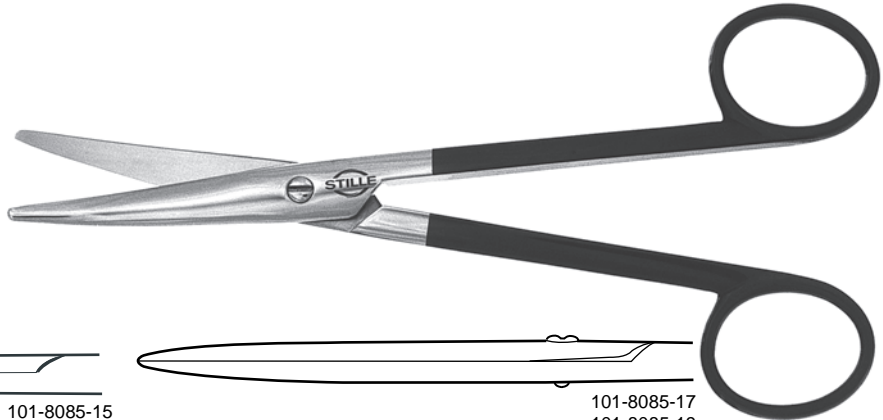

**STILLE-MAYO ERGO**

Ergonomic Super Cut model to avoid fatigue in the hand. Rounded blades. For dissection of tough tissue.

101-8087-152	Curved	15 cm 6"
* 101-8087-172	Curved	17 cm 6.75"



**MAYO-NOBLE**

Short and strong dissecting scissors mainly for orthopaedic surgeons. Beveled blades.

101-8090-	Straight	18 cm 7"
* 101-8092-	Curved	18 cm 7"

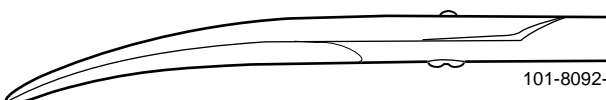
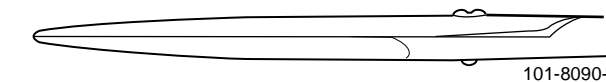

\* Photo shows this instrument

**BABY MAYO**

Delicate version of the regular Mayo scissors. Mainly for plastic- and hand surgery. Beveled blades.

- 101-8100-15 Straight 15 cm 6"
- \* 101-8102-15 Curved 15 cm 6"

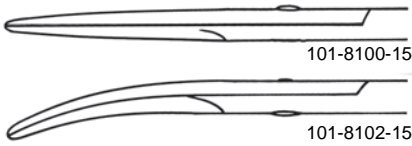

**SIMS**

Mainly used in gynecological and other pelvic surgery. Beveled blades.

- \* 101-8138- Curved 20 cm 8"



**BABY METZENBAUM**

Short, delicate dissecting scissors with rounded blades. Used in delicate surgery requiring small instruments.

- \* 101-8160- Straight Rounded blades 12.5 cm 5"
- 101-8162- Curved Rounded blades 12.5 cm 5"

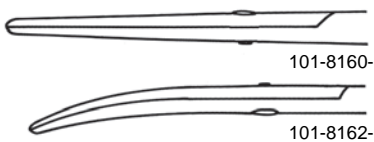

\* Photo shows this instrument

**BABY METZENBAUM SUPER CUT**

Super Cut dissecting scissors for tough tissue. Used in delicate surgery requiring small instruments.

- \* 101-8161- Straight Rounded blades 12.5 cm 5"
- 101-8163- Curved Rounded blades 12.5 cm 5"

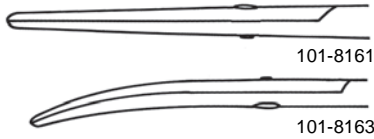

**BABY METZENBAUM ERGO**

Ergonomic model for better control.  
 Rounded blades.

- \* 101-8163-2 Curved 12.5 cm 5"

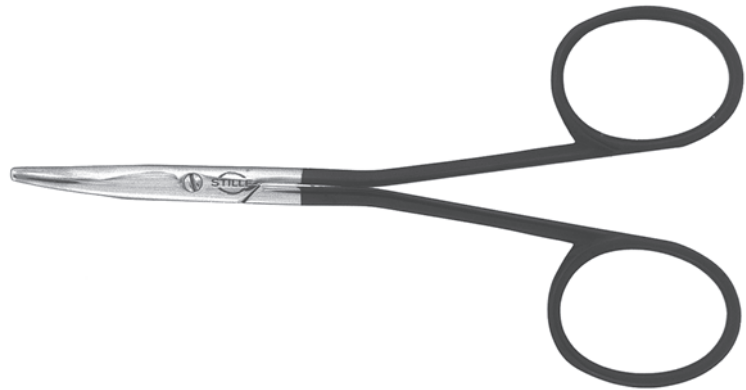

**METZENBAUM DELICATE**

Very delicate version of the popular Metzenbaum dissecting scissors. Rounded blades.

- \* 101-8172-18 Curved 18 cm 7"
- 101-8172-23 Curved 23 cm 9"

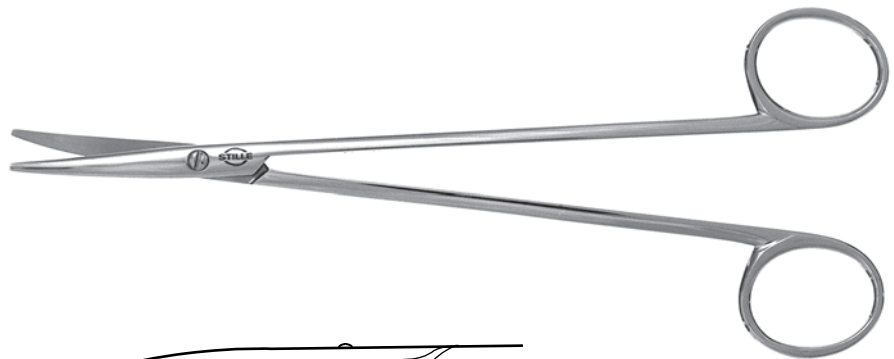
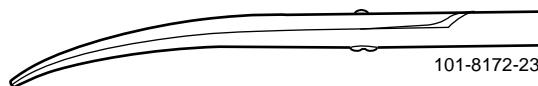
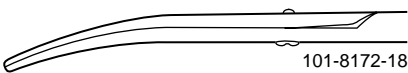

\* Photo shows this instrument

Distributed by:

ZEPF SURGICAL

800-552-3441



**METZENBAUM DELICATE SUPER CUT**

Very delicate version with Super Cut edges and fine rounded tips.

- 101-8173-15 Curved 15 cm 6"
- \* 101-8173-18 Curved 18 cm 7"
- 101-8173-20 Curved 20 cm 8"

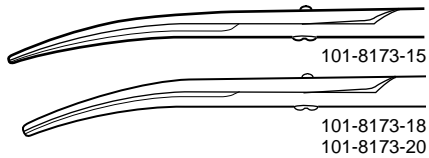
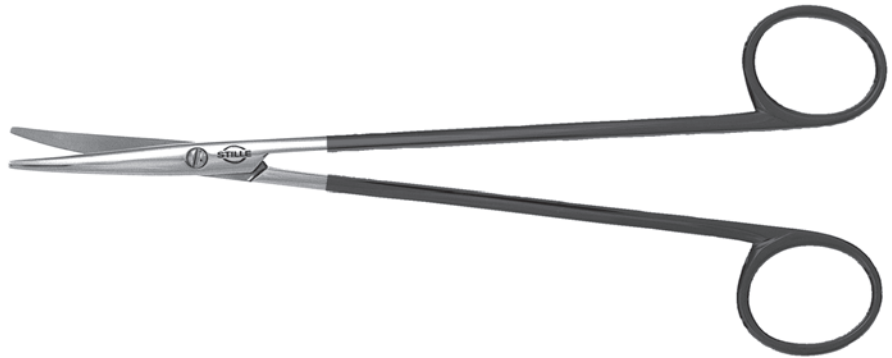

**METZENBAUM**

Dissecting scissors with rounded blades and tips. Used in all specialties for fine dissection. Metzenbaum is one of Stille's most popular scissors model and is available in a variety of shapes and sizes.

- 101-8174-15 Curved 15 cm 6"
- \* 101-8174-18 Curved 18 cm 7"
- 101-8174-20 Curved 20 cm 8"
- 101-8174-23 Curved 23 cm 9"
- 101-8174-26 Curved 26 cm 10.25"

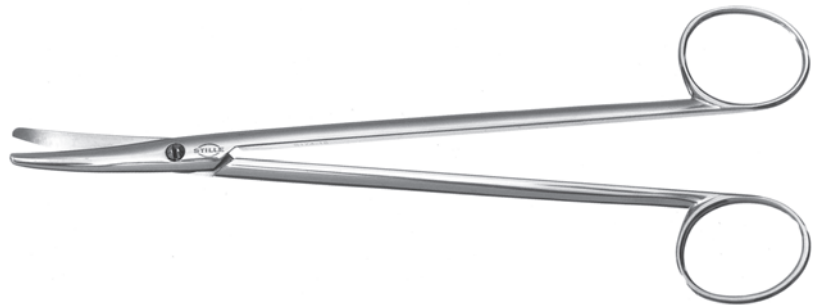

\* Photo shows this instrument



**METZENBAUM SUPER CUT**

The popular Metzenbaum dissecting scissors with Super Cut edges. Rounded/beveled blades.

101-8175-15	Curved	15 cm 6"
101-8175-18	Curved	18 cm 7"
101-8175-20	Curved	20 cm 8"
101-8175-23	Curved	23 cm 9"
101-8175-26	Curved	26 cm 10.25"
101-8175-30	Curved	30 cm 12"
101-8176-15	Straight	15 cm 6"
* 101-8176-18	Straight	18 cm 7"
101-8176-20	Straight	20 cm 8"
101-8176-23	Straight	23 cm 9"
101-8176-26	Straight	26 cm 10.25"

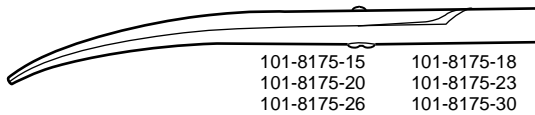
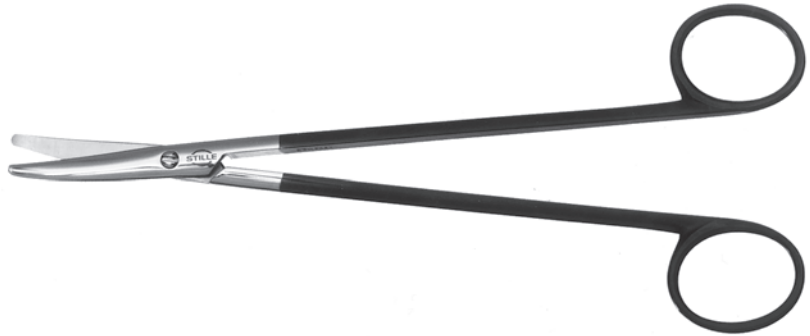

101-8175-15	101-8175-18
101-8175-20	101-8175-23
101-8175-26	101-8175-30

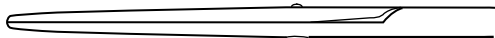

101-8176-15	101-8176-18
101-8176-20	101-8176-23
101-8176-26	

**METZENBAUM STILLE ERGO**

Metzenbaum Super Cut scissors with ergonomically designed shanks for a more comfortable grip. Rounded/beveled blades.

* 101-8175-152	Curved	15 cm 6"
101-8175-182	Curved	18 cm 7"

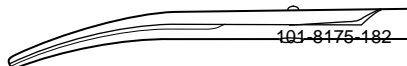
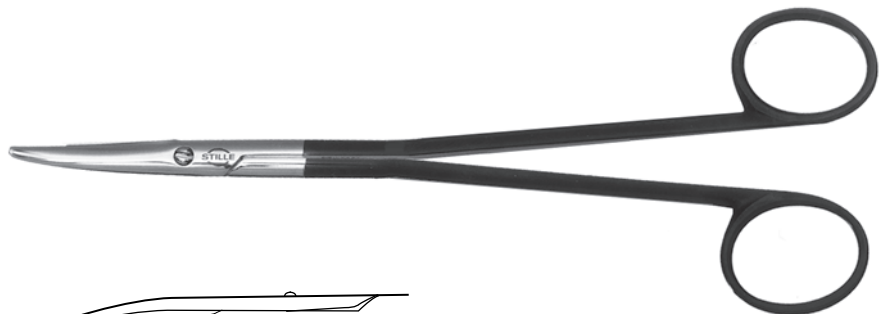

\* Photo shows this instrument

Distributed by:

ZEPF SURGICAL

800-552-3441



**RAGNELL**

Dissecting scissors with flat, rounded tips. Often used in plastic surgery. Is also called Killner by some manufacturers. The short models are used for undermining in plastic surgery and the long models are used for further dissection.

* 101-8378-	Straight	12.5 cm 5"
101-8380-12	Curved	12.5 cm 5"
101-8380-15	Curved	15 cm 6"
101-8380-18	Curved	18 cm 7"
101-8380-20	Curved	20 cm 8"
101-8380-23	Curved	23 cm 9"
101-8382-	Strongly curved	12.5 cm 5"

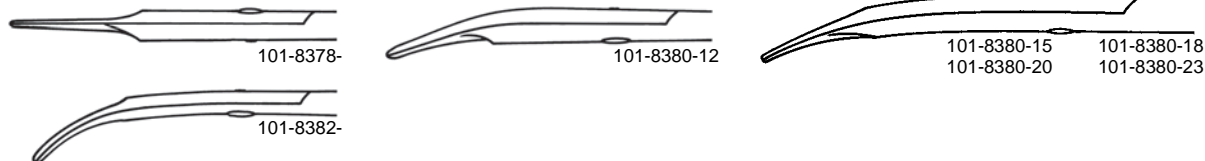
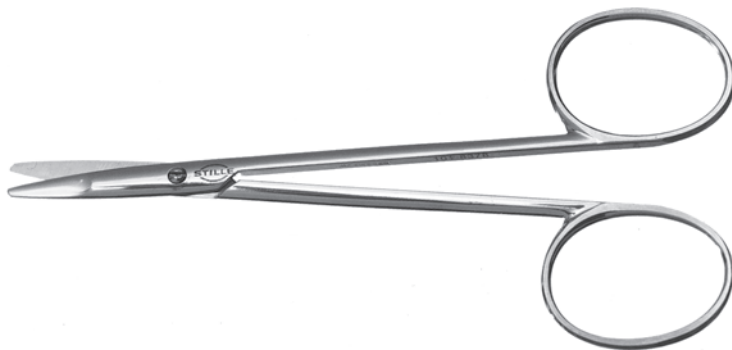

**RAGNELL SUPER CUT**

Super Cut version of the Ragnell scissors. For precise undermining of flaps.

101-8380-121	Curved	12.5 cm 5"
101-8380-151	Curved	15 cm 6"
101-8380-181	Curved	18 cm 7"
* 101-8380-201	Curved	20 cm 8"
101-8380-231	Curved	23 cm 9"

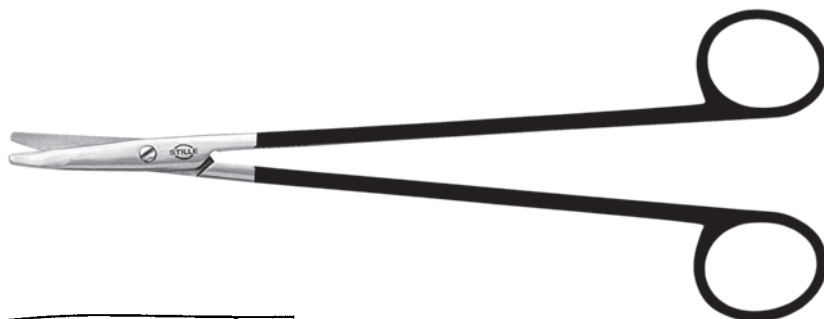

**RAGNELL ERGO**

Ergo Super Cut versions of Ragnell scissors for precise undermining of flaps and comfortable grip.

* 101-8380-122	Curved	12.5 cm 5"
101-8380-152	Curved	15 cm 6"

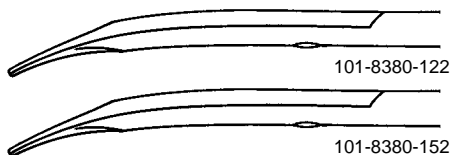

\* Photo shows this instrument

DISSECTING SCISSORS



**THOREK**

Strongly curved dissecting scissors for good visibility. Rounded blades.

\* 101-8470- Strongly curved 21 cm 8.25"

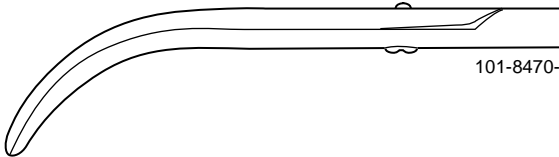

**STILLE-COOPER**

General purpose utility scissors, often used for sutures, gauze etc. Beveled blades.

- \* 101-8042-15 Straight Sharp/blunt 15 cm 6"
- 101-8043-15 Straight Blunt/blunt 15 cm 6"
- 101-8047-13 Curved Sharp/blunt 13.5 cm 5.25"
- 101-8047-15 Curved Sharp/blunt 15 cm 6"
- 101-8048-15 Curved Blunt/blunt 15 cm 6"

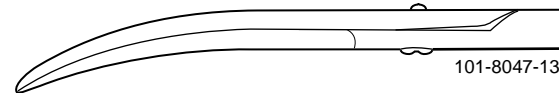
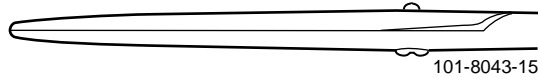

\* Photo shows this instrument

Distributed by:

ZEPF SURGICAL

800-552-3441



**MAYO-HARRINGTON**

Very useful operating scissors for deep surgery like gynecology and thoracic surgery. Beveled blades.

- 101-8096-20 Straight 20 cm 8"
- 101-8096-23 Straight 23 cm 9"
- \* 101-8098-20 Curved 20 cm 8"
- 101-8098-23 Curved 23 cm 9"
- 101-8098-30 Curved 30 cm 12"



101-8096-20  
101-8097-20



101-8096-23  
101-8097-23

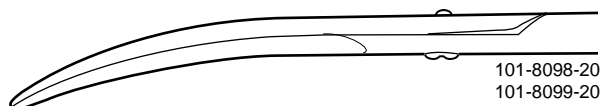

101-8098-20  
101-8099-20



101-8098-23  
101-8099-23

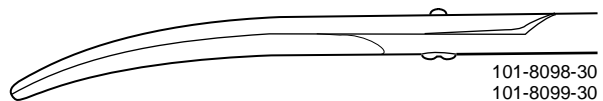

101-8098-30  
101-8099-30

**MAYO-HARRINGTON SUPER CUT**

Operating Super Cut scissors useful for thoracic surgery and gynecology. Beveled blades.

- 101-8097-20 Straight 20 cm 8"
- 101-8097-23 Straight 23 cm 9"
- \* 101-8099-20 Curved 20 cm 8"
- 101-8099-23 Curved 23 cm 9"
- 101-8099-30 Curved 30 cm 12"



Profiles identical to Mayo-Harrington model above.

\* Photo shows this instrument

OPERATING SCISSORS

### BOYD

Scissors with sharp tips and S-shaped shanks for greater visibility. Rounded blades.

\* 101-8420- Curved 17 cm 6.75"

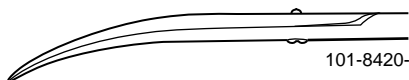

### RAGNELL-STILLE

Mammary plastic scissors intended for breast surgery. Rounded blades.

\* 101-8460- Angled on flat 17 cm 6.75"

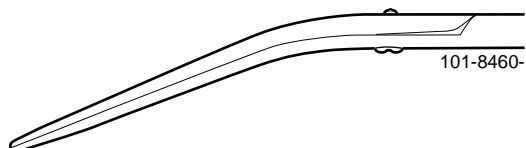

### KÖNIG-STILLE

Nail-splitting scissors, for cutting up ingrown nails. Beveled blades.

\* 101-8580- Straight 15 cm 6"

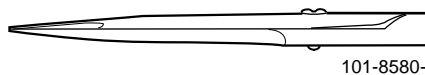

\* Photo shows this instrument

Distributed by:  
**ZEPF SURGICAL**  
 800-552-3441



**LITTLER**

Suture carrying scissors. Rounded blades.

- \* 101-8164- Curved 12.5 cm 5"

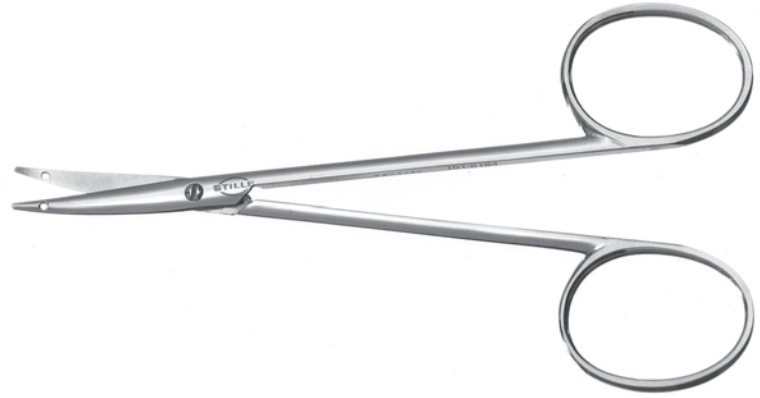

**STEVENS**

Tenotomy scissors with rounded, very thin blades and tapered tips. Used in plastic surgery and hand surgery for cutting with extreme precision in small incisions.

- \* 101-8166- Straight 12.5 cm 5"
- 101-8167- Curved 12.5 cm 5"

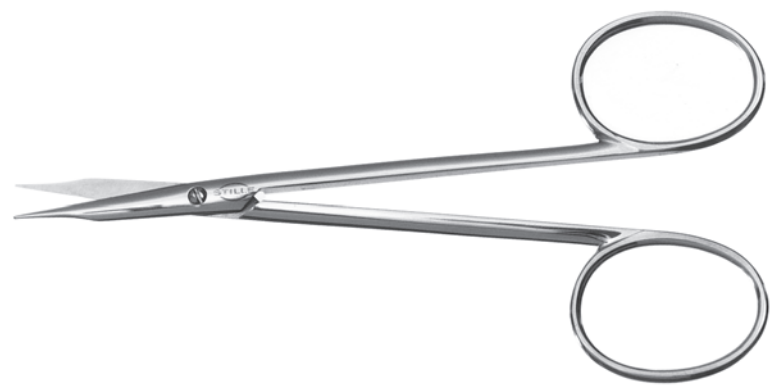
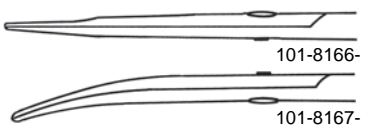

**STEVENS SUPER CUT**

Very popular Super Cut scissors for precise cutting and dissection of fine tissues. Rounded blades.

- \* 101-8166-1 Straight 12.5 cm 5"
- 101-8167-1 Curved 12.5 cm 5"
- 101-8167-151 Curved 15 cm 6"
- 101-8167-181 Curved 18 cm 7"
- 101-8170-1 Straight 9.5 cm 3.75"
- 101-8171-1 Curved 9.5 cm 3.75"

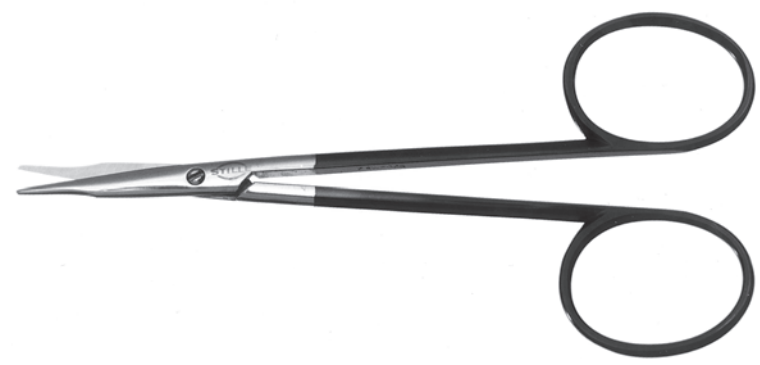
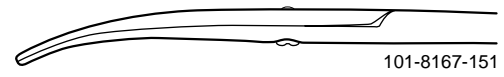
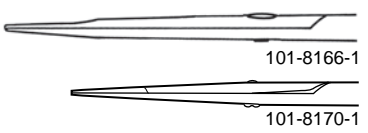

\* Photo shows this instrument

**STEVENS STILLE ERGO**

Ergonomic design of the popular Stevens Super Cut tenotomy scissors.

- \* 101-8166-2    Straight    12.5 cm 5"
- 101-8167-2    Curved     12.5 cm 5"
- 101-8167-152    Curved    15 cm 6"
- 101-8167-182    Curved    18 cm 7"

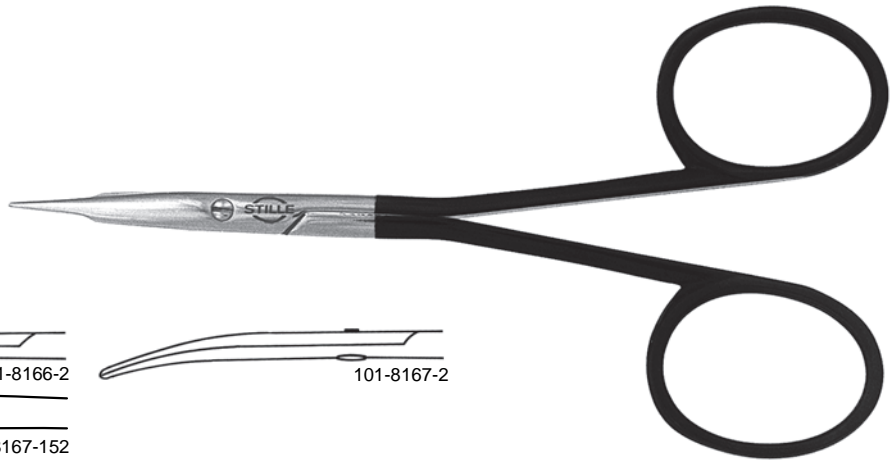
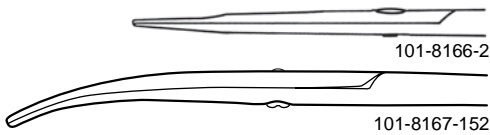

**SHEA**

Vein graft scissors with very thin tips to facilitate soft tissue dissection.

- \* 101-8168-    Curved    Thin points    12.5 cm 5"

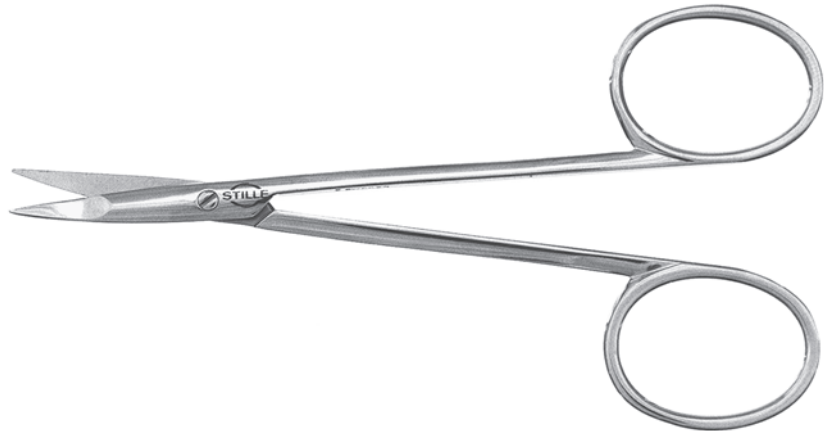

**STILLE SUPER CUT VASCULAR SCISSORS**

Super Cut scissors with angled blades for better reach of vessels etc. Used in vascular surgery.

- \* 101-8200-25    Angled 25    18 cm 7"
- 101-8200-45    Angled 45    18 cm 7"
- 101-8200-60    Angled 60    18 cm 7"
- 101-8200-90    Angled 90    17 cm 6.75"
- 101-8200-125    Angled 125    17 cm 6.75"

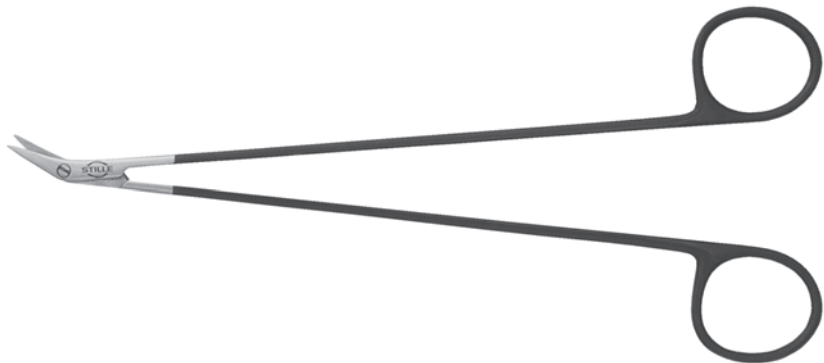
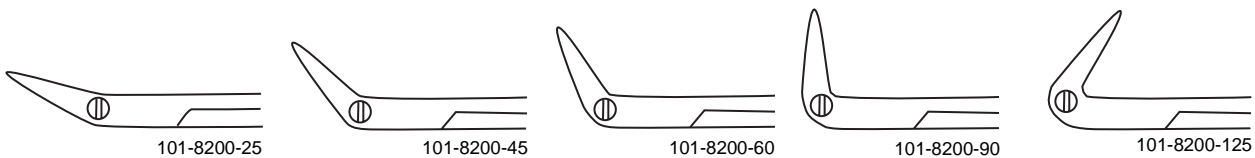

\* Photo shows this instrument

Distributed by:

ZEPF SURGICAL

800-552-3441



**STILLE-POTTS SUPER CUT**

Super Cut scissors with longer blades. Available in three different angles. Used in vascular surgery.

- \* 101-8205-25    Angled 25    19 cm 7.5"
- 101-8205-60    Angled 60    19 cm 7.5"
- 101-8205-125    Angled 125    19 cm 7.5"

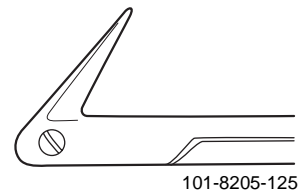
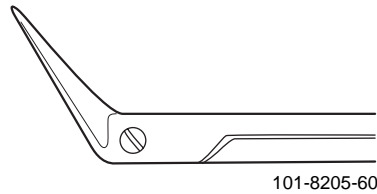
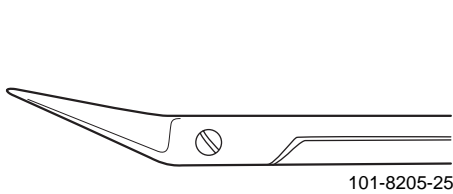
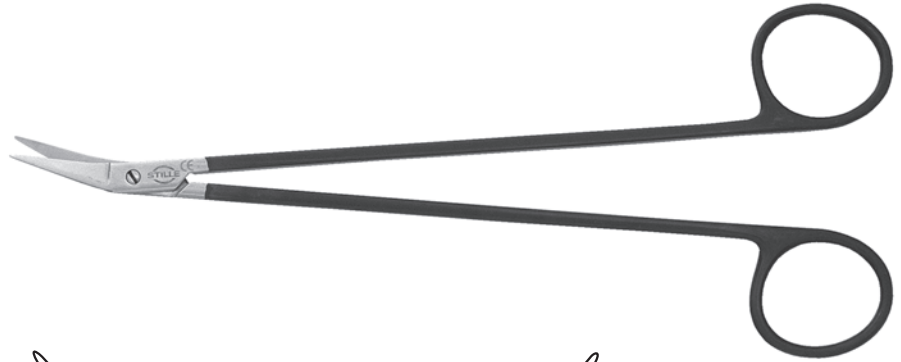

**JOSEPH NASAL**

Nasal scissors for the lower lateral cartilage. Useful in dissecting and cutting tough tissue. Beveled blades.

- \* 101-8110-    Straight    Sharp    15 cm 6"
- 101-8115-    Curved    Sharp    15 cm 6"

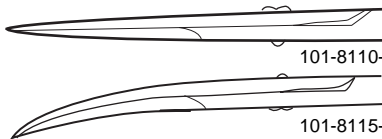

**JOSEPH NASAL SUPER CUT**

Super Cut nasal scissors for the lower lateral cartilage. Useful in dissecting and cutting tough tissue. Beveled blades.

- \* 101-8110-1    Straight    15 cm 6"
- 101-8115-1    Curved    15 cm 6"

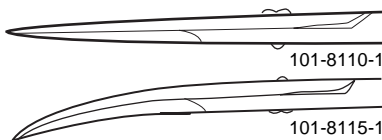

\* Photo shows this instrument

Distributed by:  
**ZEPF SURGICAL**  
800-552-3441



### PECK-JOSEPH

Double-beveled scissors for rhinoplasty.

- \* 101-8120- Straight Sharp 15 cm 6"
- 101-8122- Straight Blunt 15 cm 6"
- 101-8123- Curved Sharp 15 cm 6"
- 101-8125- Curved Blunt 15 cm 6"

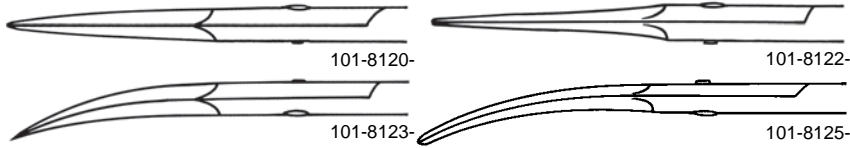
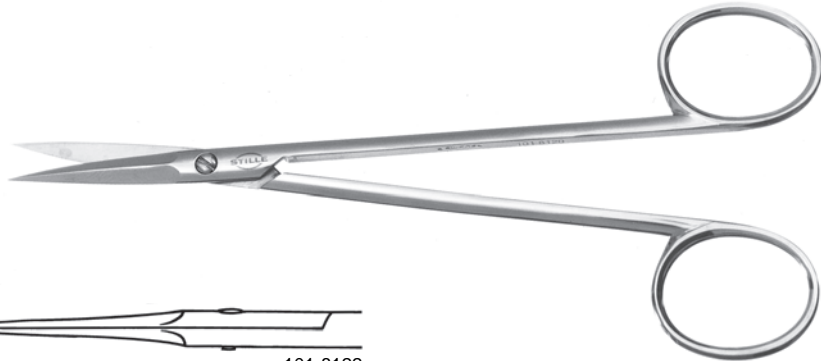

### STILLE NASAL SUPER CUT

Super Cut nasal scissors for excision of cartilage.

- \* 101-8411- Straight Angled shanks 18 cm 7"

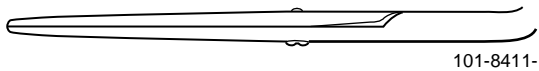

\* Photo shows this instrument

Distributed by:

ZEPF SURGICAL

800-552-3441



### GORNEY SUPER CUT

Super Cut double-beveled face-lift scissors with flat tips and semi-sharp outer blades. One model with serrated blades to prevent tissue slippage.

101-8430-171	Straight		17 cm 6.75"
* 101-8431-171	Curved		17 cm 6.75"
101-8433-20	Curved		20 cm 8"
101-8435-20	Curved	Serrated	20 cm 8"

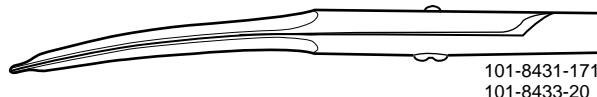
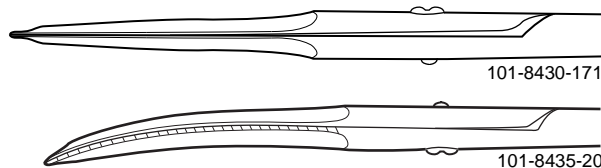

### GORNEY ERGO

Ergonomic design to avoid fatigue in the hand. One model with serrated blades to prevent tissue slippage. Flat tips and semi-sharp outer blades.

* 101-8430-172	Straight		17 cm 6.75"
101-8431-172	Curved		17 cm 6.75"
101-8433-202	Curved		20 cm 8"
101-8435-202	Curved	Serrated	20 cm 8"

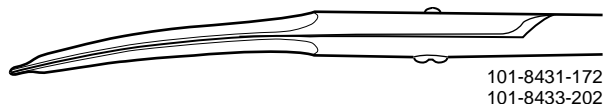
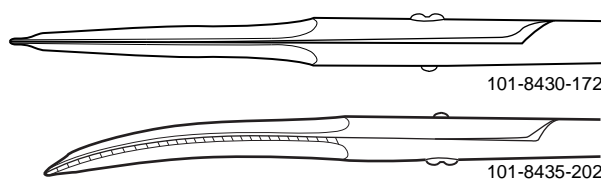

### ASTON SUPER CUT

Super Cut double-beveled face-lift scissors with semi-sharp outer blades for undermining flaps.

* 101-8440-201	Straight	20 cm 8"
101-8441-201	Curved	20 cm 8"

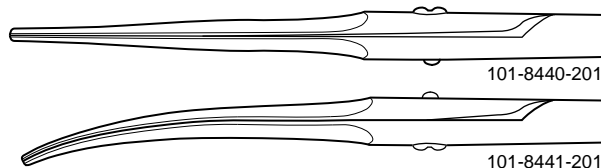

\* Photo shows this instrument



### CASTANARES SUPER CUT

Short sturdy face-lift scissors with very short, beveled blades for separating soft tissue and cutting skin.

\* 101-8450- Straight 15 cm 6"



### DAVIS SUPER CUT

Super Cut face-lift scissors with tapered blades and sharp tips for precise cutting and dissection.

\* 101-8452- Curved 17 cm 6.75"

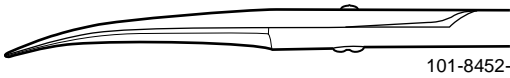

### REES SUPER CUT

Super Cut face-lift scissors, double-beveled with semi-sharp outer blades for undermining skin flaps.

\* 101-8456-171 Curved 17 cm 6.75"



\* Photo shows this instrument

**MATARASSO SUPER CUT**

Super Cut face-lift scissors with double-beveled semi-sharp outer blades.

- 101-8458-17 Curved 17 cm 6.75"
- \* 101-8458-20 Curved 20 cm 8"
- 101-8459-20 Straight 20 cm 8"

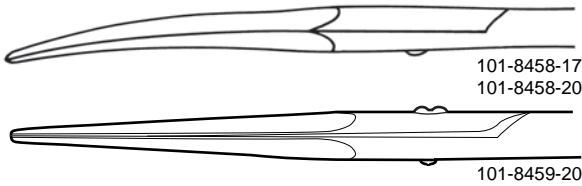

**MATARASSO ERGO**

Ergonomic version of the Matarasso Super Cut face-lift scissors with double-beveled semi-sharp outer blades.

- 101-8458-172 Curved 17 cm 6.75"
- \* 101-8458-202 Curved 20 cm 8"



**STILLE SUTURE SCISSORS**

Suture removal scissors.

- \* 101-8584- Curved 13.5 cm 5.25"

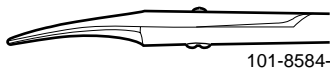

\* Photo shows this instrument