

# COND MOUNTS

US PATENT NO. US11221102B2

## Column Mounting Bracket

INSTALLATION MANUAL

### STEP 1

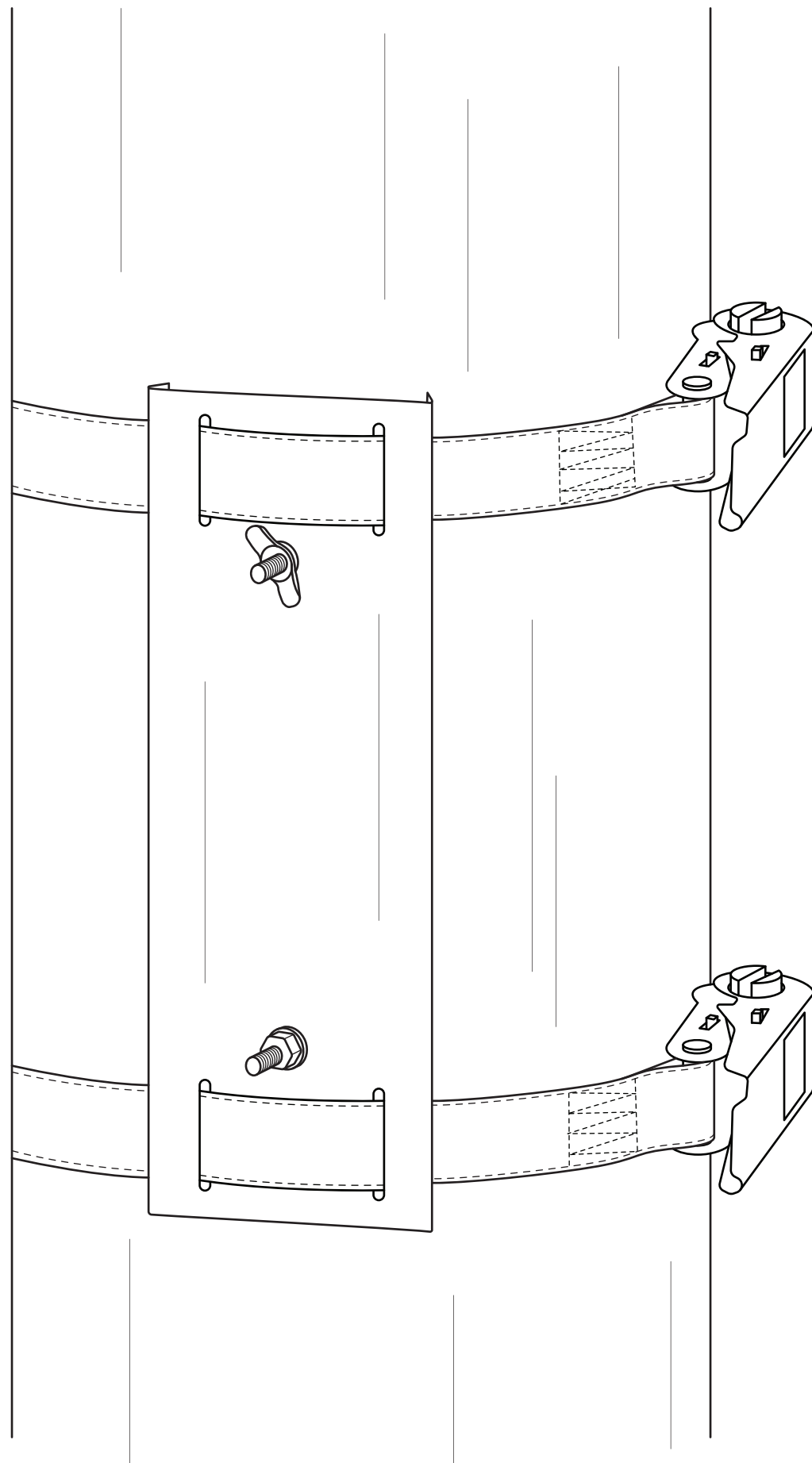

**CLMTVA1144**  
**SMALL COLUMN TV MOUNT**

## OVERVIEW

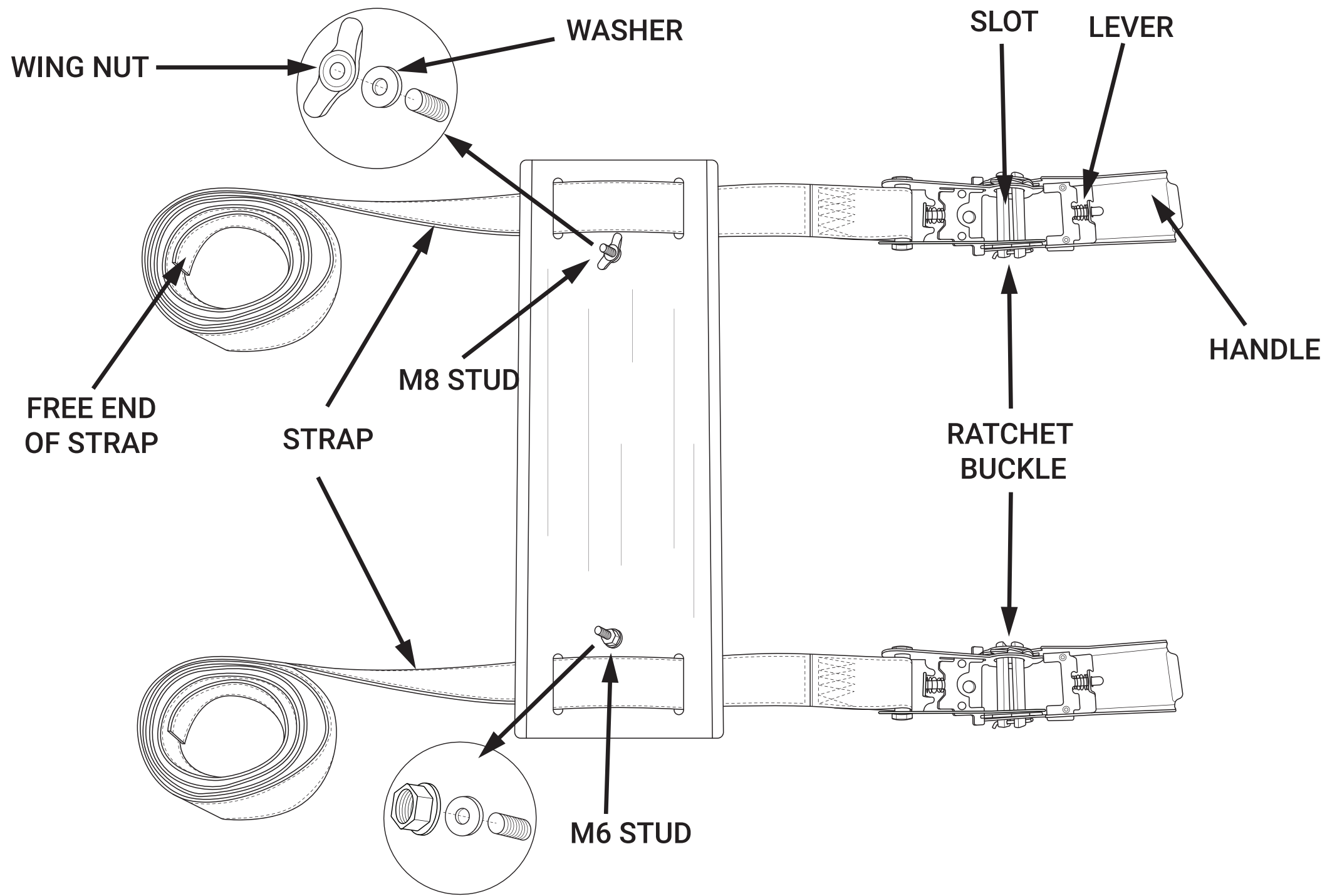

### STEP 01

**TWO PEOPLE ARE REQUIRED TO MOUNT THIS BRACKET**

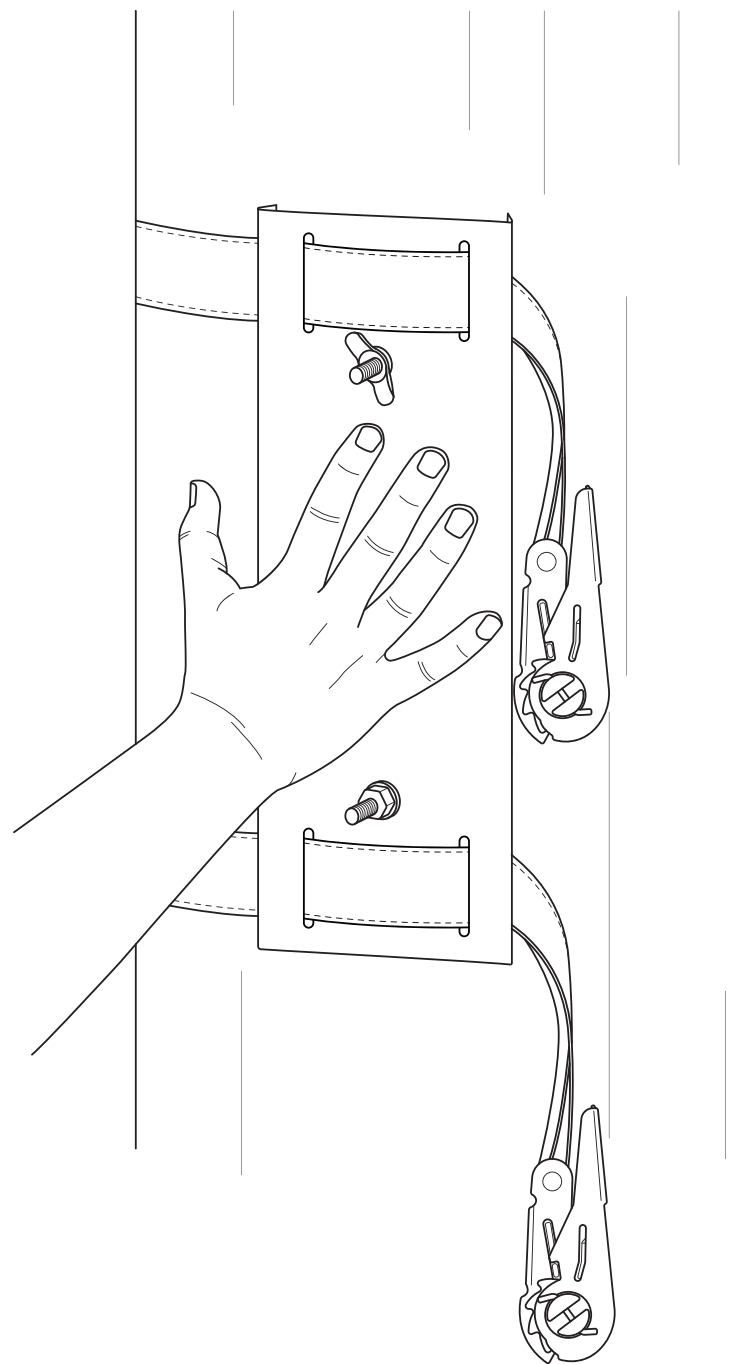

Hold column mounting bracket to the column where you would like to mount the TV.

STEP 02

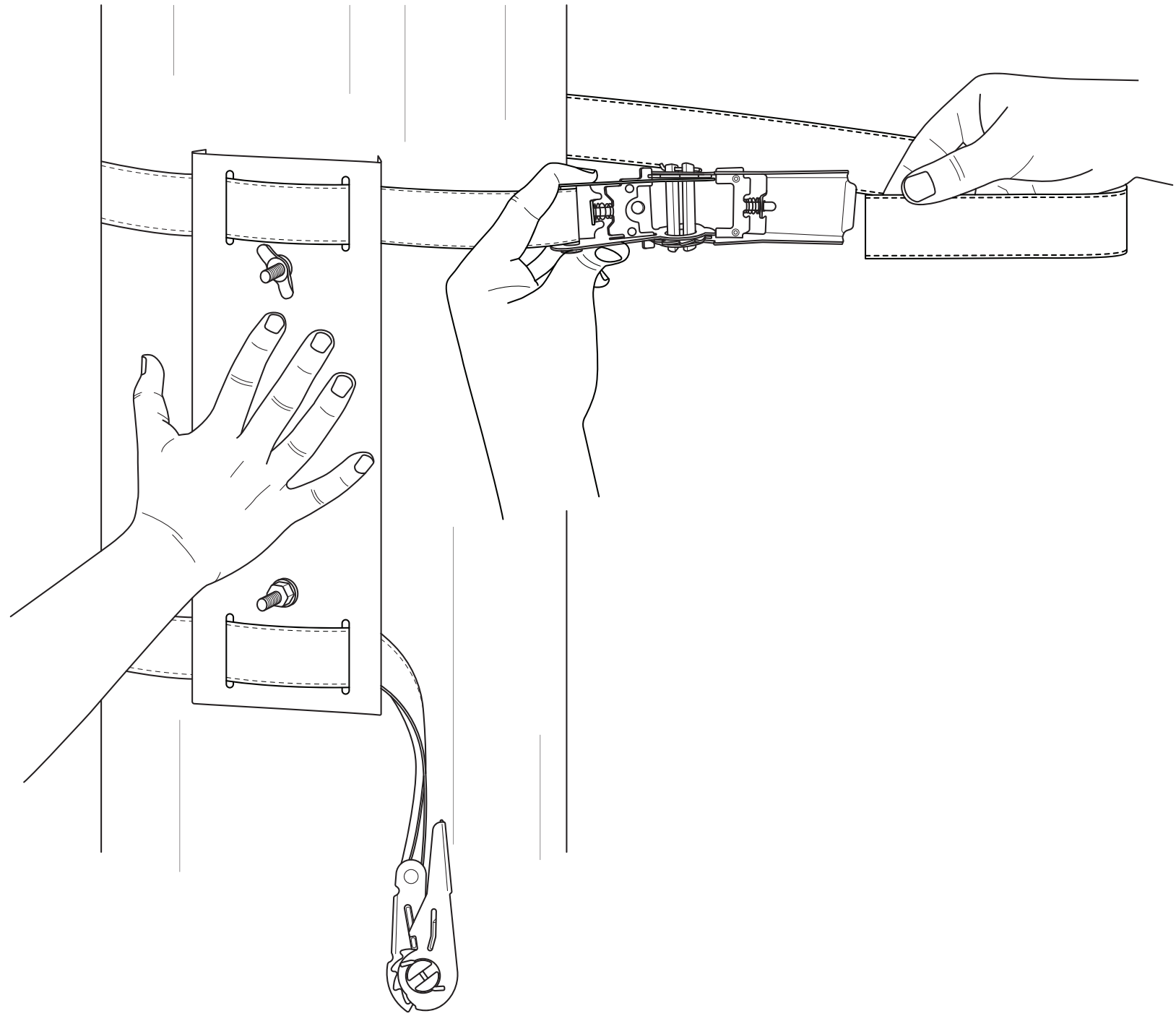

Ask a second person to wrap the strap around the column.

STEP 03

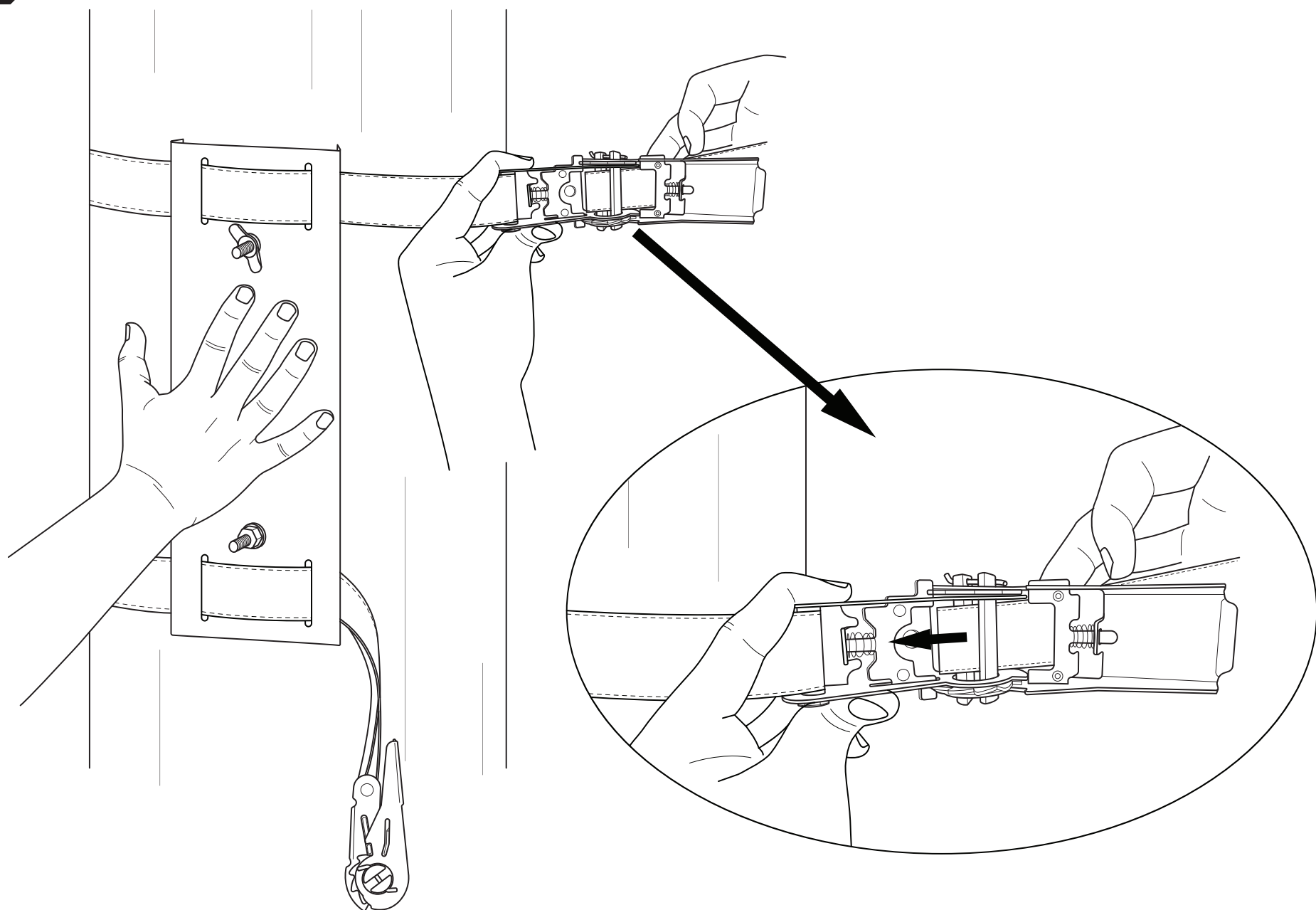

Person #2 should insert free end of strap into the slot of the ratchet buckle.

## STEP 04

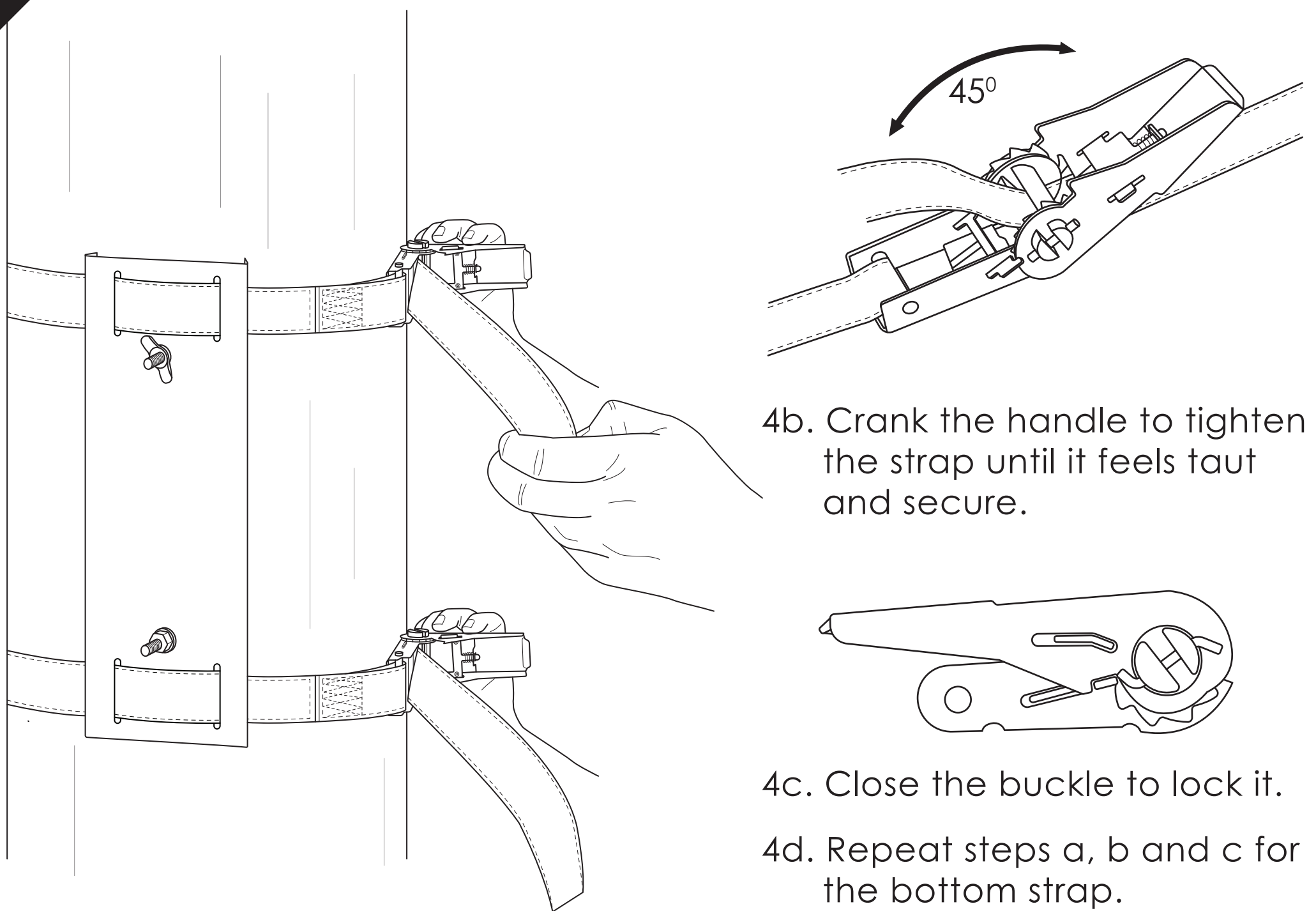

4a. Bring the ratchet buckle snug to the column and pull the strap tight.

4b. Crank the handle to tighten the strap until it feels taut and secure.

4c. Close the buckle to lock it.

4d. Repeat steps a, b and c for the bottom strap.

## STEP 05

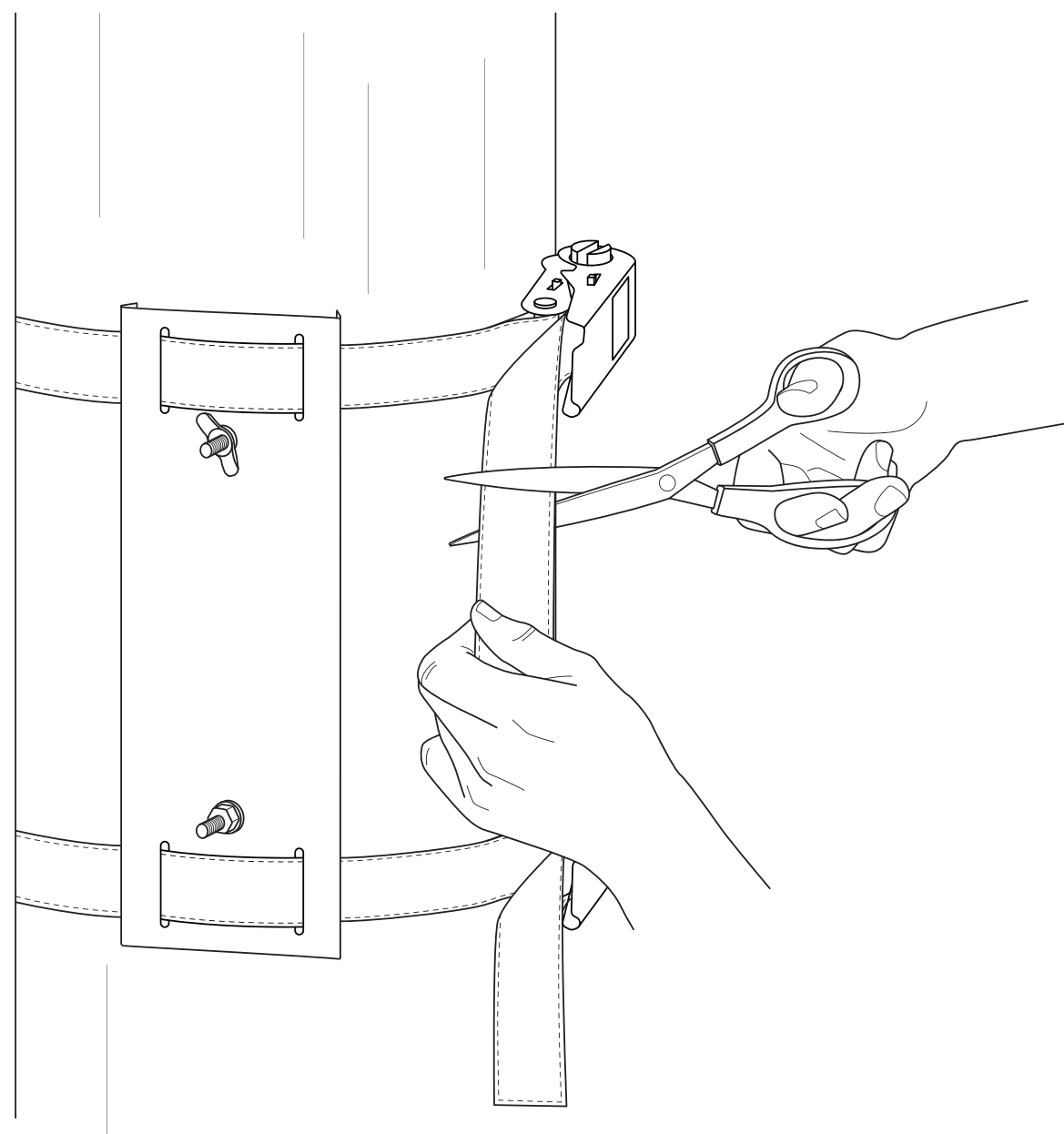

Cut extra strap or fold and tuck away.

Congratulations! - You have finished step 1.  
Next Up : Step 2.

Step 2 - Open box labeled step 2 and follow manual provided.

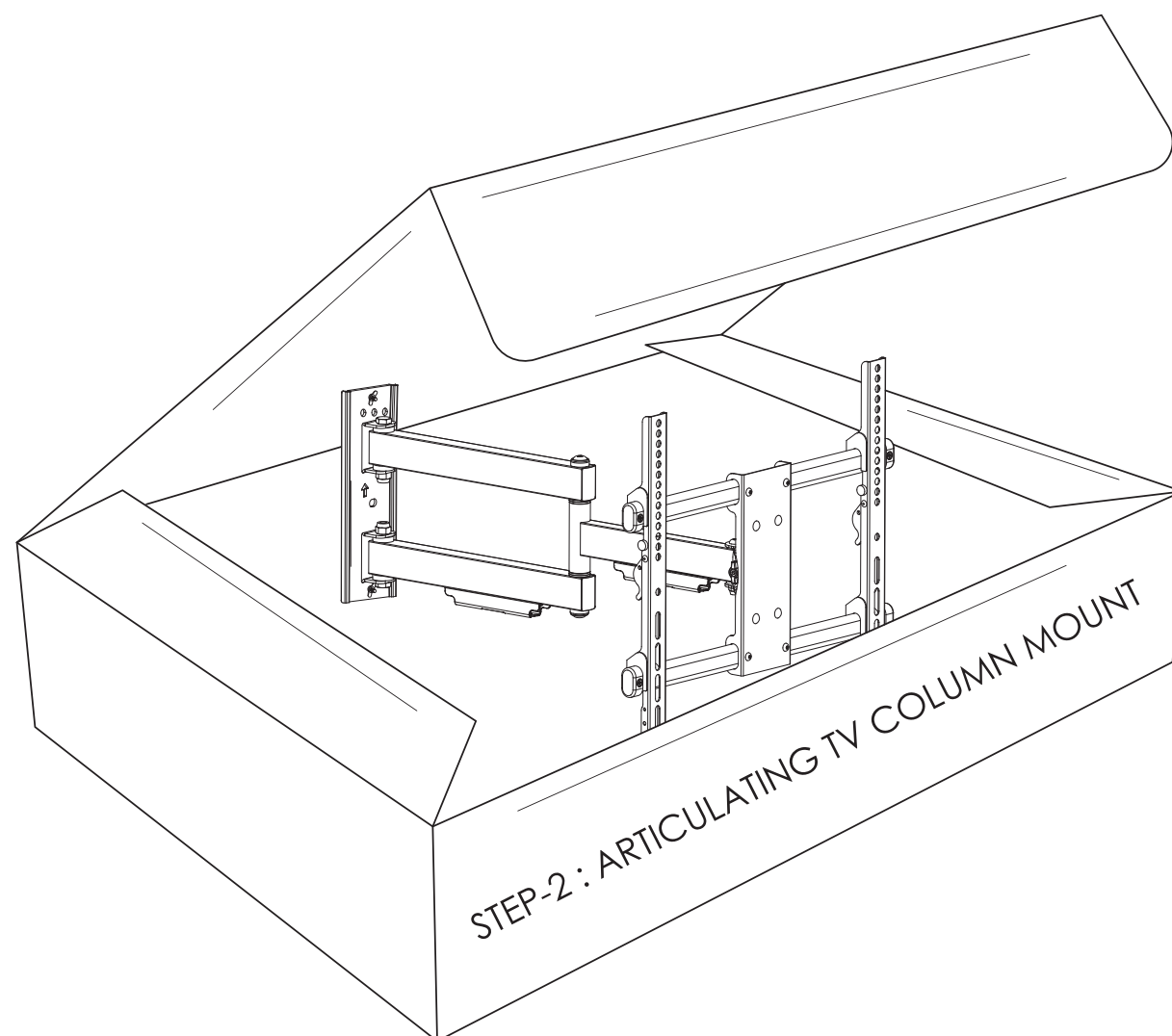

## TO MAKE ADJUSTMENTS AFTER INSTALLATION

TV too high? Too low? Not centered? No problem!

### HOW TO ADJUST THE POSITION OF THE COLUMN MOUNTING BRACKET

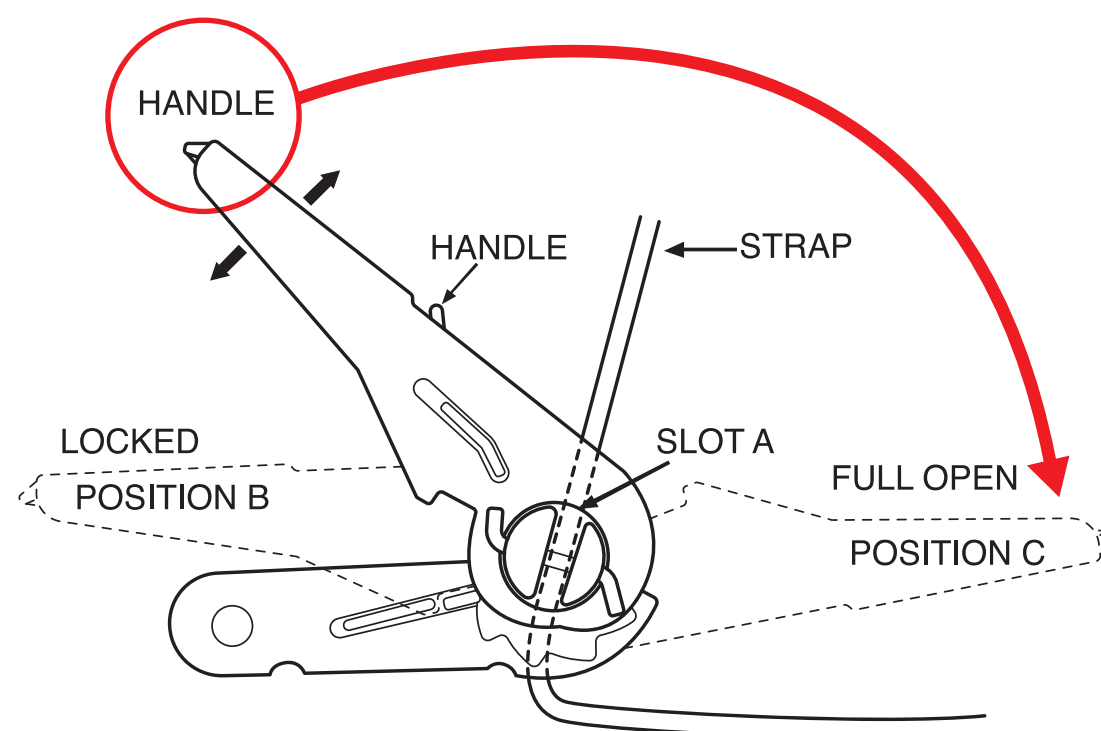

#### CAUTION:

Do not adjust the column mounting bracket while the TV is mounted

- To release the strap pull, and hold the lever towards the handle, then rotate the handle all the way to position C.
- Move your column mounting bracket to the new desired position and tighten.

Need Help? **Contact our pros:**



647-557-5699



support@condomounts.com



condomounts.com