

**Emergent Coils, LLC ~ 855-264-5669**

**P#418/58BS-15X36-10-2WHR-B**

Sales@emergentcoils.com

Tag: Reheat Coil

Qty(1)

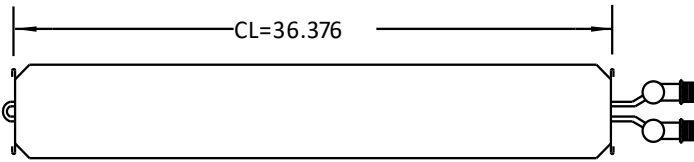

AIR FLOW

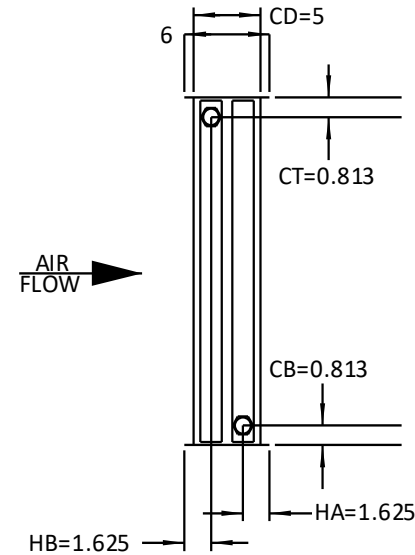
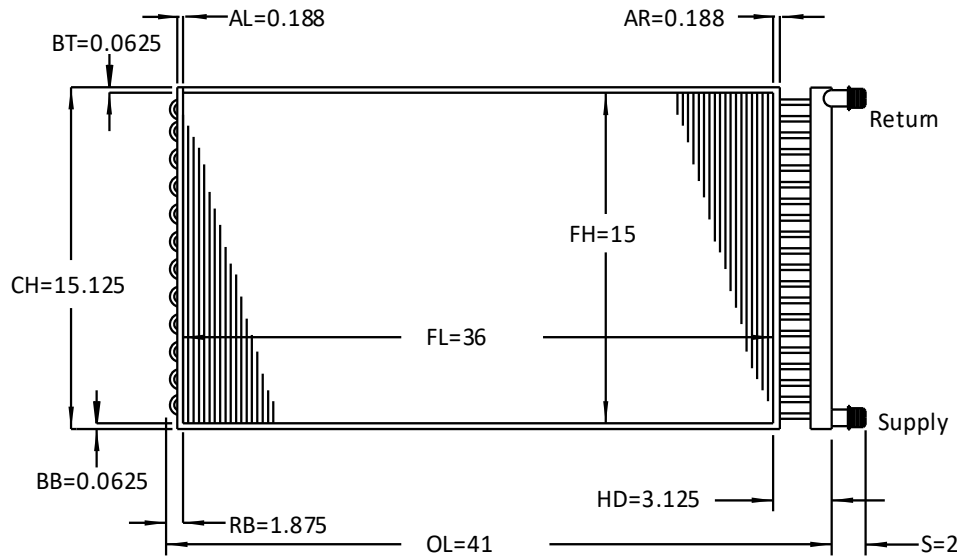

**Fin Type: Waffle**  
**Fin Material: Aluminum**  
**Fin Thickness: .008**  
**Rows/FPI: 2/10**  
**Circuiting: 0**  
**Tube Type: 5/8 Inch / Copper / Smooth**  
**Tube Thickness: 0.020**  
**Casing: Galv Gages: TS=18/ SP=18**

**Connection Material: Copper**  
**Supply Connection Size: 1**  
**Supply Header Dia.: 1.125**  
**Return Connection Size: 1**  
**Return Header Dia.: 1.125**  
**Connection Type: MPT**  
**App. weight (Uncrated each) : 33.3**

**Approximate Fluid Volume (Gal) : 1.0**  
**Tube Sheet Flange Standard**  
**Side Plate Flange: Stacking**