

HOW THE SOLAR POWERED LIGHT WORKS

In the daytime the light will automatically turn off and begin to charge the battery.

The solar panel has a photosensor to detect light. At night, the light automatically turns on using the power stored (you also can cover the solar panel with your hand to simulate night made.)

WARNING & NOTICE

- Do not look directly at the LED light, or it may damage your eyes.
- Do not attempt to disassemble or remodel the product. Any changes can be dangerous and will void the warranty.
- Keep the product away from flammable items, or explosion or injuries may occur.
- Switch OFF the product when it is not in use for a long period of time.

PRODUCT SPECIFICATION

Material	ABS / Resin	Solar Panel	4.52 X 2.95 inches / 1.5W
Solar Box Size	4.72*3.15*8.46 inches	Waterproof Performance	IP65
Spot Light Size	3.78*2.36*8.03 inches	Accessories	1* Solar Box 1* Spot Light 1* Unit 1* User manual
Unit Size	7.0*6.0*15.0 inches		

This product has a 1-year limited warranty. For further information, please visit our website at www.techkogroup.com

Copyright Reserved

☎ 1-888-883-2456

✉ support@techkogroup.com

Solar Spotlight

USER MANUAL

TECHKO®

Model: SG-805

- ◆ Carefully read this manual before using the product.
- ◆ Keep the manual with you for reference as needed.

PLEASE FULLY CHARGE THE PRODUCT BEFORE USING

- Remove the protective film over the solar panel before use.
- Do not charge the solar light indoors or any place where direct sunlight cannot reach the solar panel. Otherwise, the product will not charge properly.
- Charging time may vary depending on weather, temperature, and seasons.
- Please keep the solar panel clean to make sure the product can properly charge.
- Frequently clean solar panel as needed. Avoid scratching on the panel or it may lower charging efficiency.
- Ensure that the soil where the spike is to be placed is soft enough to insert to prevent any damage to the spike/pole when installing.
- This can be done by adding water to the soil to help soften the installation site or gently breaking up soil with a tool before installation.

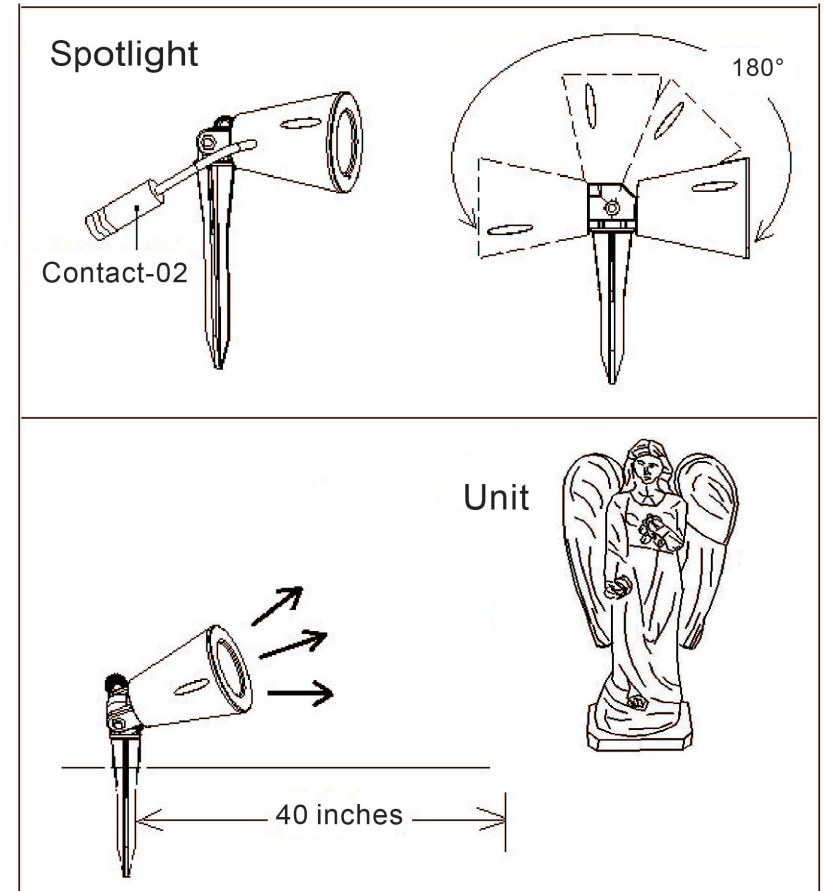
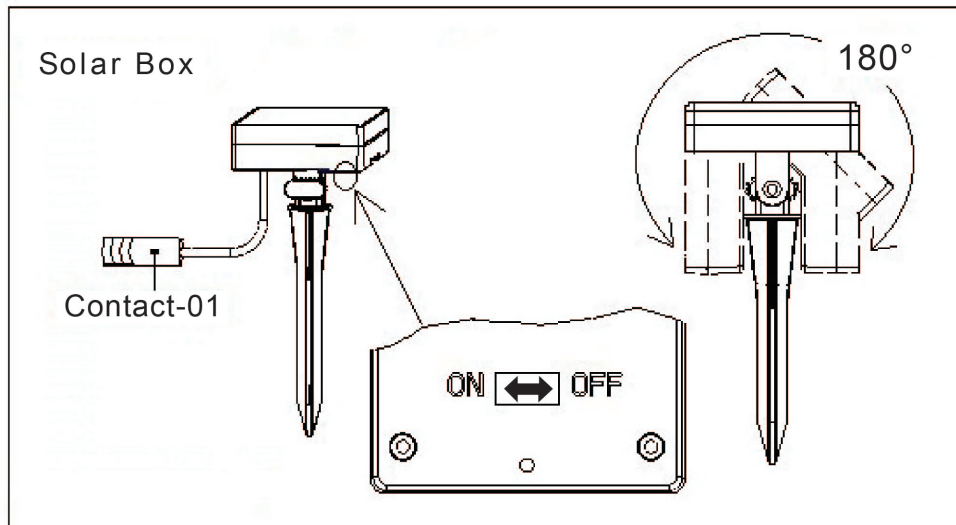

How to Operate

- Adjust the solar panel and light using the adjustable knobs for optimal positioning.
- Connect Contact-01 to Contact-02. Secure the cover from Contact-01 by twisting the cover onto Contact-02.
- Slide the ON/OFF switch located behind the solar panel to the left to turn the unit to the ON position.
- Slide the ON/OFF switch located behind the solar panel to the right to turn the unit to the OFF position.
- Adjust the distance between of unit and spot light. (approximate 40 inches), to shine the unit.