

WiFi & RF 3 Channel High Voltage LED Strip Controller

Model No.: S3(WT)

Features

- 3 channel high voltage LED strip controller, can control maximum about 50 meters of high voltage LED strip, different LED strip may have difference.
- 3 in 1 function, used for control RGB, color temperature or single color LED strip.
- Tuya APP cloud control, support on/off, RGB color, color temperature and brightness adjust, delay turn on/off light, timer run, scene edit and music play function.
- Voice control, support for Amazon Alexa, Google Assistant, Tmall Genie and Xiaodu smart speakers.
- Match with RF 2.4G remote control optional.
- User need set light type by press key before Tuya APP network connection and match RF remote of the same light type.
- Each S3(WT) controller can also work as WiFi-RF converter, then use Tuya APP to control one or more RF LED controller or RF LED dimming driver synchronously.
- Light on/off fade time 3s selectable.
- Connect with external push key to achieve on/off and 0-100% dimming function.

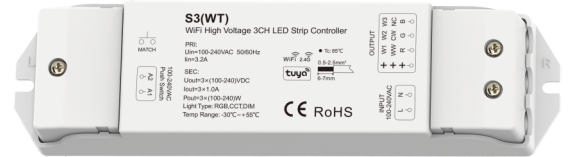

CE RoHS EMC LVD RED

Technical Parameters

Input and Output		Safety and EMC		Dimming data	
Input voltage	100-240VAC	EMC standard (EMC)	ETSI EN 301 489-1 V2.2.3	Input signal	Tuya APP + RF 2.4GHz + Push Dim
Input current	3.2A	EMC standard (EMC)	ETSI EN 301 489-17 V3.2.4	Dimming gray scale	4096 (2 ¹²) levels
Output voltage	3 x (100-240)VDC	Safety standard(LVD)	EN 62368-1:2020+A11:2020	Dimming range	0-100%
Output current	3CH,1A/CH	Radio Equipment(REL)	ETSI EN 300 328 V2.2.2	PWM Frequency	2kHz
Output power	3 x (100-240)W	Certification	CE,EMC,LVD,RED	Package	
Environment		Warranty		Size	L178x W150 x H38mm
Operation temperature	Ta: -30°C ~ +55°C	Warranty	5 years	Gross weight	0.136kg
Case temperature (Max.)	Ta: +85°C				

Mechanical Structures and Installations

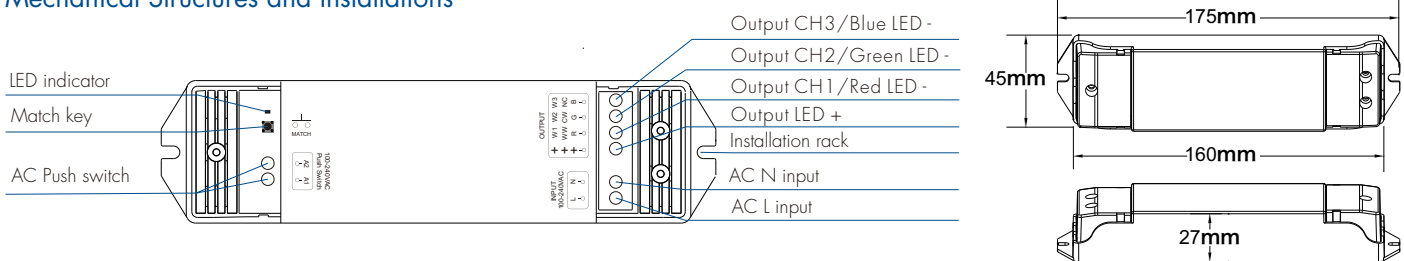

System wiring

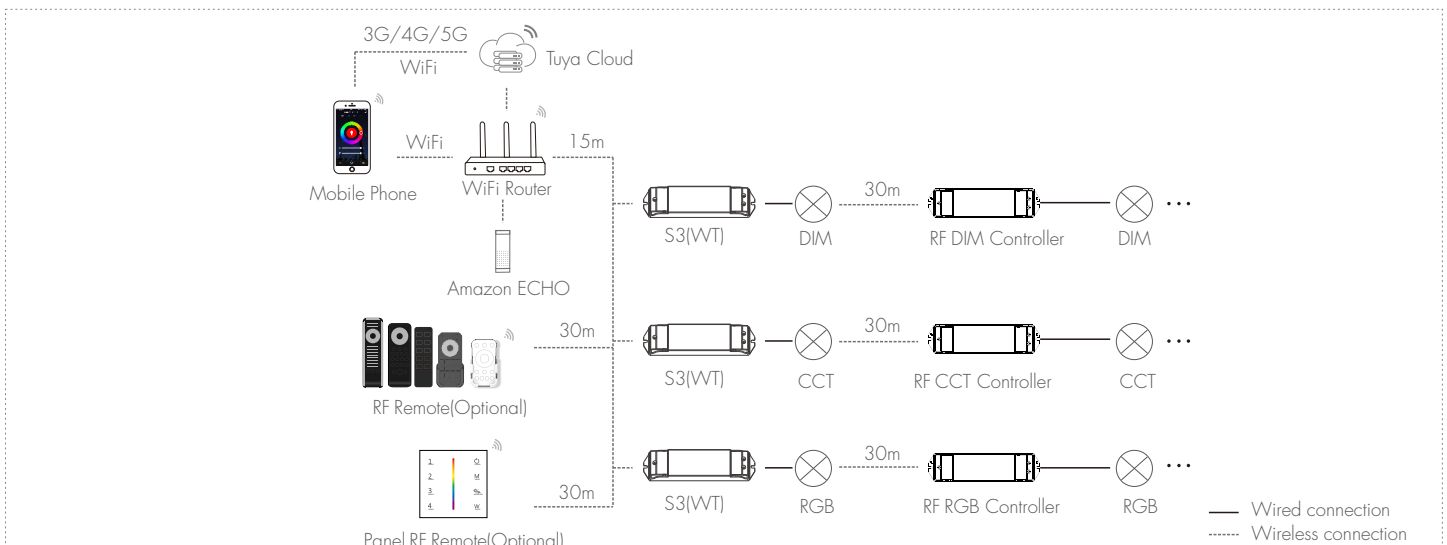

Wiring Diagram

Caution: This controller apply for high voltage LED strip, please carefully ensure all wire connections and polarities are correct and secure before applying power, otherwise this controller or high voltage LED strip will be damaged.

• S3(WT) for RGB

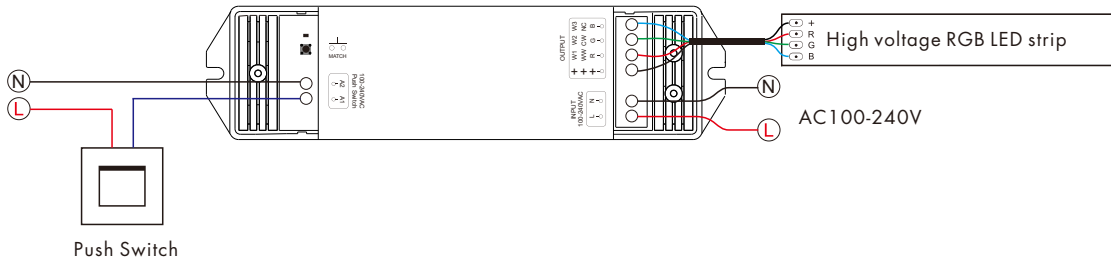

Press and hold match/set key for 12s, until the RUN LED indicator turn red, then release, the controller will become RGB type, then do smart config by tuya APP, or short press match key to match with RGB RF remote.

• S3(WT) for dual color

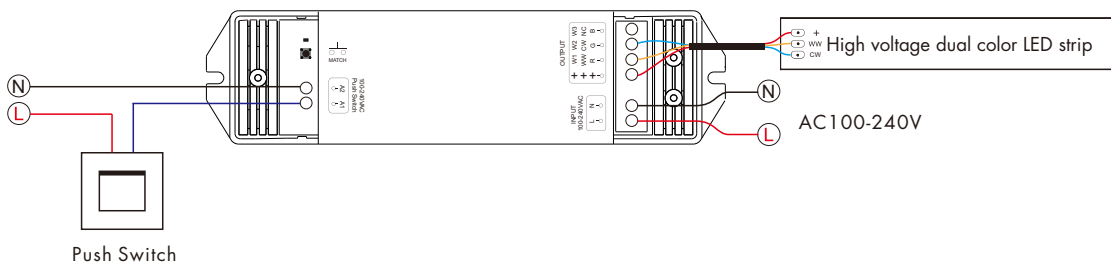

Press and hold match/set key for 10s, until the RUN LED indicator turn yellow, then release, the controller will become CCT type, then do smart config by tuya APP, or short press match key to match with CCT RF remote.

• S3(WT) for single color

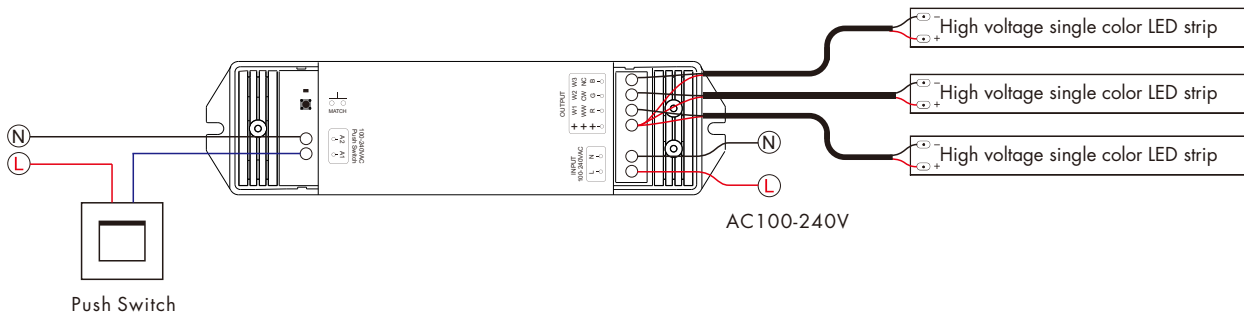

Press and hold match/set key for 8s, until the RUN LED indicator turn white, then release, the controller will become DIM type, then do smart config by tuya APP, or short press match key to match with dimming RF remote.

Note:

1. Press and hold Match/Set key for 2s, switch 3 kinds light type in sequence.
2. For CCT light type, continuous power on and off will change 3 levels color temperature (WW, NW and CW) in sequence.
3. Switch off the power, then switch on power, repeat again. Immediately short press match key 3 times, the light on/off time will change between 3s and 0.5s.

AC Push Dim Function (Optional)

Short press: Turn on or off light.

Long press (1-6s): Press and hold to step-less dimming, With every other long press, the light level goes to the opposite direction.

Dimming memory: Light returns to the previous dimming level when switched off and on again, even at power failure.

Tuya APP network connection

Push twice Match/Set key fastly, or when press and hold Match/Set key for 8-12s to set 3 kinds light type:

Clear previous network connection, enter Smart config mode, the purple LED indicator flash fastly, the output LED will flash 10 times.

Press and hold Match/Set key for 2s:

Switch 3 kinds light type in sequence, notice this operation does not automatically clear previous network connection.

Press and hold Match key for 5s:

Clear previous network connection, enter AP config mode, the purple LED indicator flash slowly. If smart config failed, please try AP config.

Repeat power on and off for 5 consecutive times, also clear previous network connection, enter Smart config mode, the output LED will flash 10 times.

If Tuya APP network connection succeed, the purple LED indicator will stop flash, and in Tuya APP, you can find RGB device (or other DIM, CCT).

Tuya APP interface

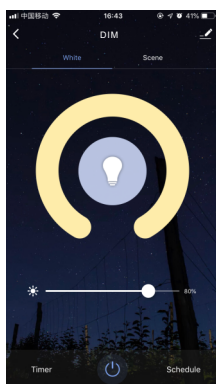

White interface

For DIM type:
Touch brightness slide
to adjust brightness.

For RGB type:
Touch brightness slide,
get RGB mixed white firstly,
then to adjust white brightness.

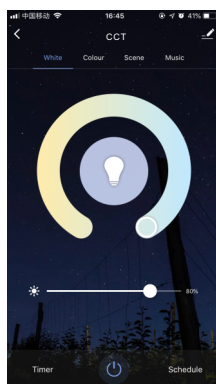

Color temperature interface

For CCT type:
Touch color wheel
to adjust color temperature.
Touch brightness slide
to adjust brightness.

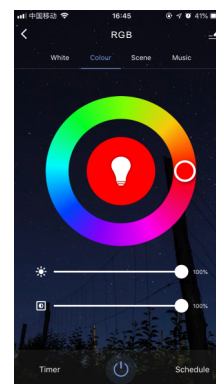

Colour interface

For RGB type:
Touch color wheel
to adjust static RGB color.
Touch brightness slide
to adjust color brightness.
Touch saturation slide
to adjust color saturation,
namely gradient from the current
color to white(RGB mixed).

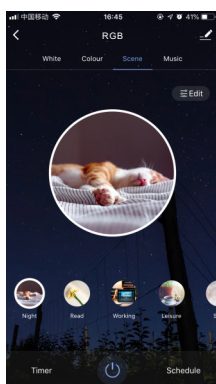

Scene interface

The 1-4 scene is static color for all light type.
the inner color of these scene can be editable.
The 5-8 scene is dynamic mode for RGB type,
such as green fade in and fade out, RGB jump,
6 color jump, 6 color smooth.

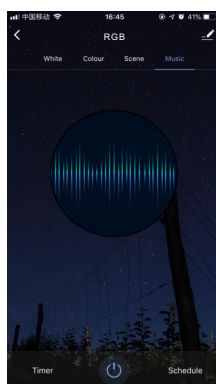

Music, Timer, Schedule

The music play can use smart phone music player
or micro-phone as music signal input.
The Timer key can turn on or turn off light in the next 24 hours.
The Schedule key can add multiple timers to turn on
or turn off light according to different time periods.

S3(WT) match remote control (Optional)

End user can choose the suitable match/delete ways. Two options are offered for selection:

Use the S3(WT)'s Match key

Match:

Short press match key of S3(WT), immediately press on/off key (single zone remote) or zone key (multiple zone remote) on the remote. The LED indicator fast flash a few times means match is successful.

Delete:

Press and hold match key of S3(WT) for 1.5s, The LED indicator fast flash a few times means all matched remotes were deleted.

Use Power Restart

Match:

Switch off the power of S3(WT), then switch on power, repeat again. Immediately short press on/off key (single zone remote) or zone key (multiple zone remote) 3 times on the remote. The light blinks 3 times means match is successful.

Delete:

Switch off the power of S3(WT), then switch on power, repeat again. Immediately short press on/off key (single zone remote) or zone key (multiple zone remote) 5 times on the remote. The light blinks 5 times means all matched remotes were deleted.

S3(WT) work as WiFi-RF converter to match RF LED controller or dimming driver

End user can choose the suitable match/delete ways. Two options are offered for selection:

Use the controller's Match key

Match:

Short press match key of the controller, immediately press on/off key on the Tuya APP. The LED indicator fast flash a few times means match is successful.

Delete:

Press and hold match key of the controller for 5s, The LED indicator fast flash a few times means match was deleted.

Use Power Restart

Match:

Switch off the power of the controller, then switch on power, repeat again. Immediately short press on/off key 3 times on the Tuya APP. The light blinks 3 times means match is successful.

Delete:

Switch off the power of the controller, then switch on power, repeat again. Immediately short press on/off key 5 times on the Tuya APP. The light blinks 5 times means match was deleted.

RGB dynamic mode list

No.	Name	No.	Name
1	RGB jump	6	RGB fade in and out
2	RGB smooth	7	Red fade in and out
3	6 color jump	8	Green fade in and out
4	6 color smooth	9	Blue fade in and out
5	Yellow cyan purple smooth	10	White fade in and out