

**20.54.1702.00**

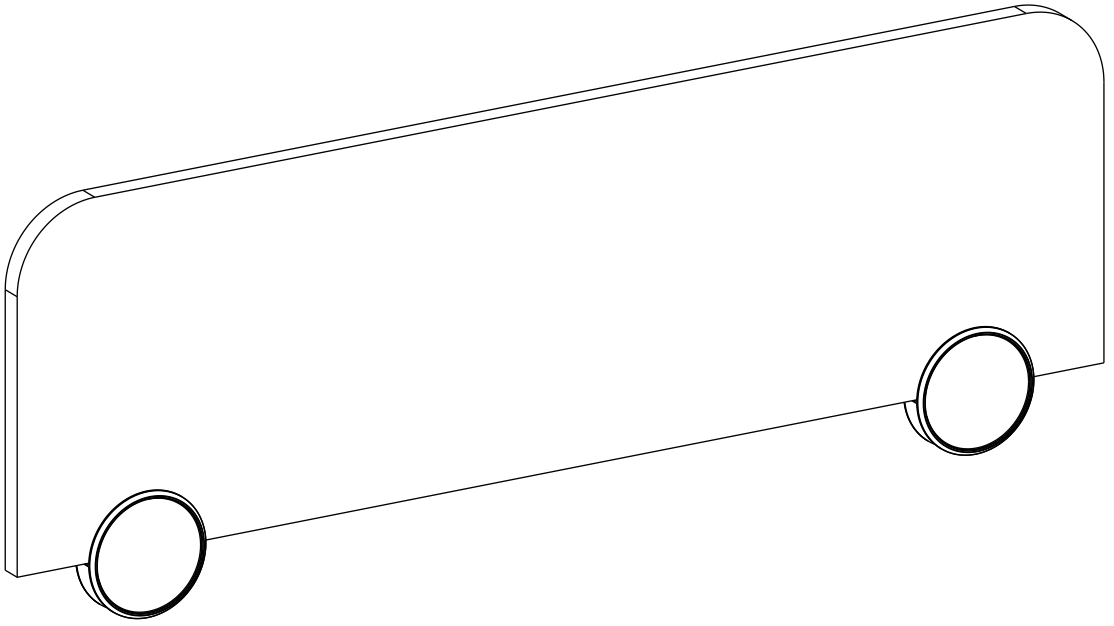

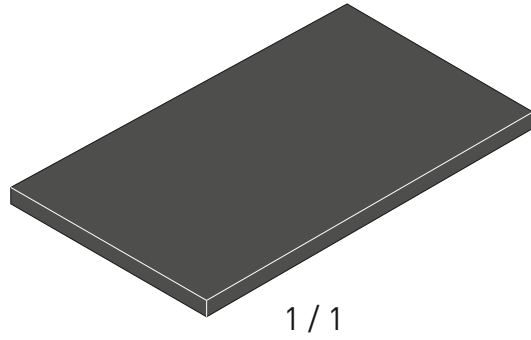
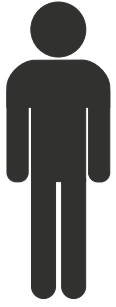

1 / 1

1 / 1

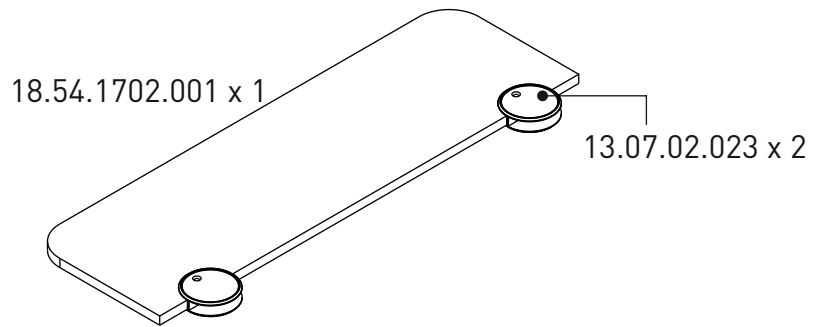

1

