

20.52.1302.01

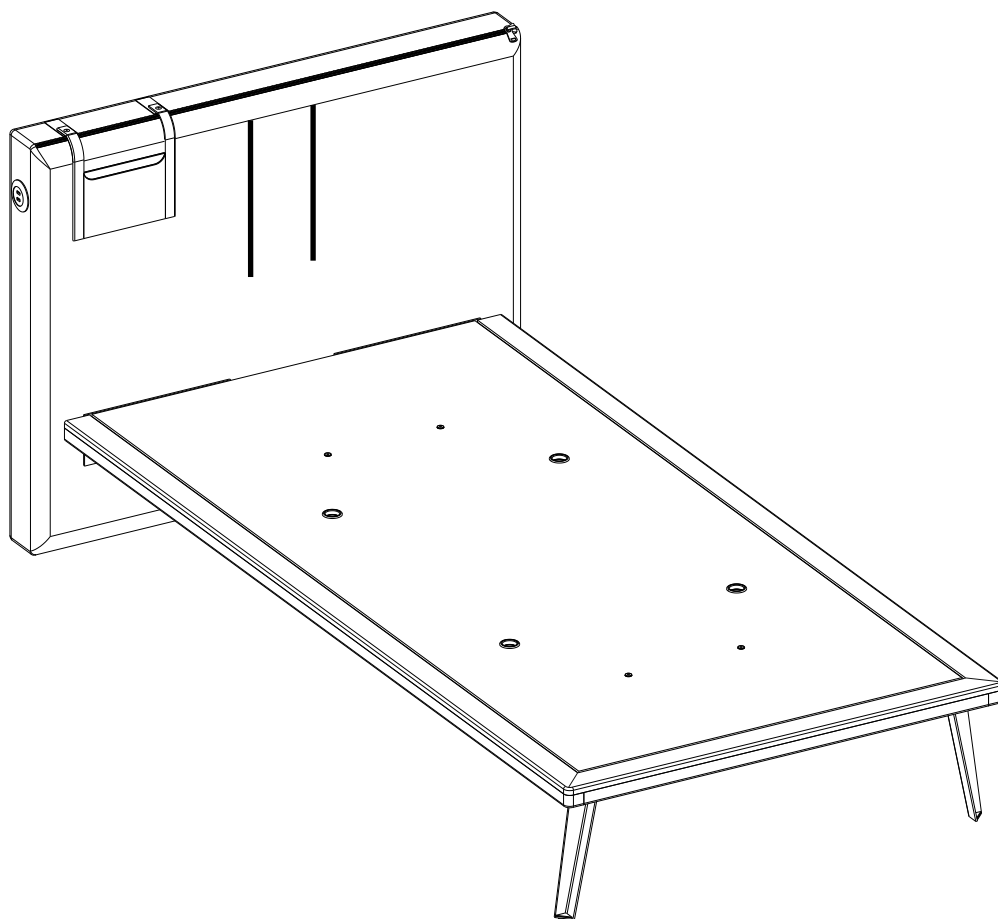

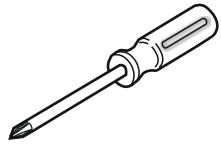

21.20.1013.00

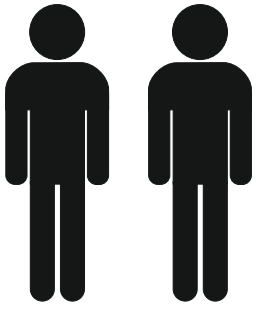
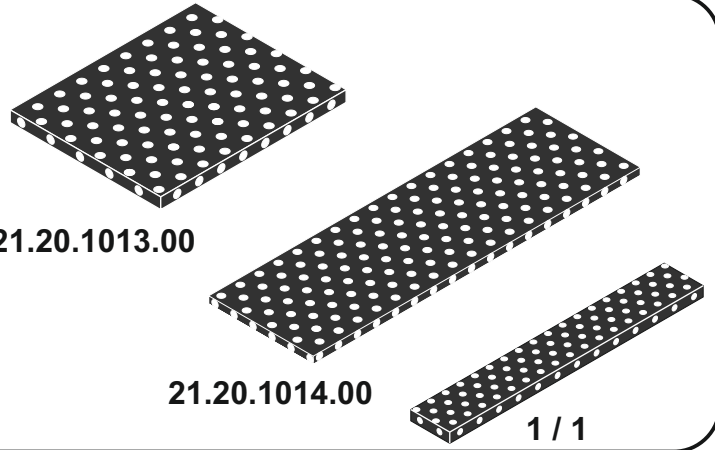

21.20.1014.00

1 / 1



13.07.01.063 x 8

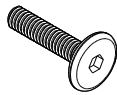

13.03.01.027 x 4
M6x25

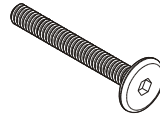

13.03.01.029 x 2
M6x30

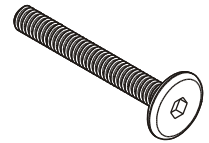

13.03.01.037 x 4
M6x45

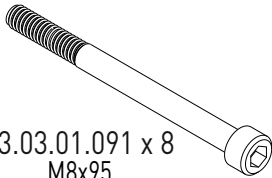

13.03.01.091 x 8
M8x95

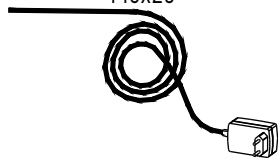

13.15.01.164 x 1

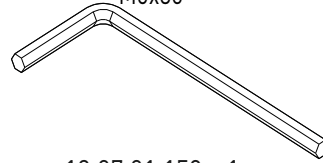

13.07.01.158 x 1

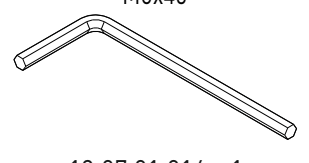

13.07.01.016 x 1

3 / 1

13.10.01.211 x 1

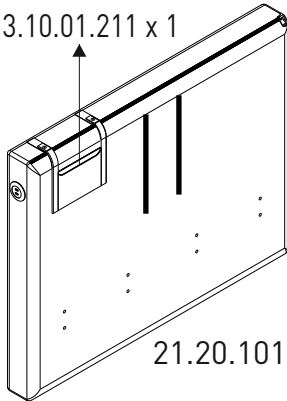

21.20.1013.00 x 1

3 / 2

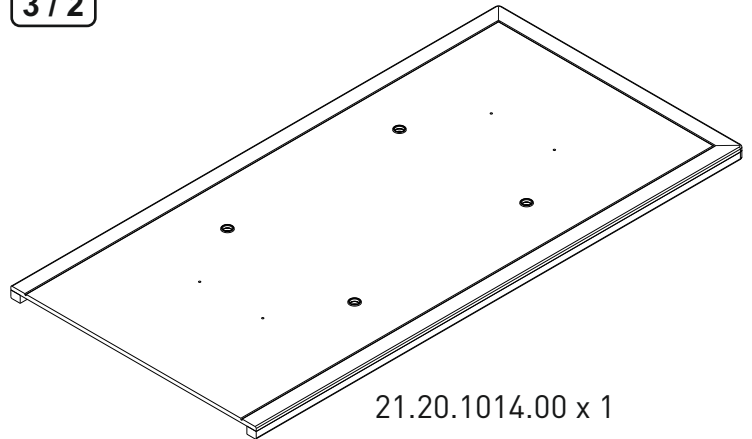

21.20.1014.00 x 1

3 / 3

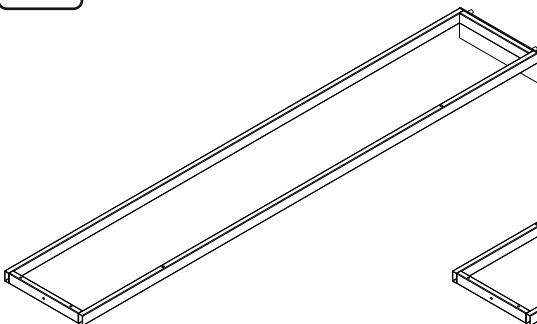

18.52.1302.205 x 1

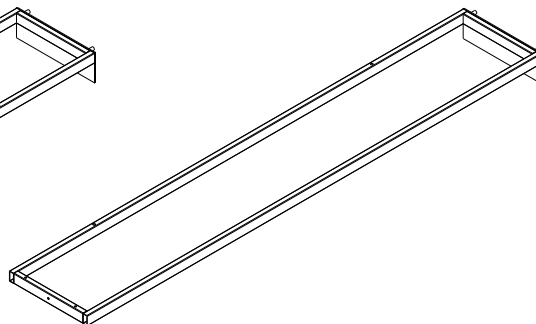

18.52.1302.206 x 1

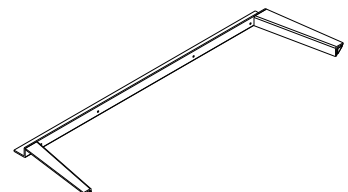

18.52.1302.207 x 1

1

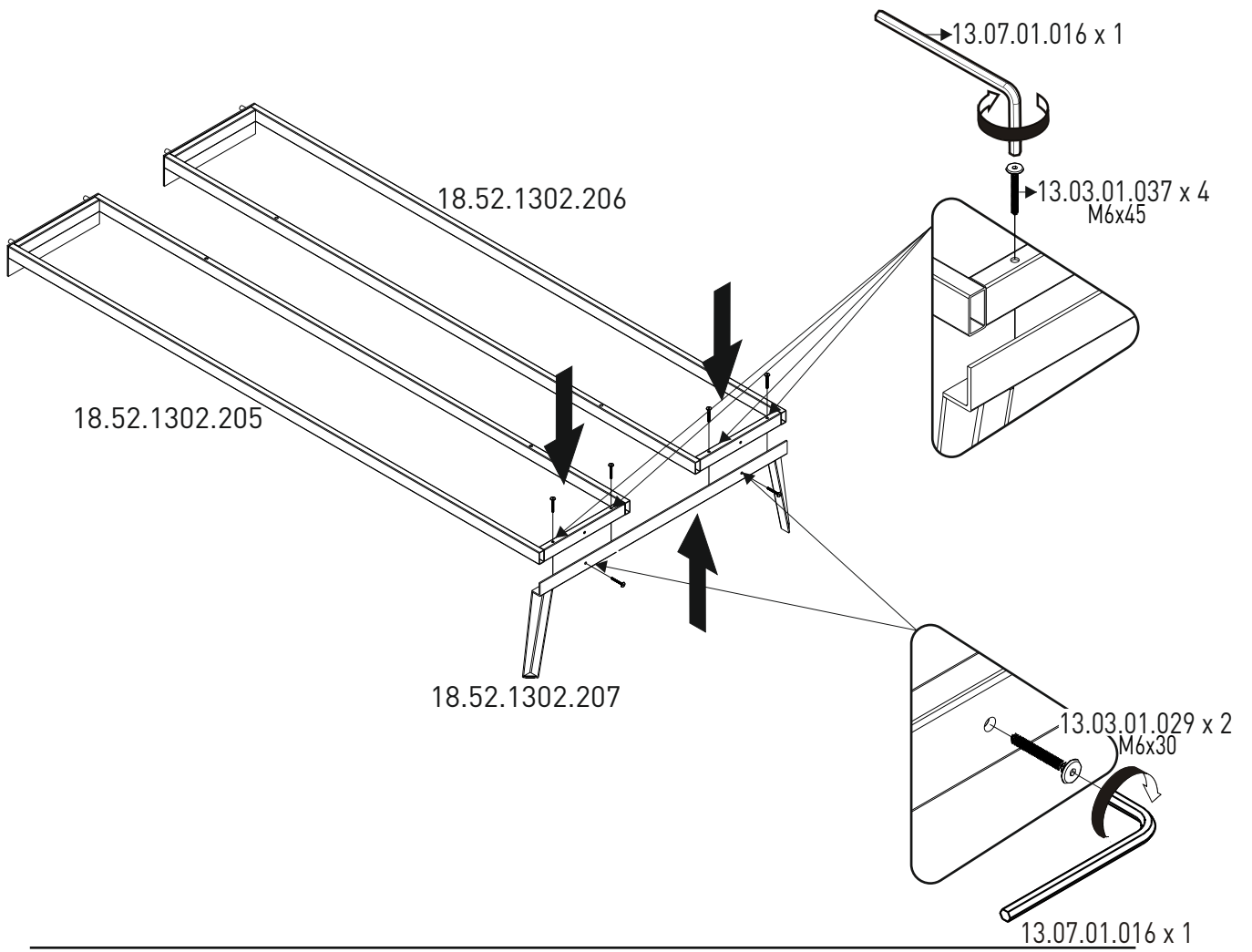

2

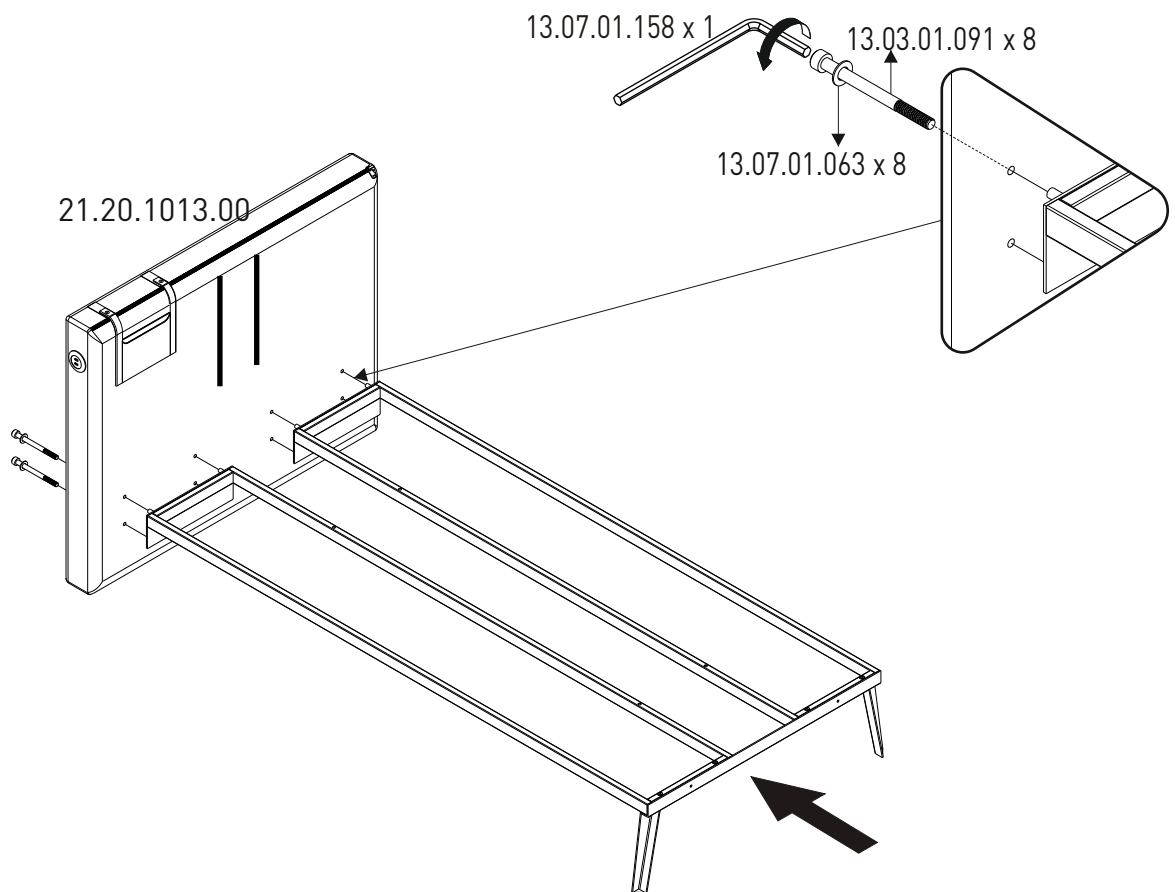

3

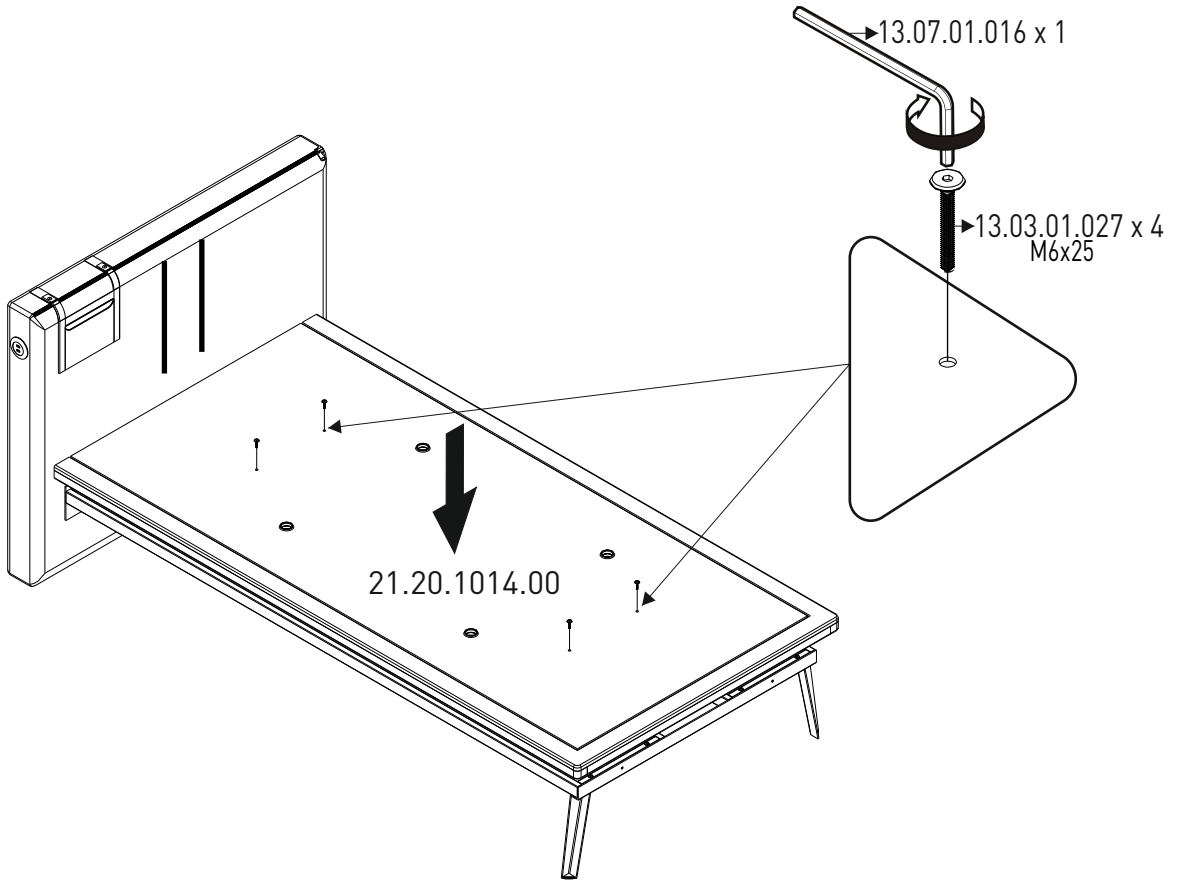

4

