

20.76.1014.00

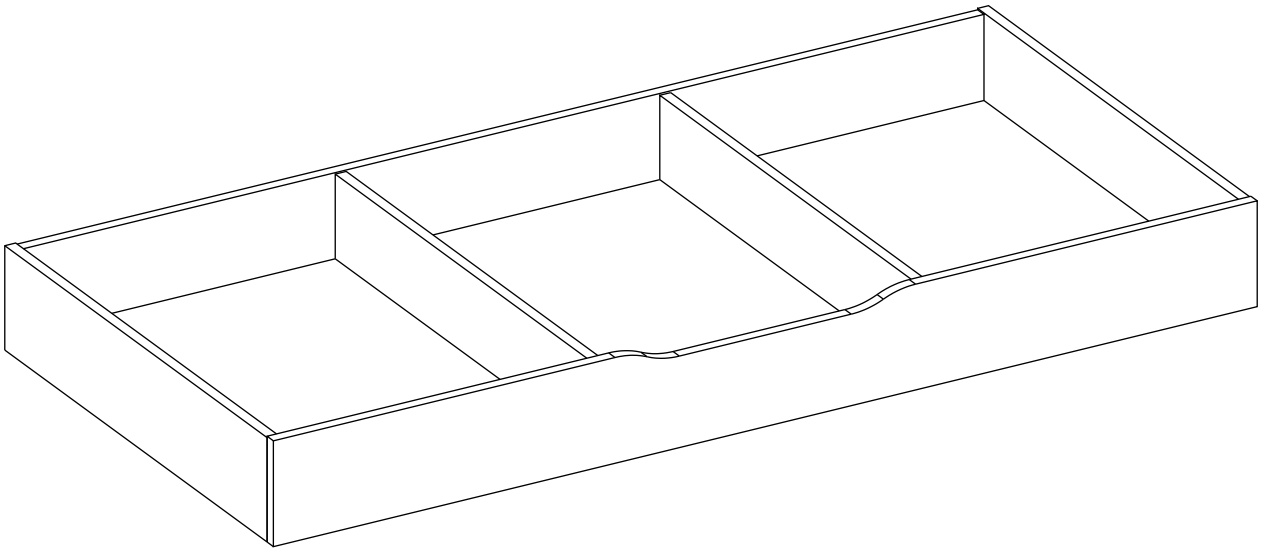

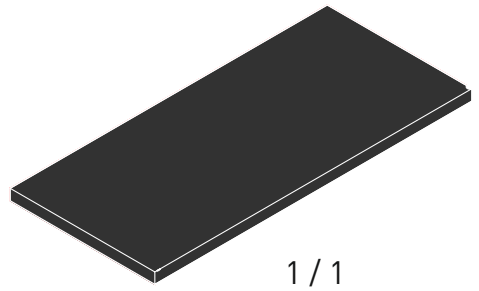

1 / 1

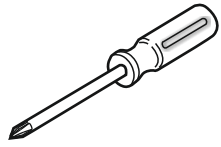
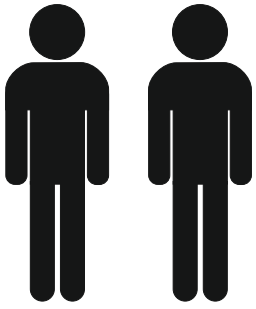
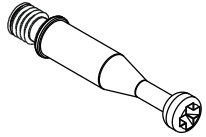

13.07.01.108 x 16



13.07.01.110 x 16

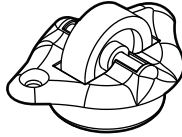

13.01.01.005 x 4

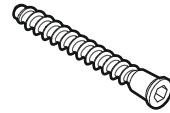

13.02.01.019 x 6



13.01.01.107 x 4



4x16

13.02.01.004 x 4

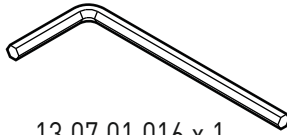

13.07.01.016 x 1

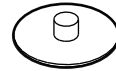

13.01.01.045 x 16

1 / 1

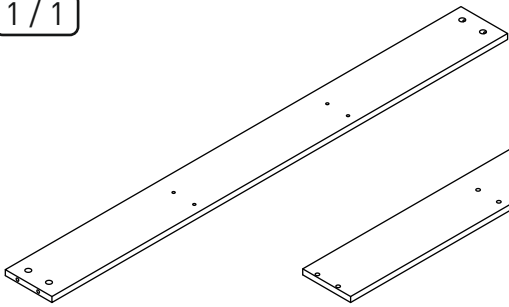

18.76.1014.004 x 1

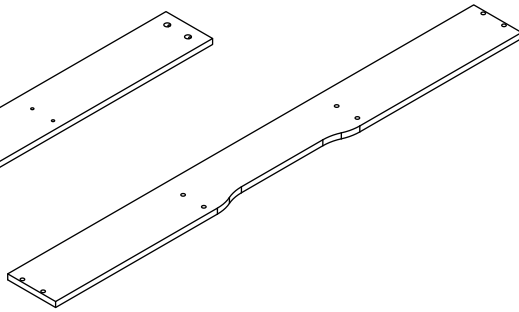

18.76.1014.003 x 1

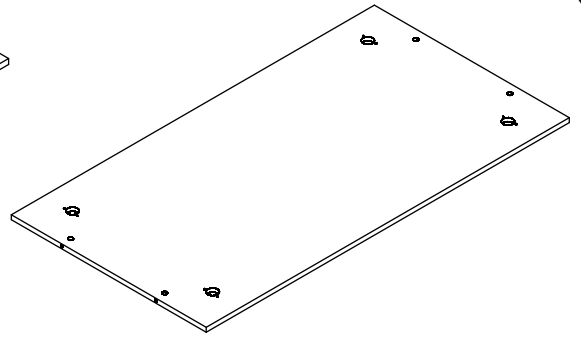

18.76.1014.006 x 1

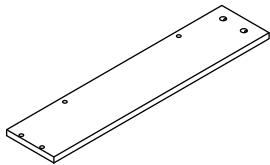

18.76.1014.001 x 1

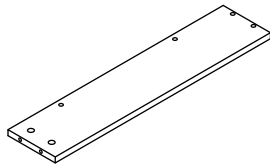

18.76.1014.002 x 1

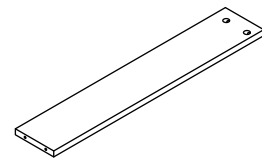

18.76.1014.005 x 2

1

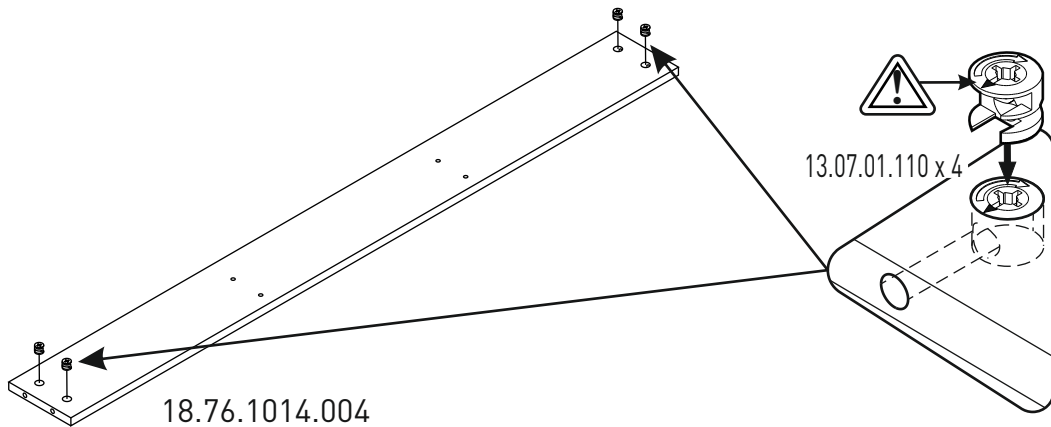

2

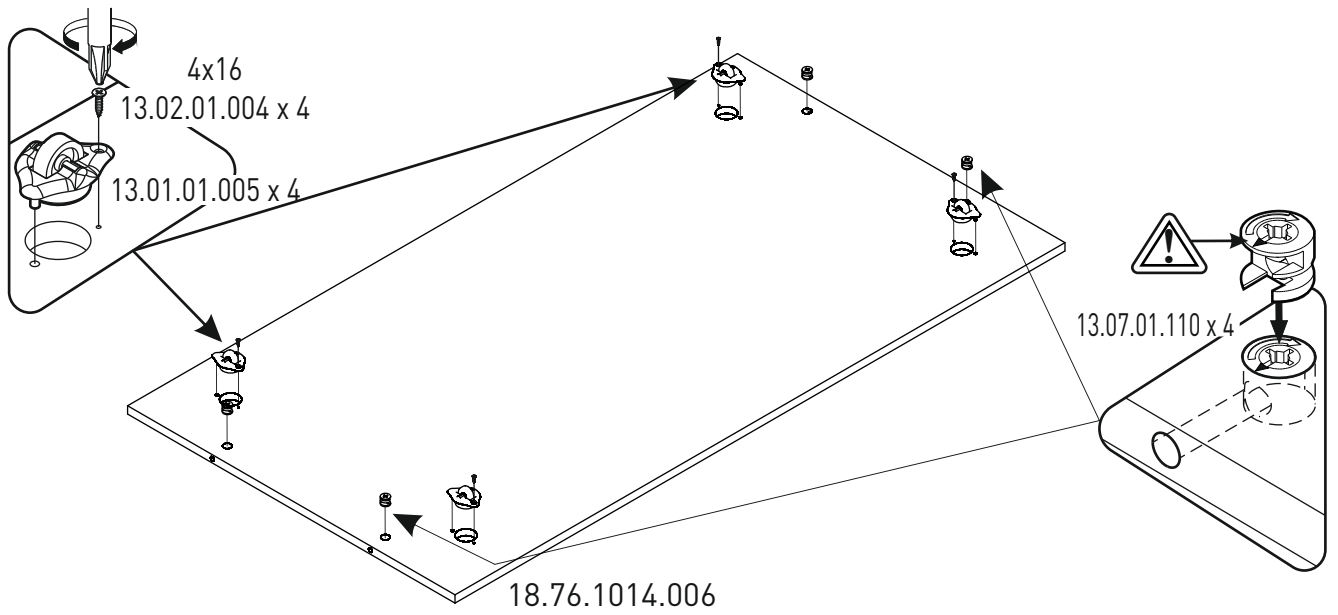

3

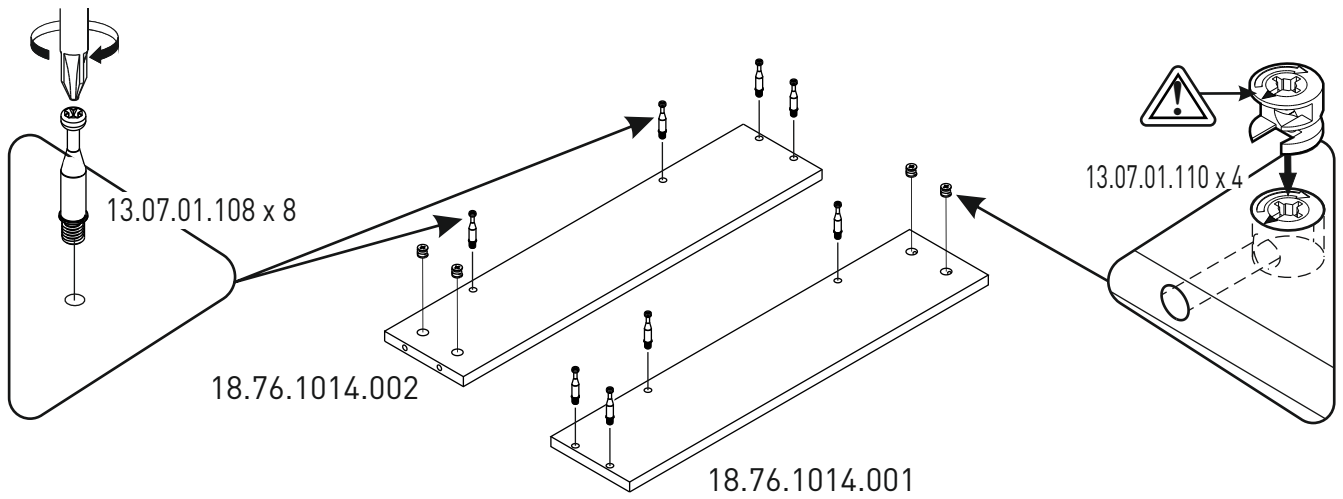

4

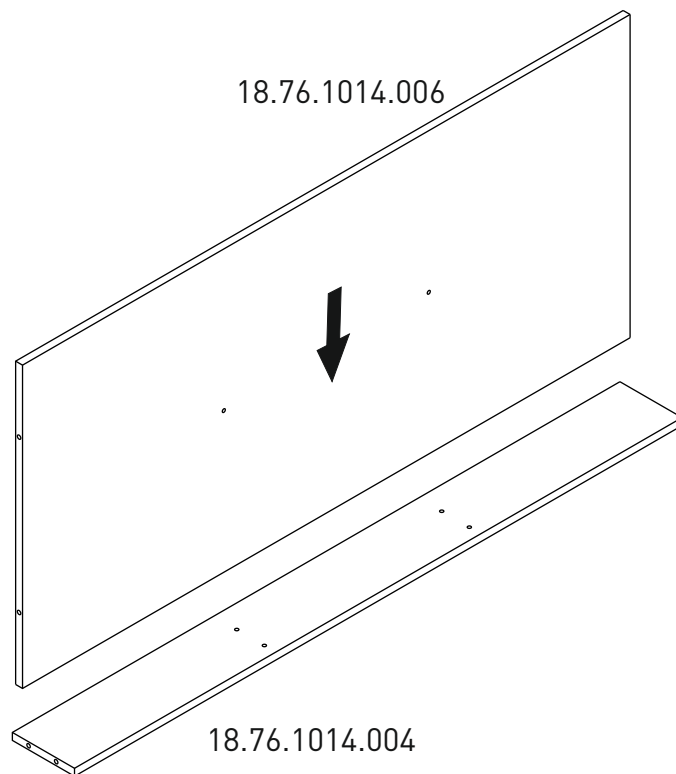

5

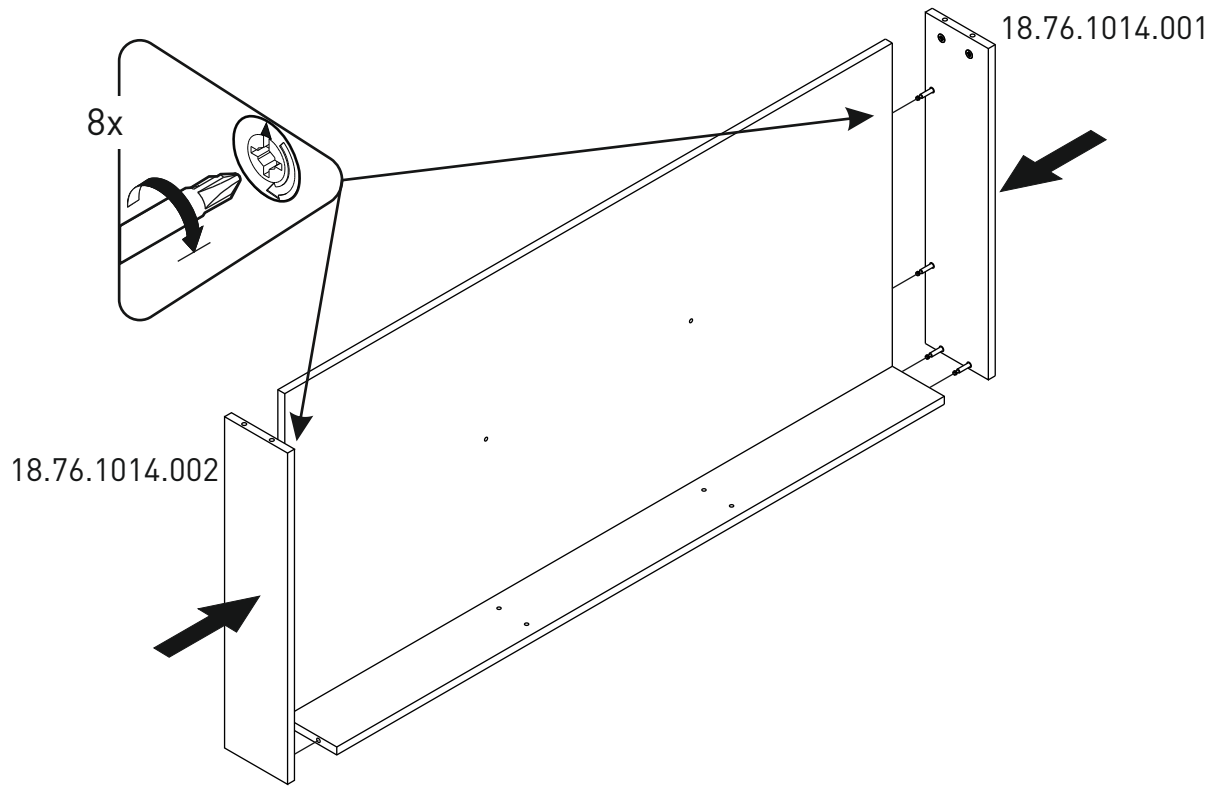

6

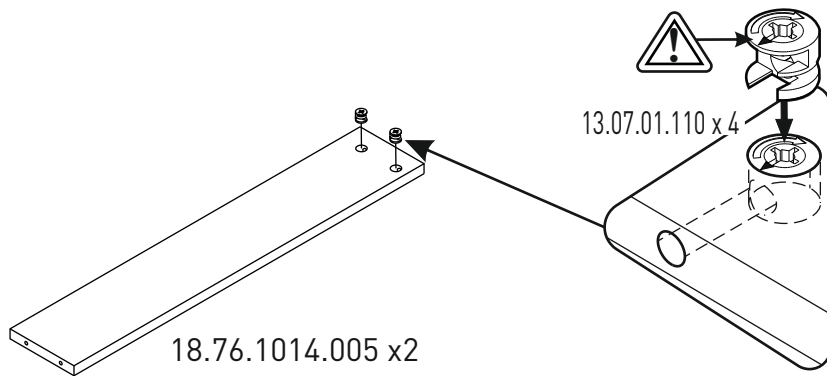

7

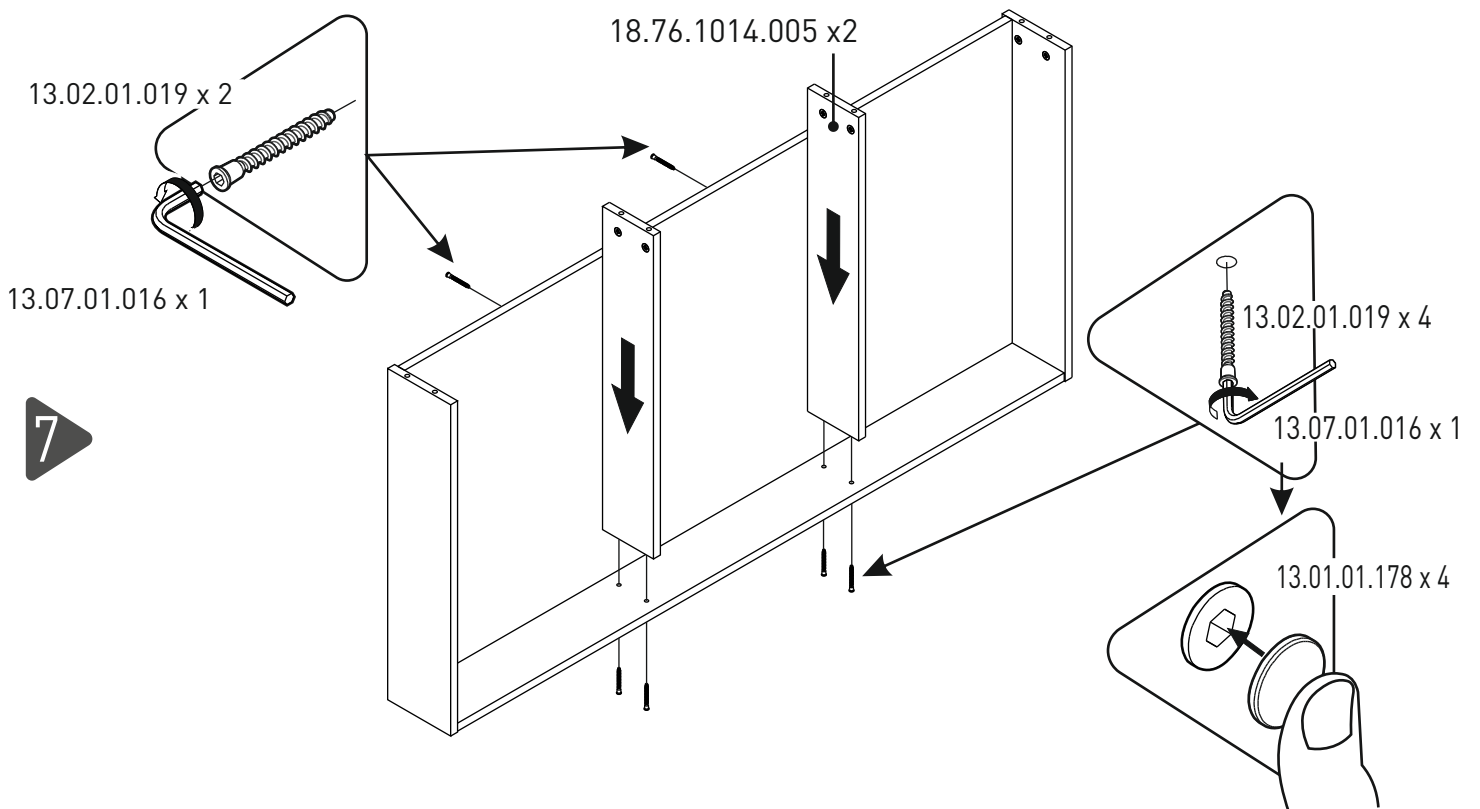

8

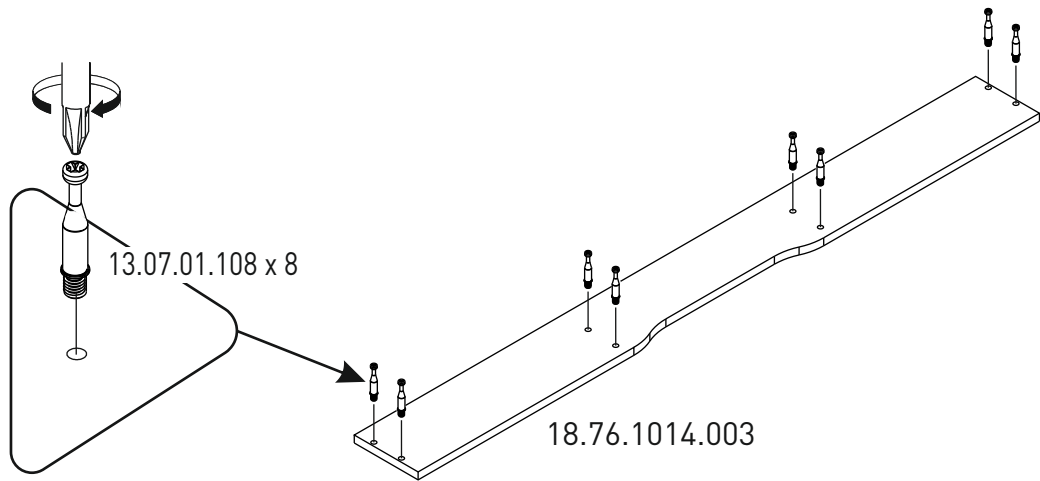

9

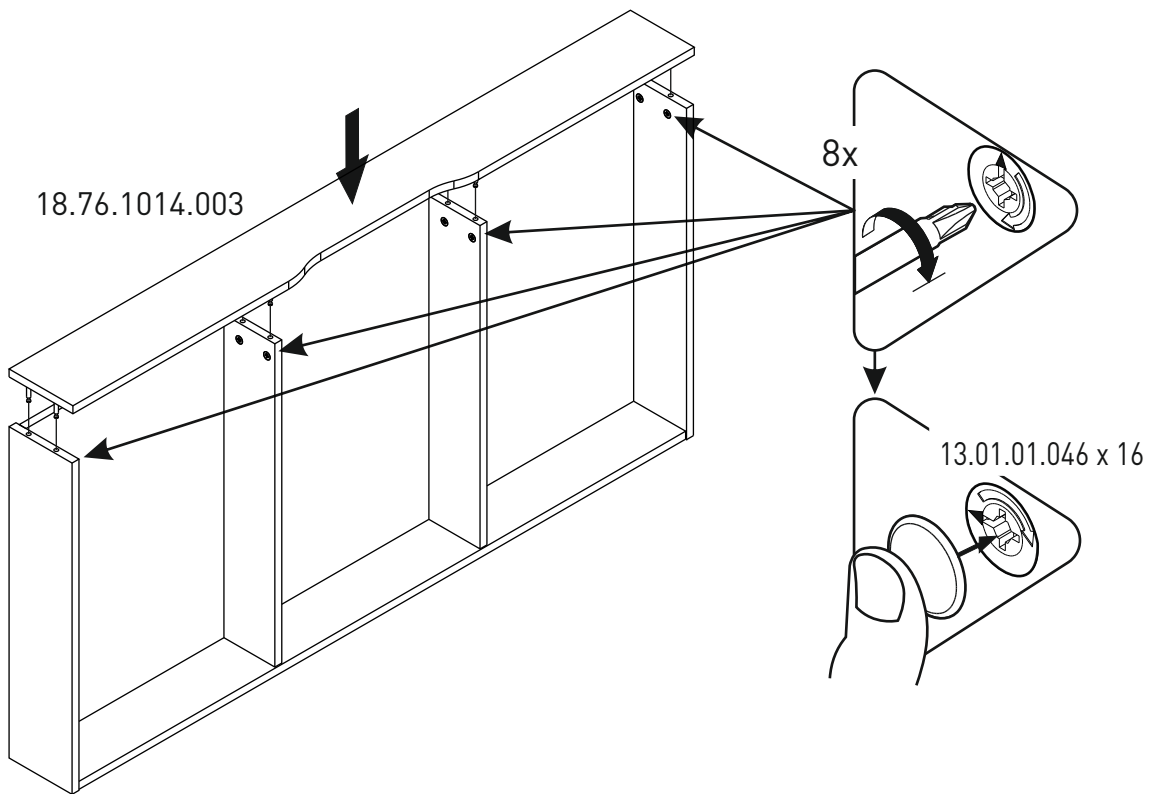

10

