

20.02.1351.00

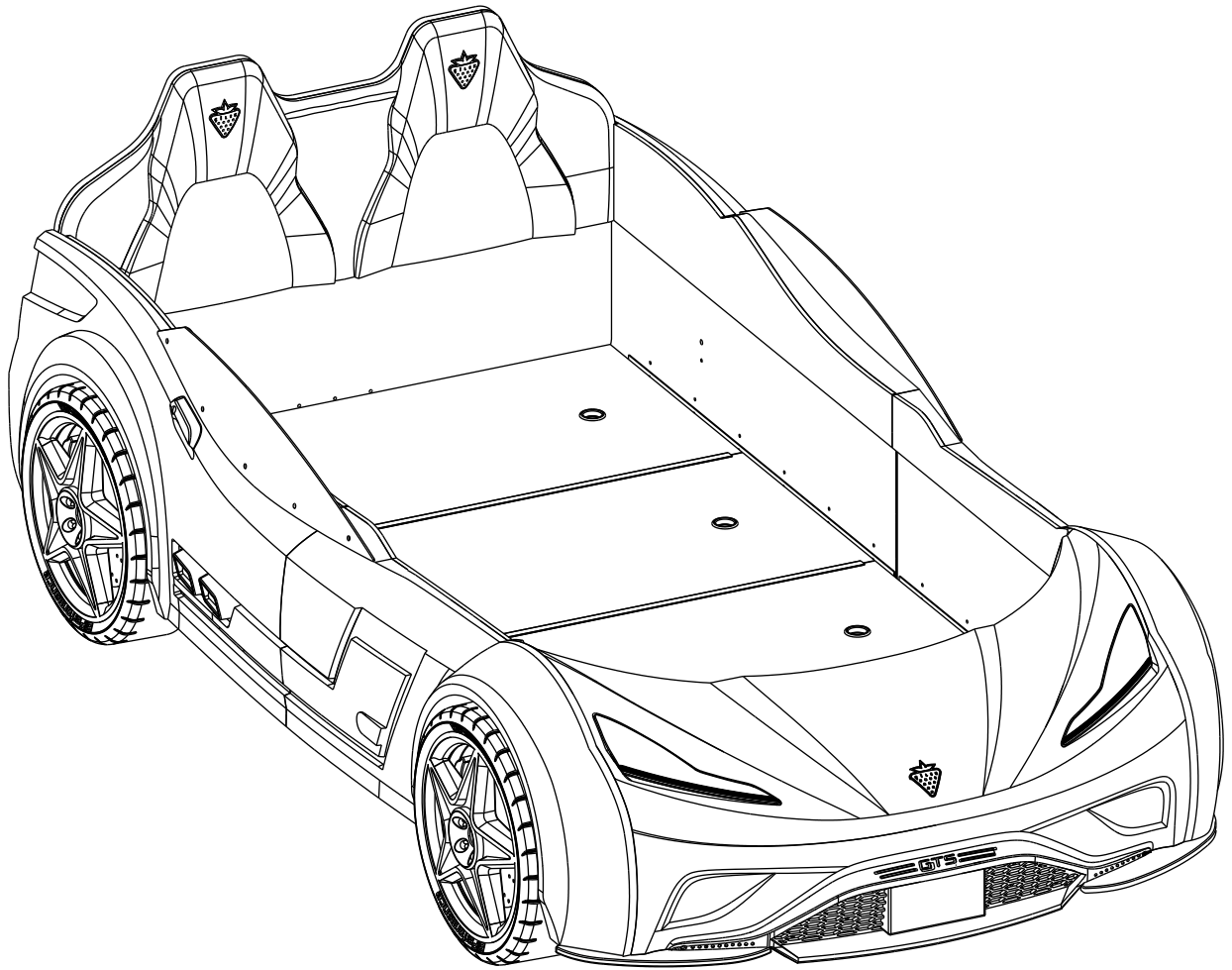

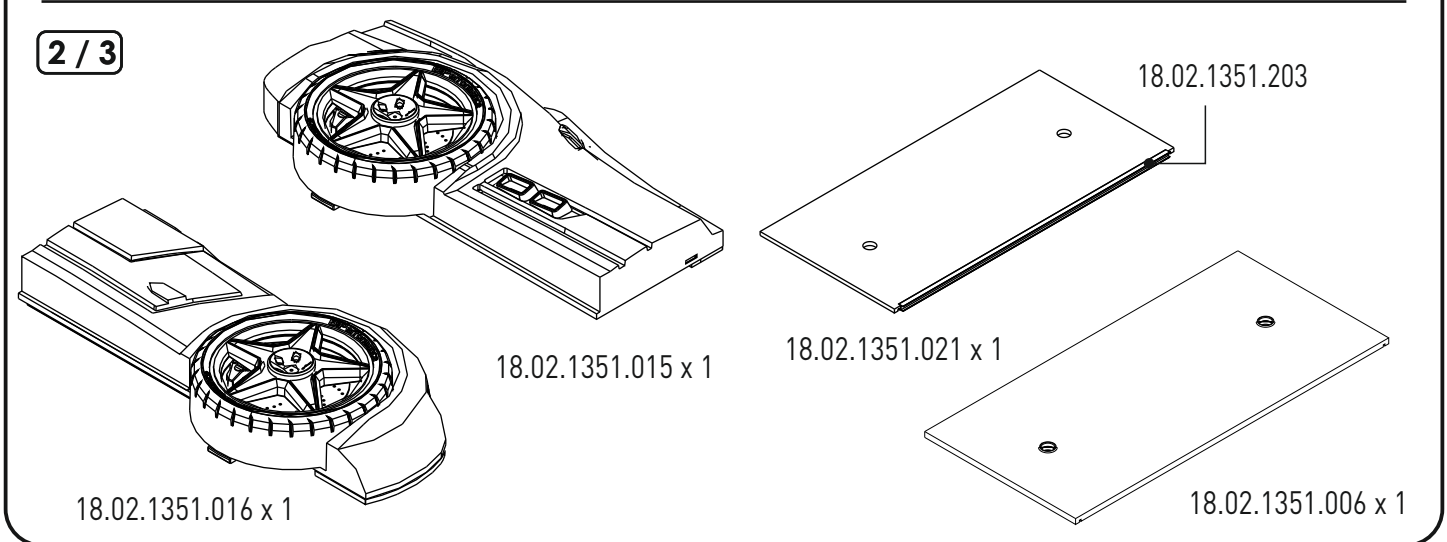

3 / 3

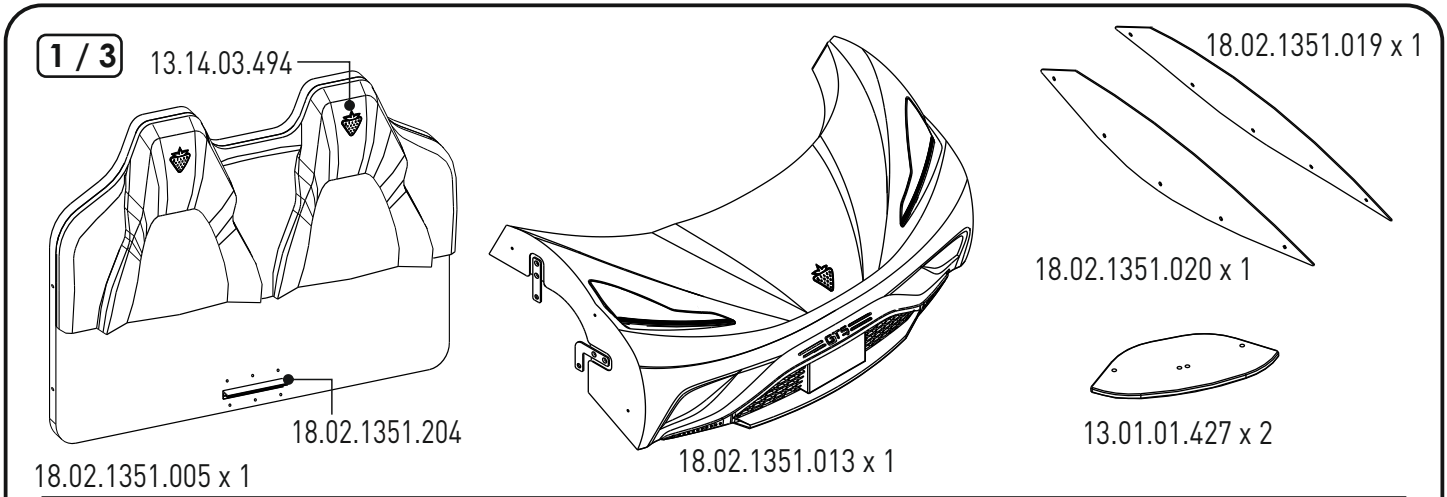
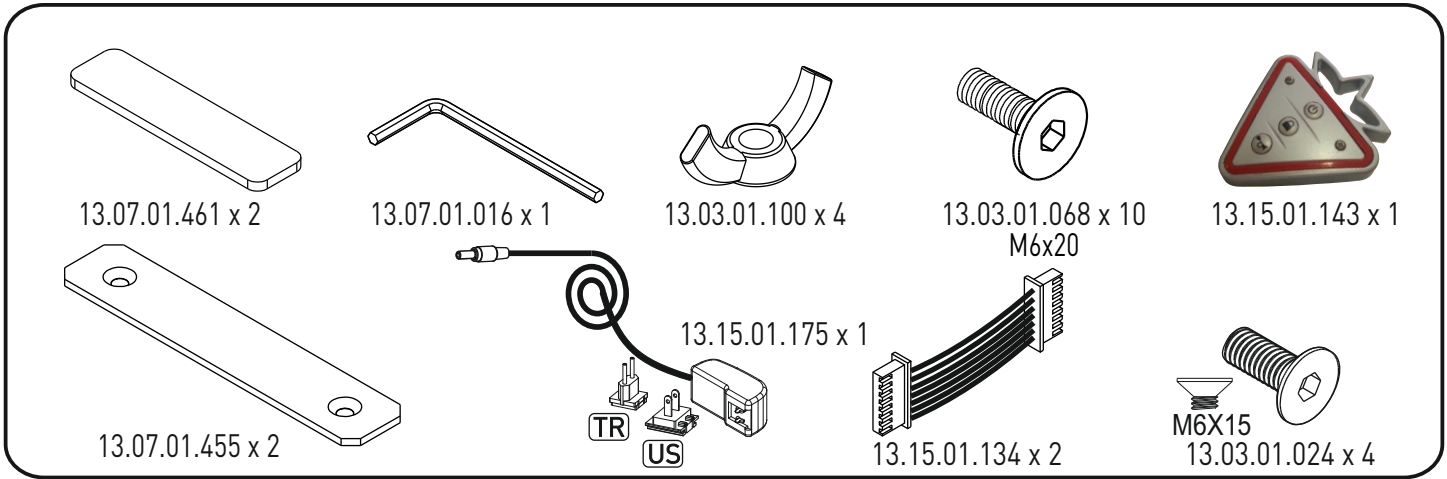
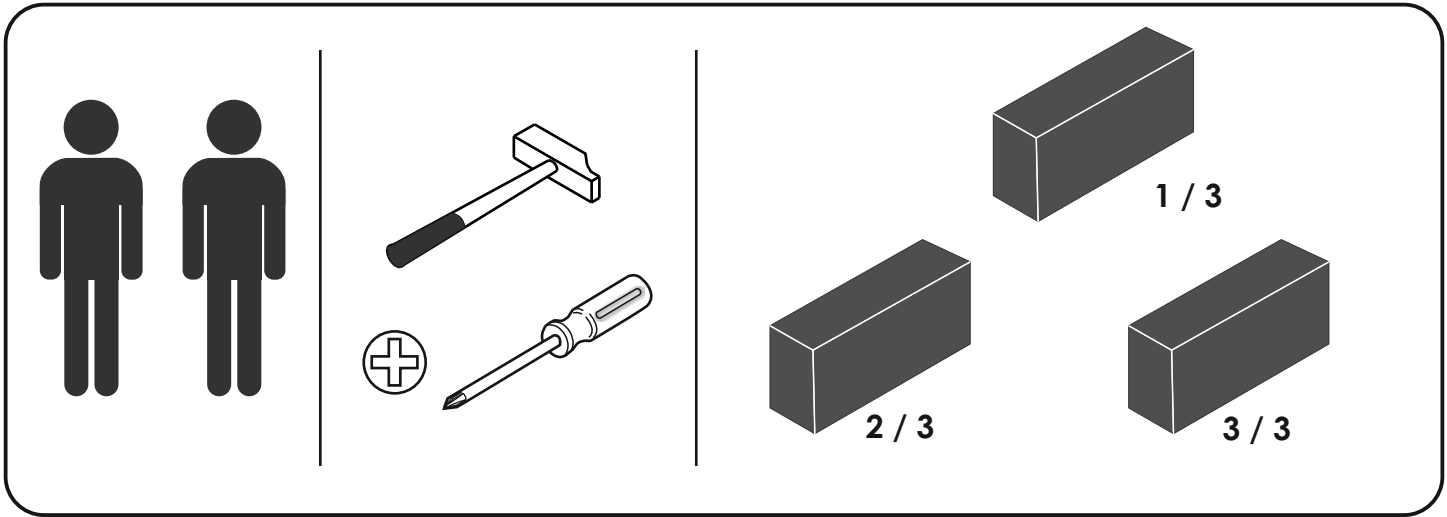
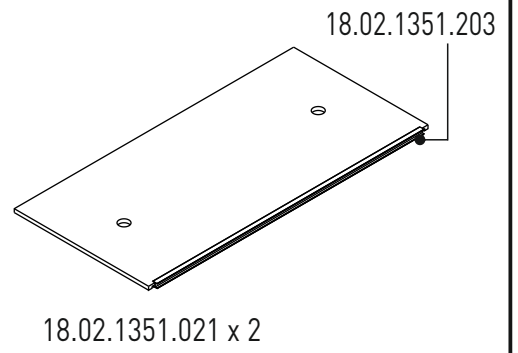
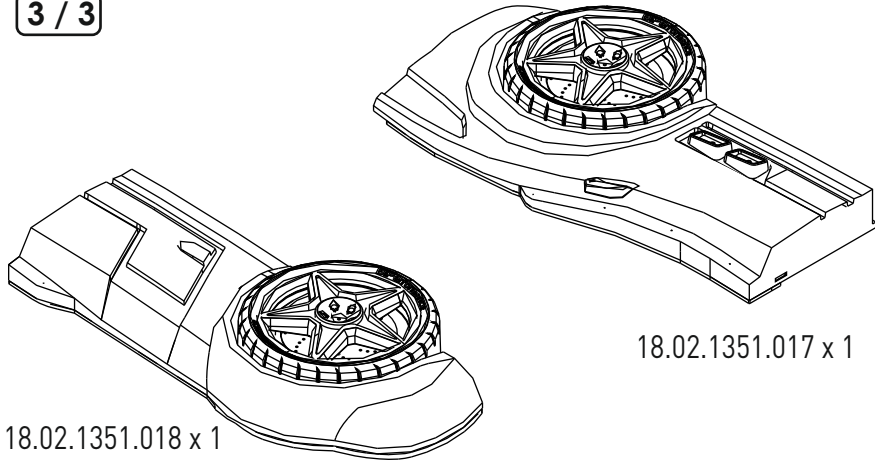

1

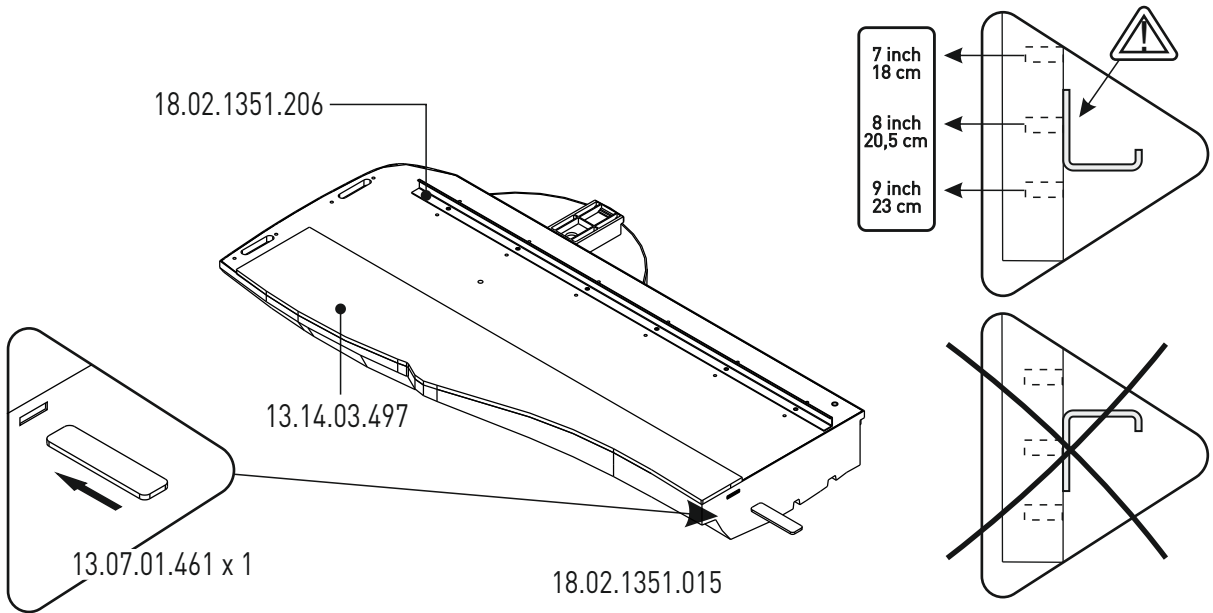

2

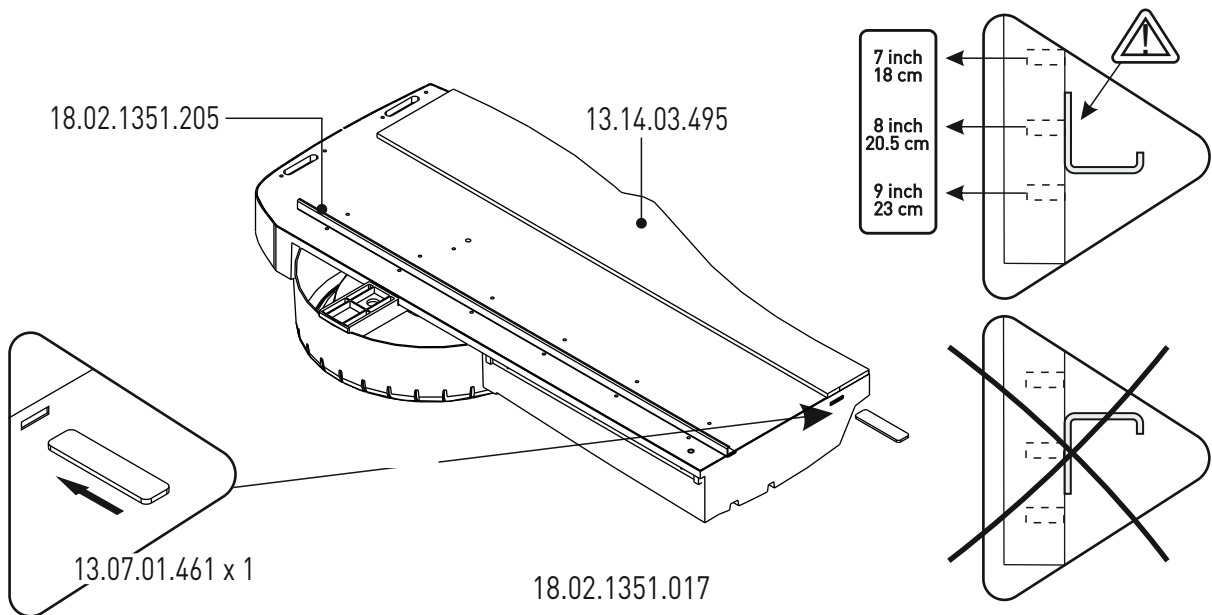

3

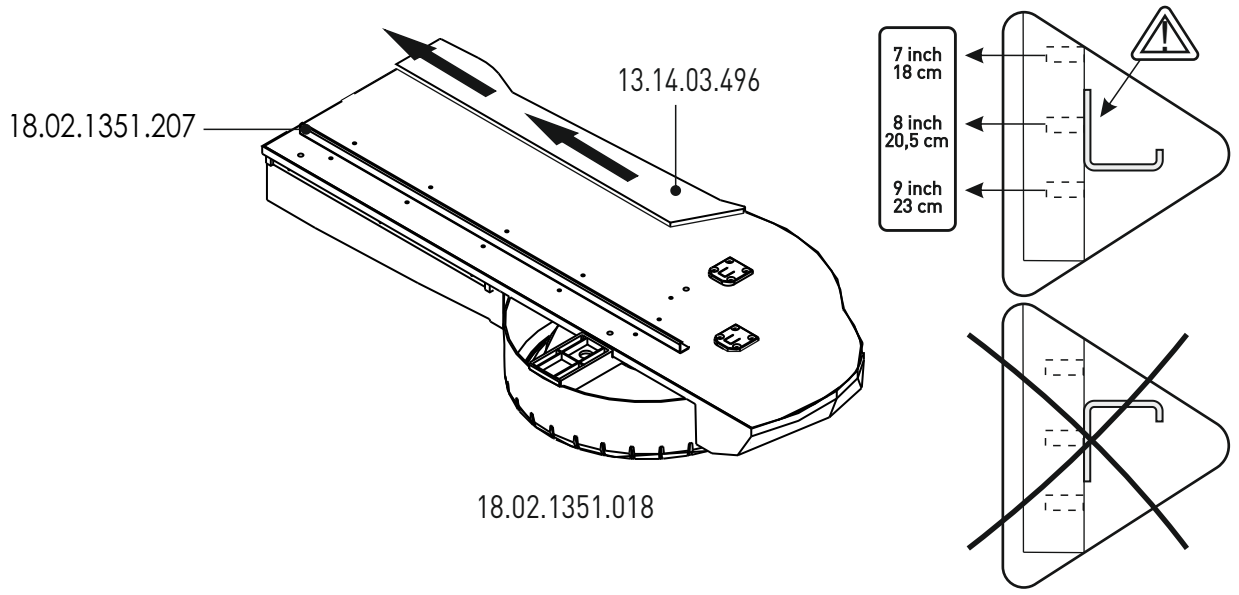

4

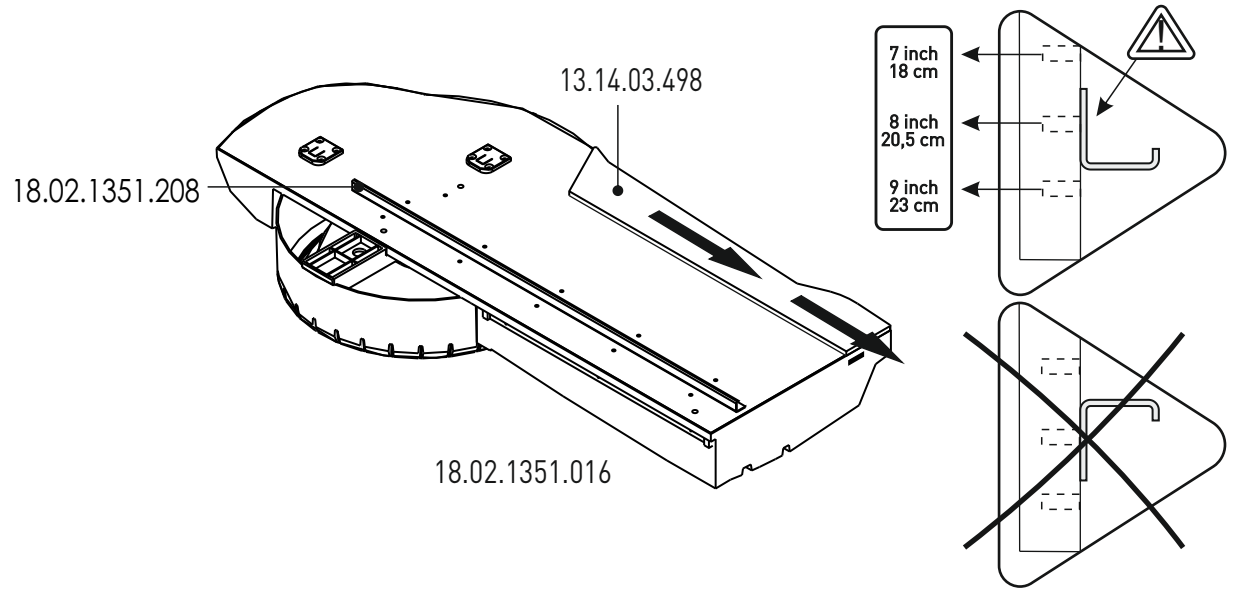

5

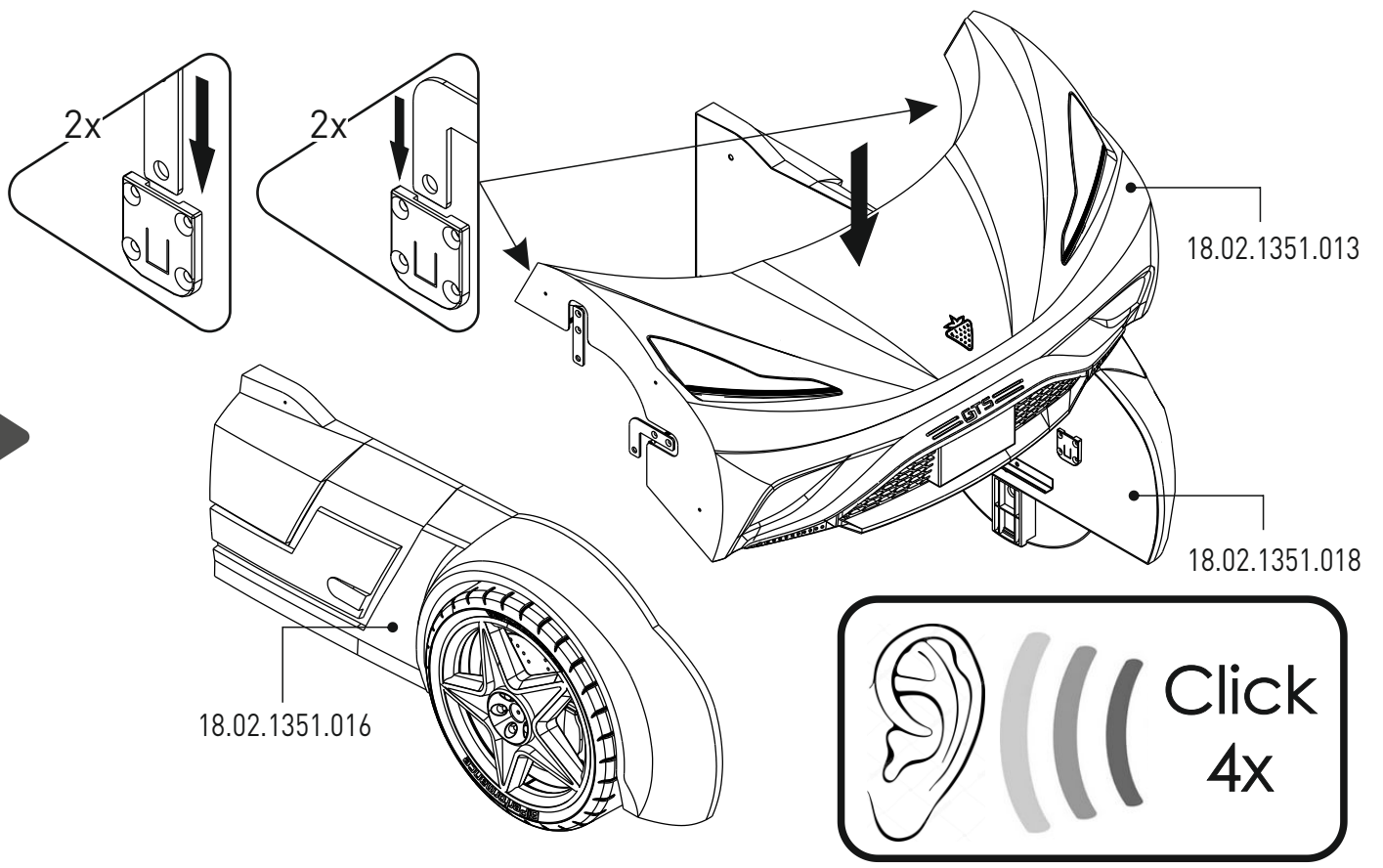

6

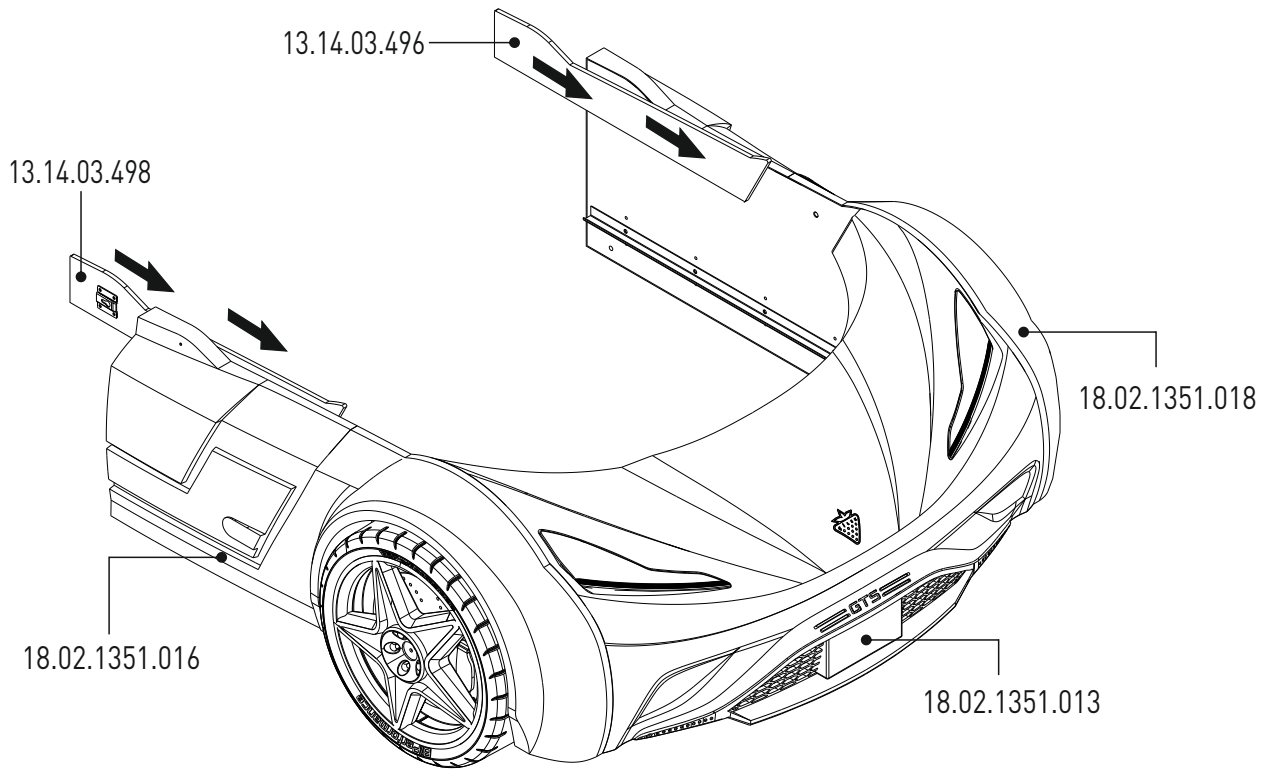

7

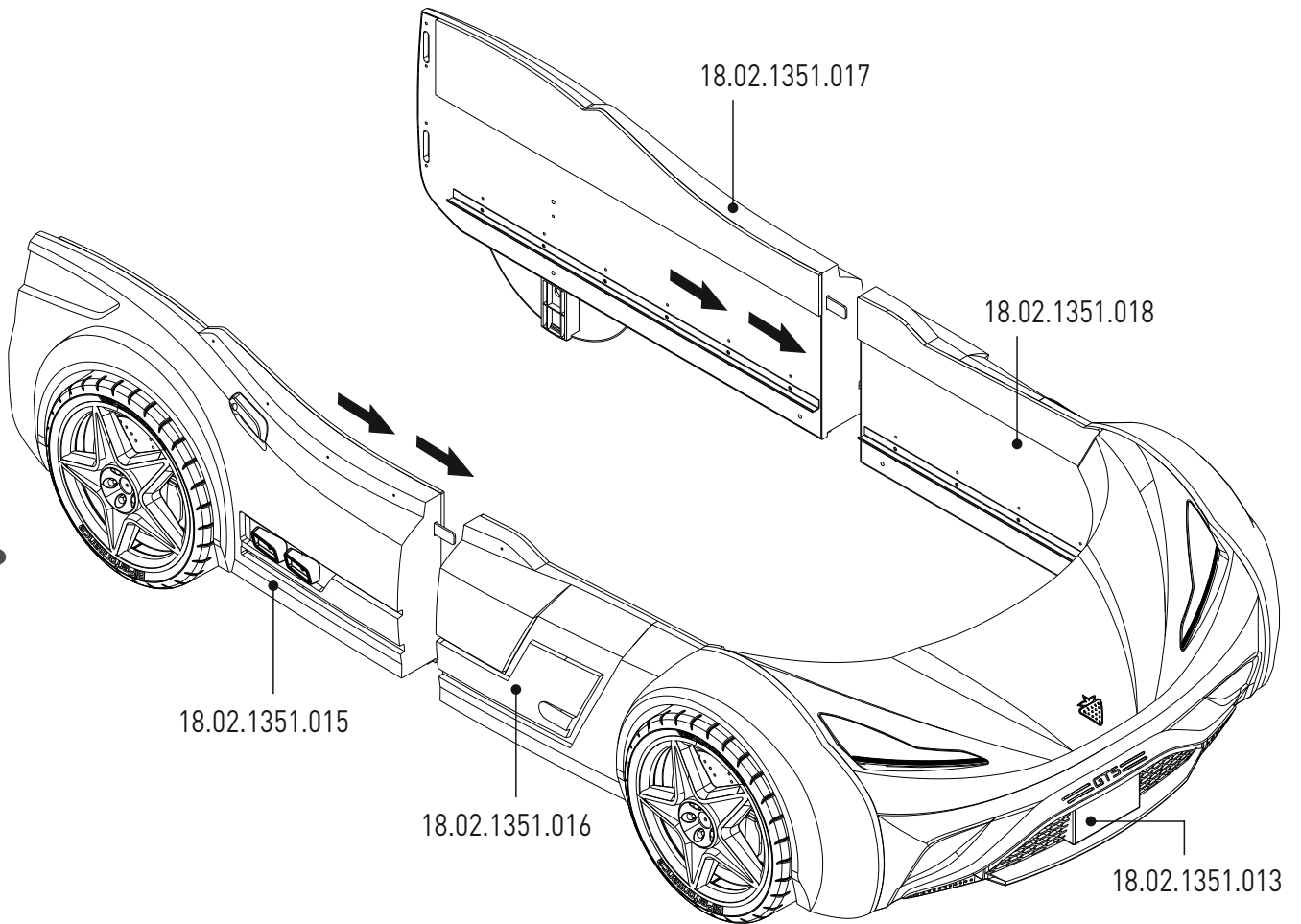

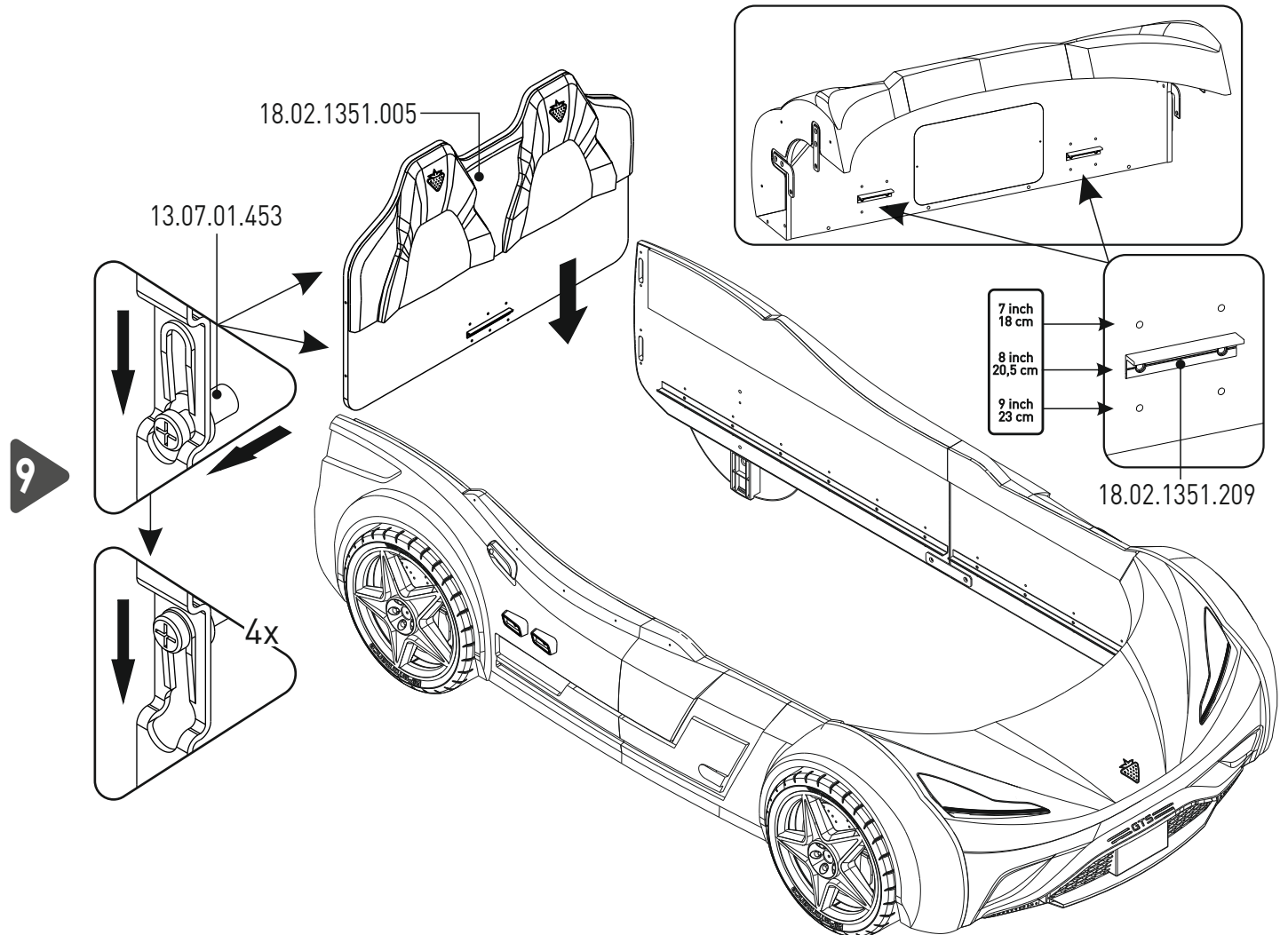
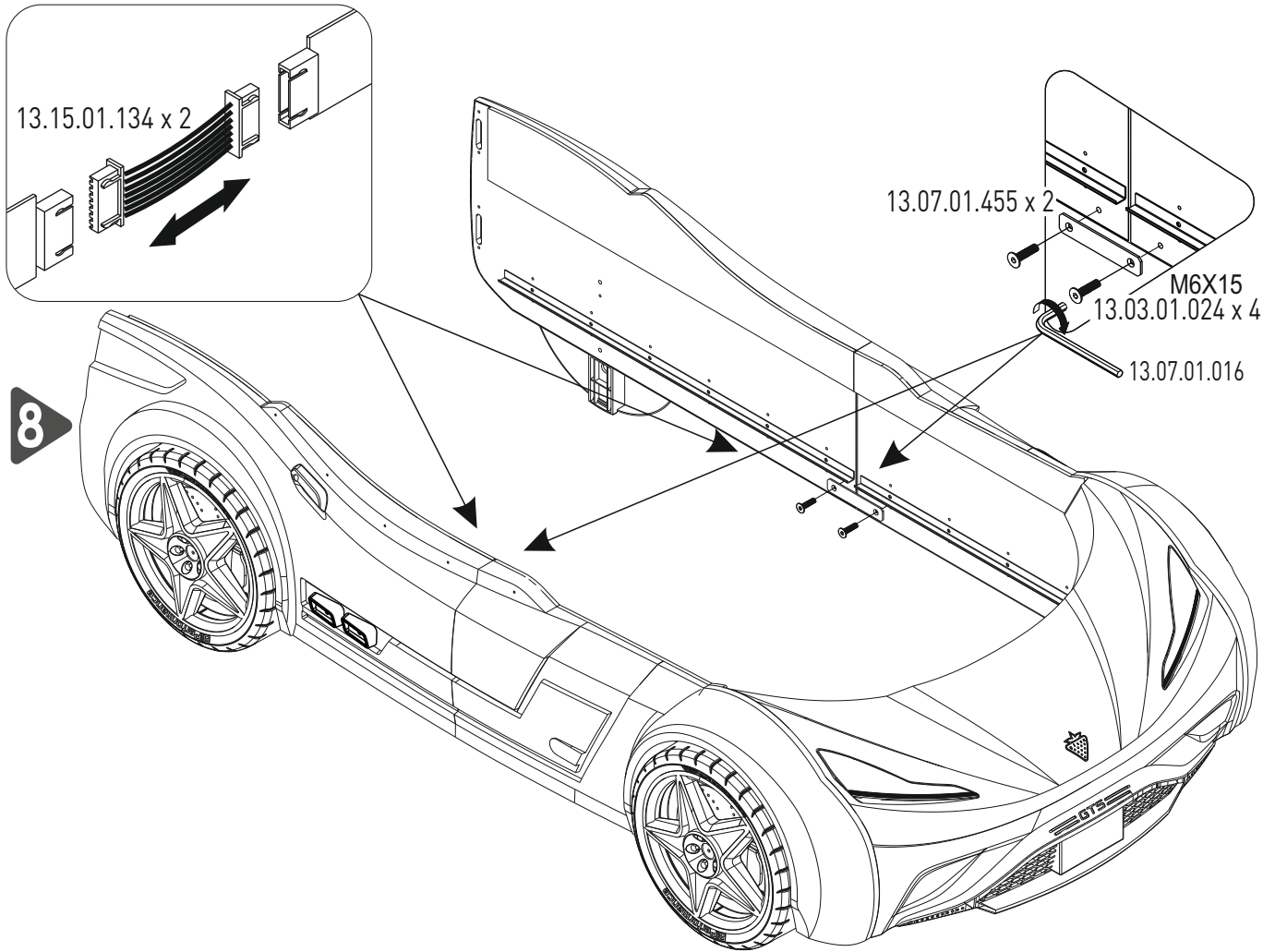

10

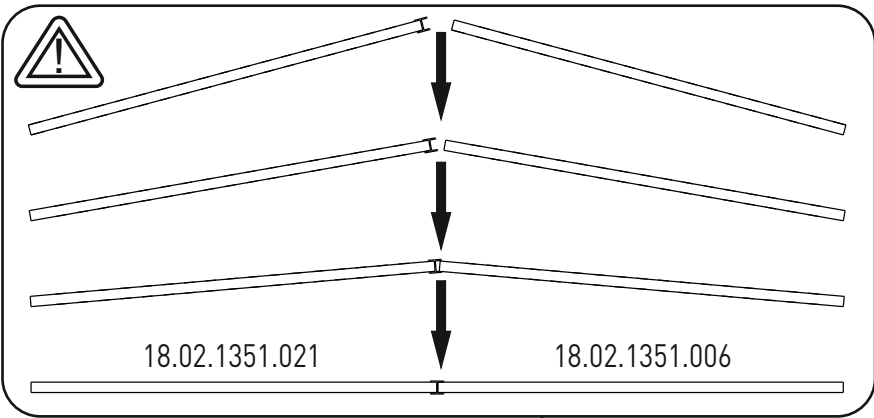
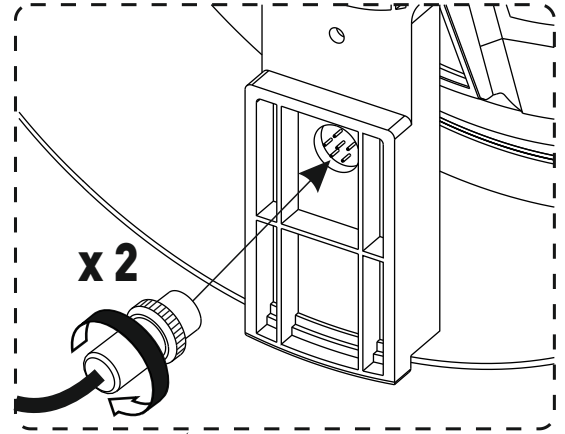
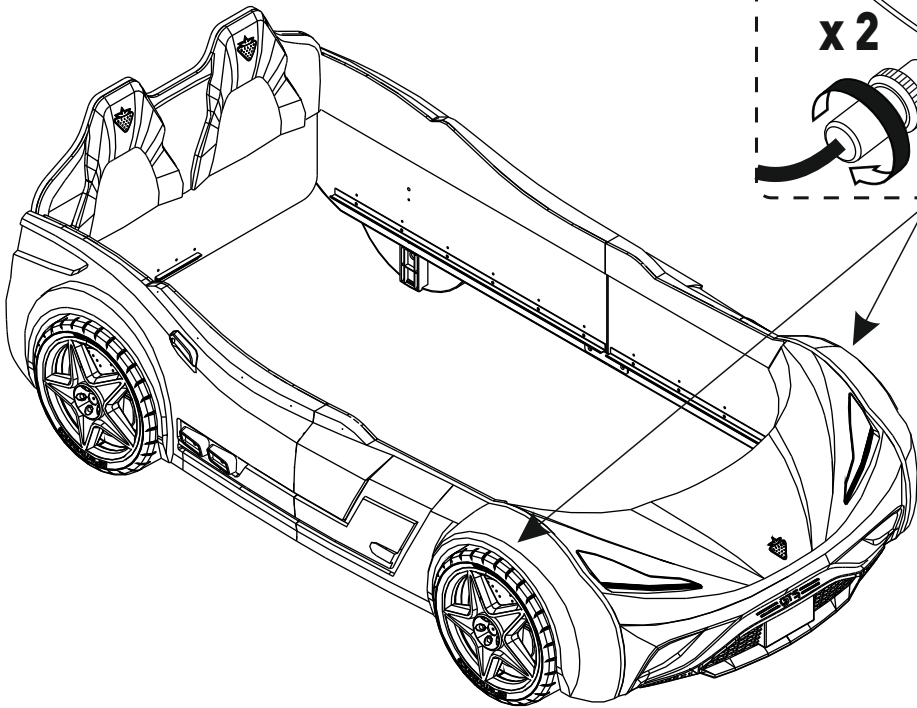

11

