

**20.76.1701.00**

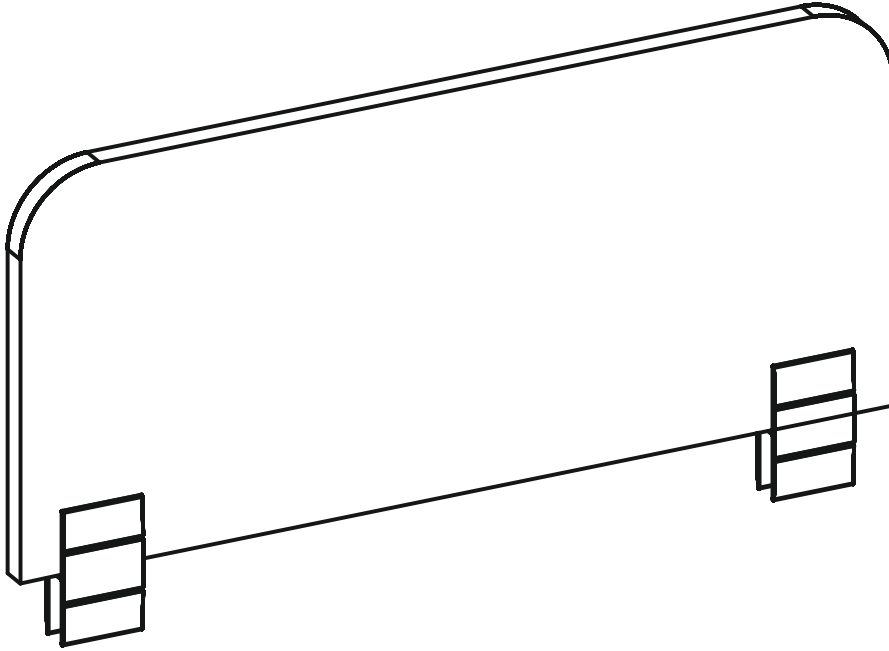

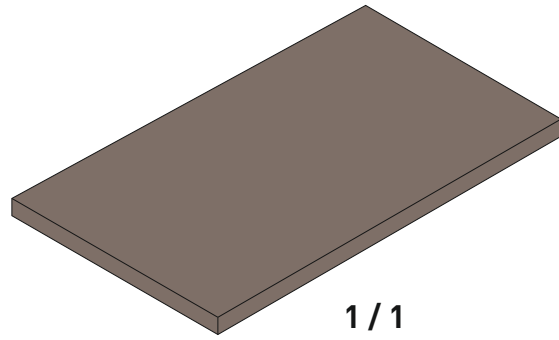
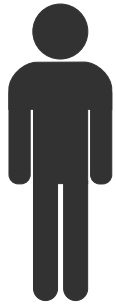

1 / 1

1 / 1

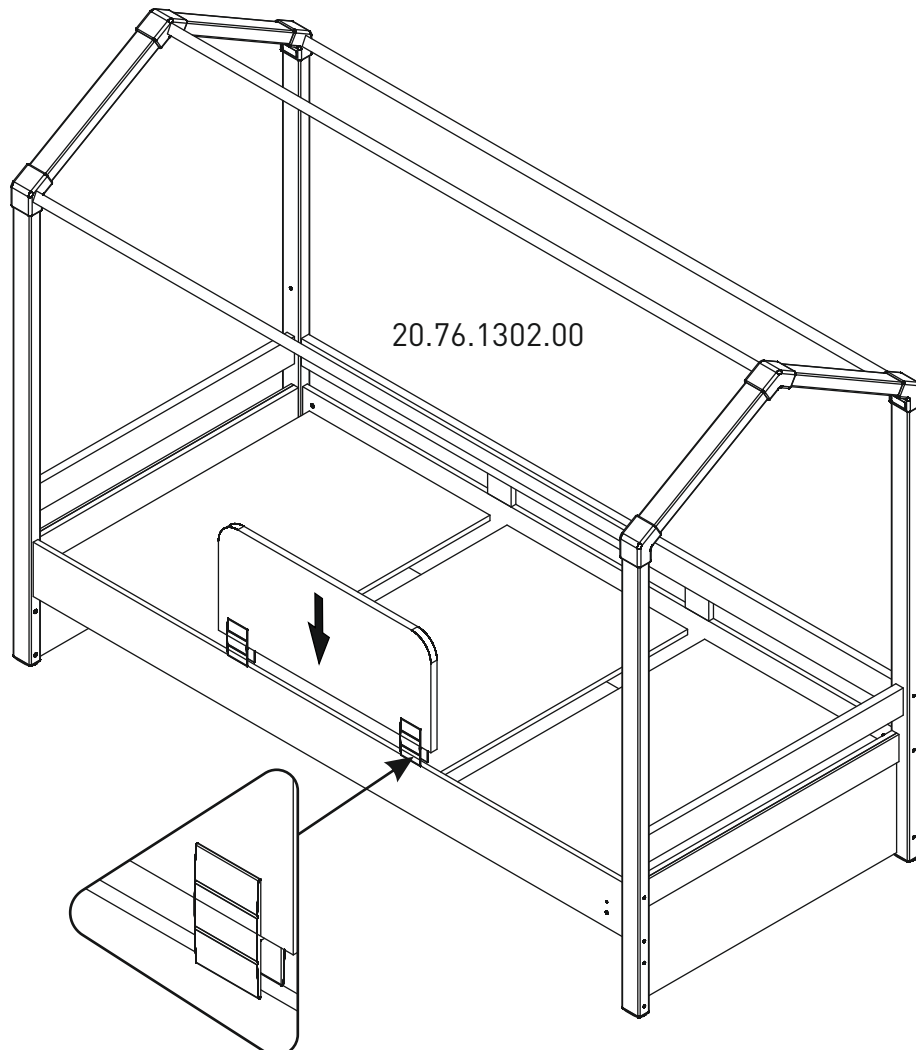
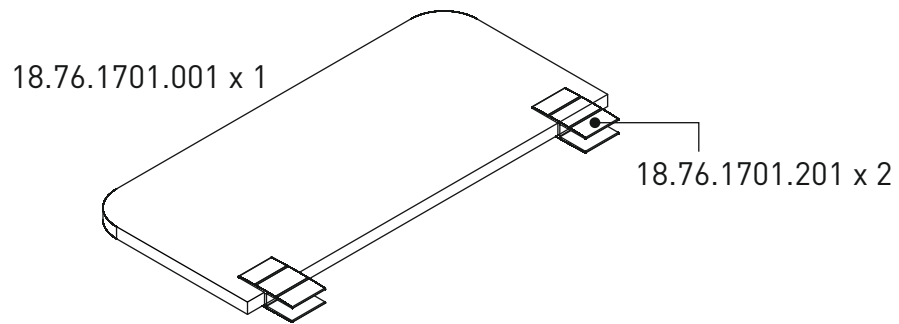

1