

**20.72.1303.00**

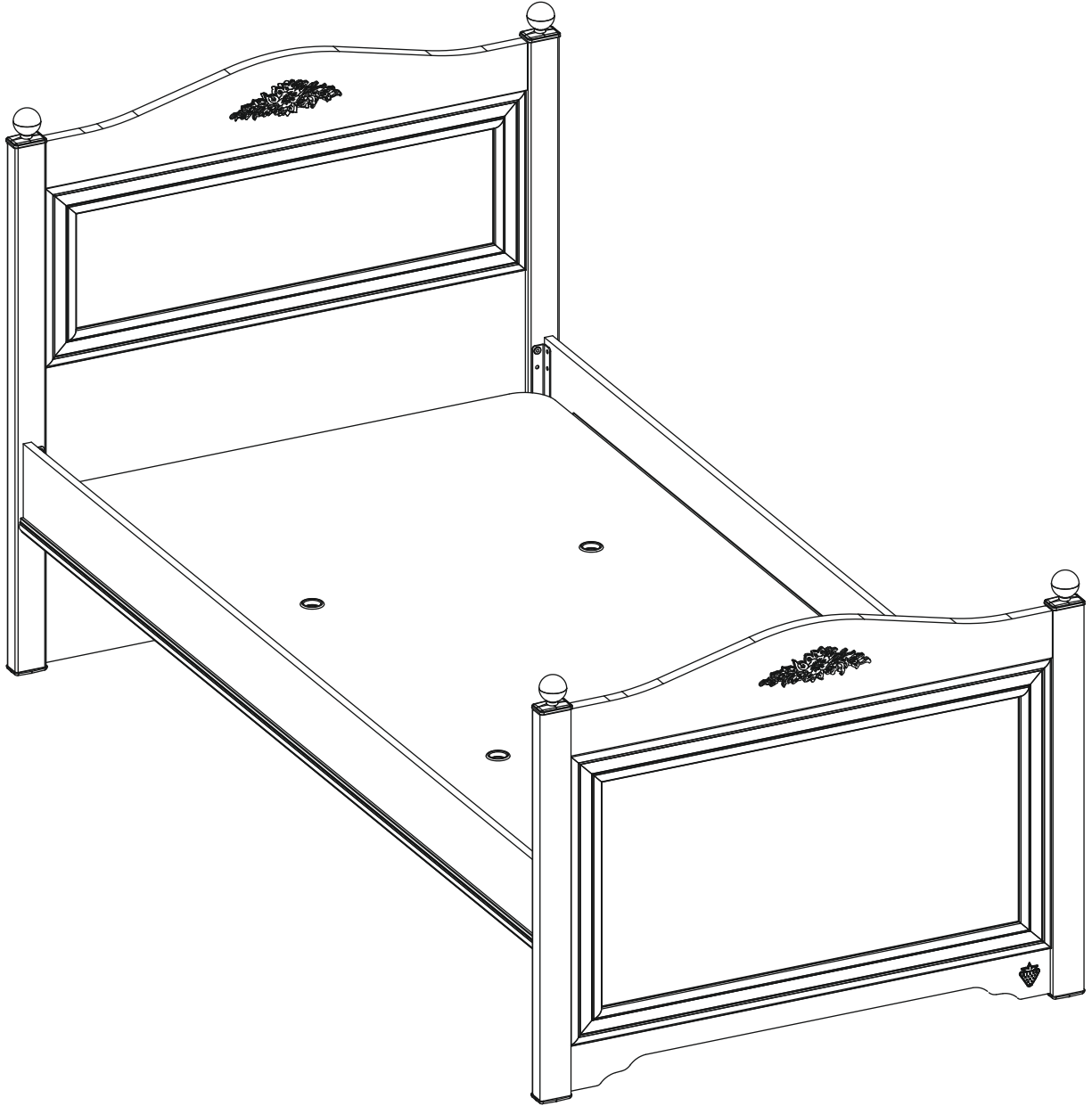

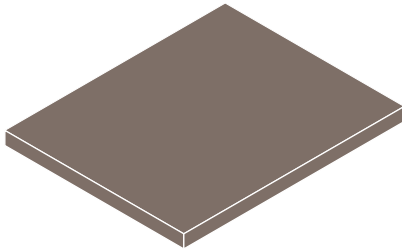

1 / 2

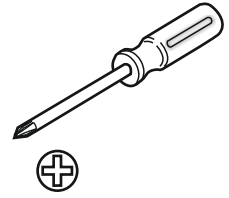
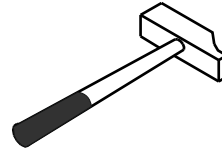
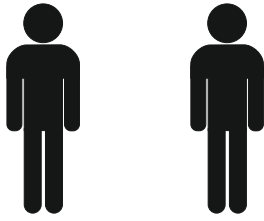
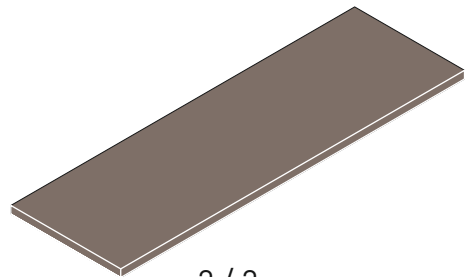

2 / 2



13.07.01.108 x 12

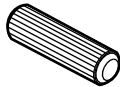

13.01.01.111 x 16



13.02.01.017 x 30



13.07.01.110 x 12



Ø10  
13.01.02.104 x 4



18.00.2000.208 x 2



M6X30  
13.03.01.029 x 4



M4X40  
13.03.01.117 x 4



13.07.01.101 x 4

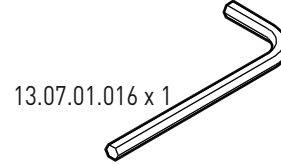

13.07.01.016 x 1

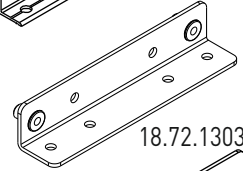

18.72.1303.202 x 2

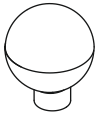

13.01.01.723 x 4



13.01.01.724 x 4



M6X13  
13.03.01.021 x 24



M6X20  
13.03.01.026 x 4



13.01.01.045 x 12

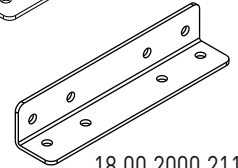

18.00.2000.211 x 2

2 / 1

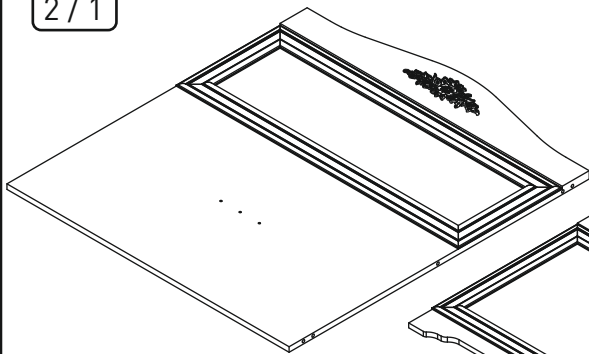

18.72.1303.001 x 1

18.72.1303.002 x 1

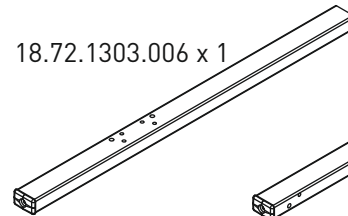

18.72.1303.006 x 1

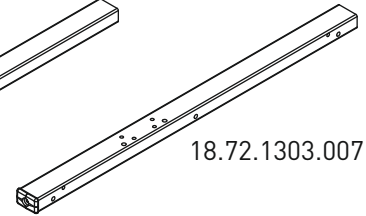

18.72.1303.007 x 1

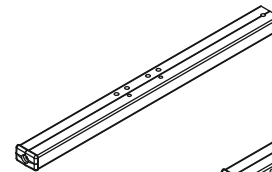

18.72.1303.009 x 1

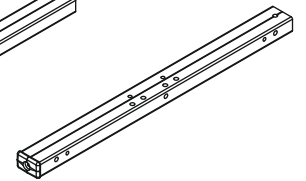

18.72.1303.008 x 1

2 / 2

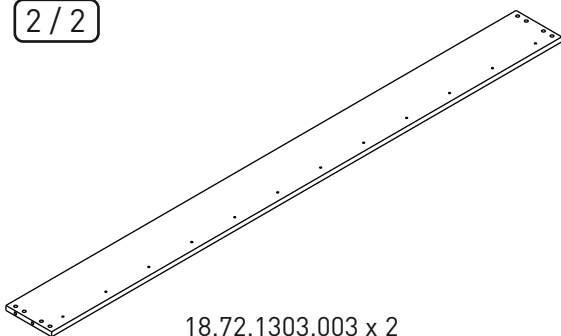

18.72.1303.003 x 2

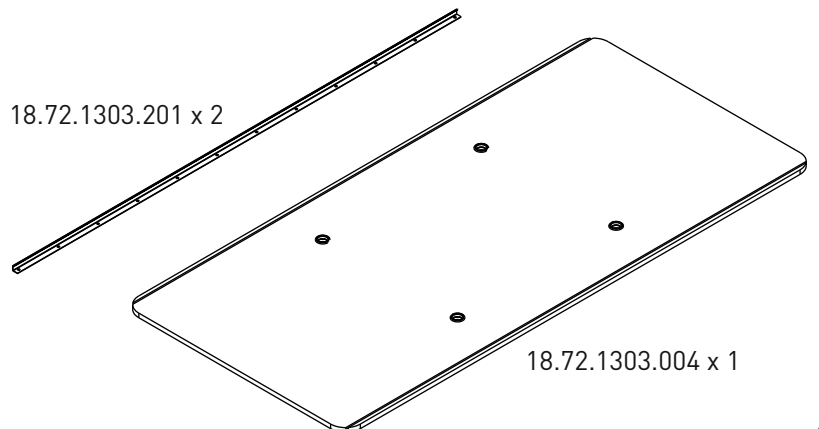

18.72.1303.201 x 2

18.72.1303.004 x 1

1

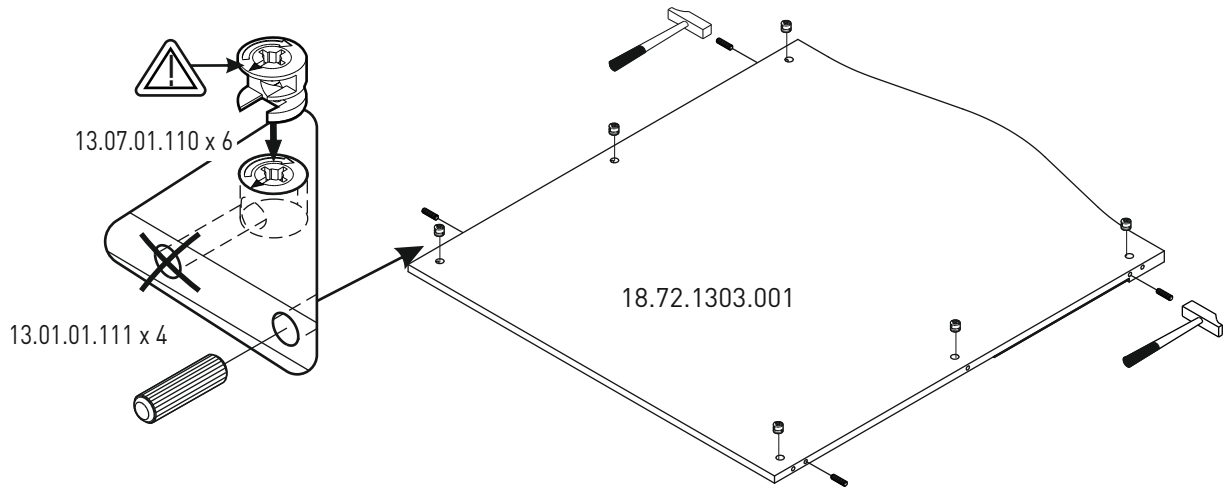

2

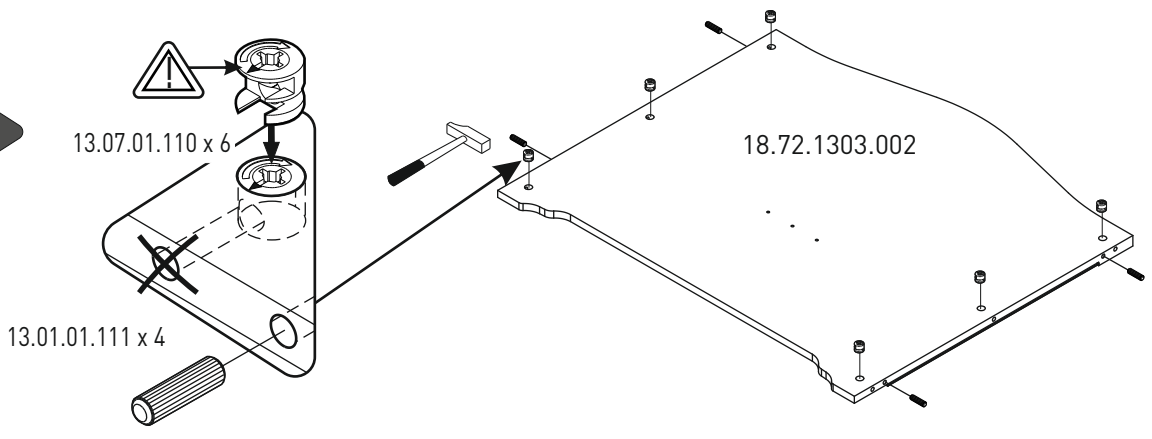

3

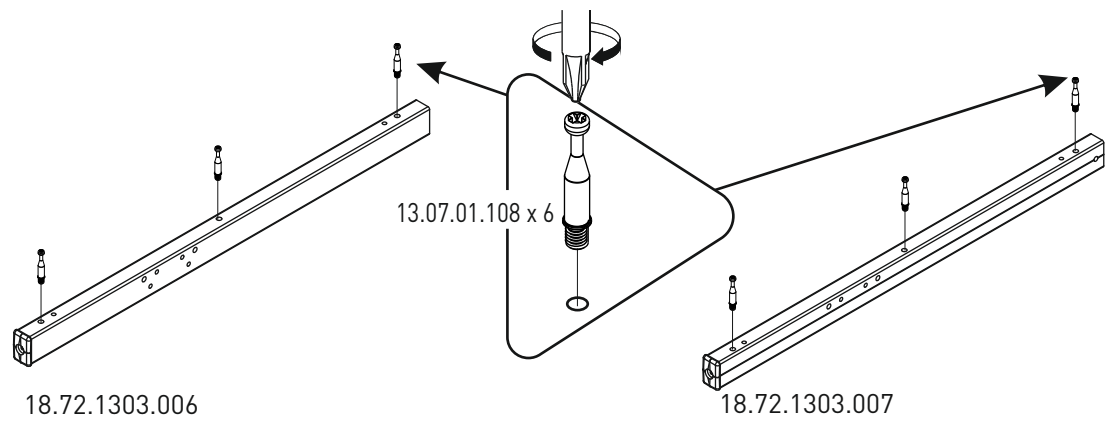

4

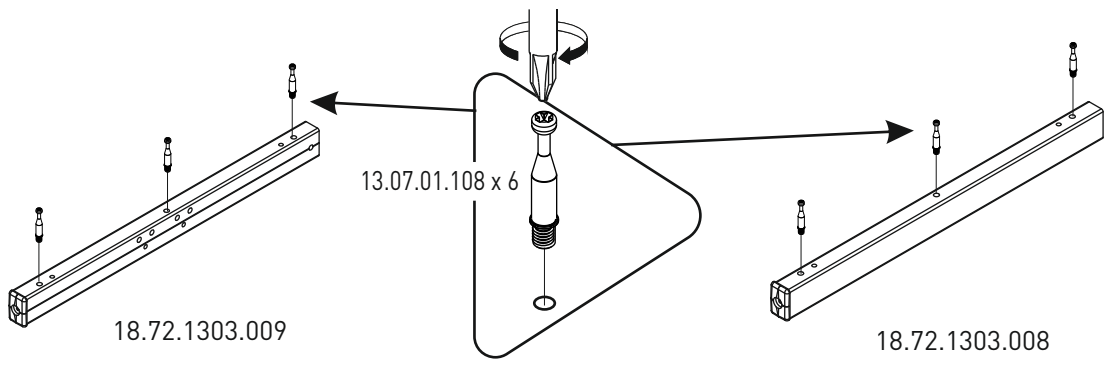

5

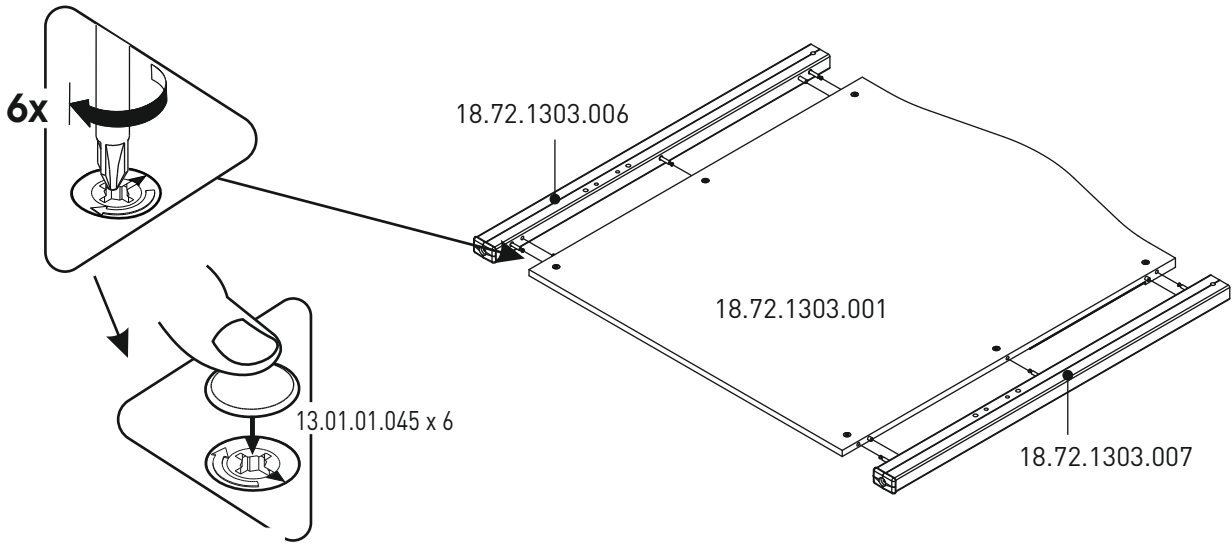

6

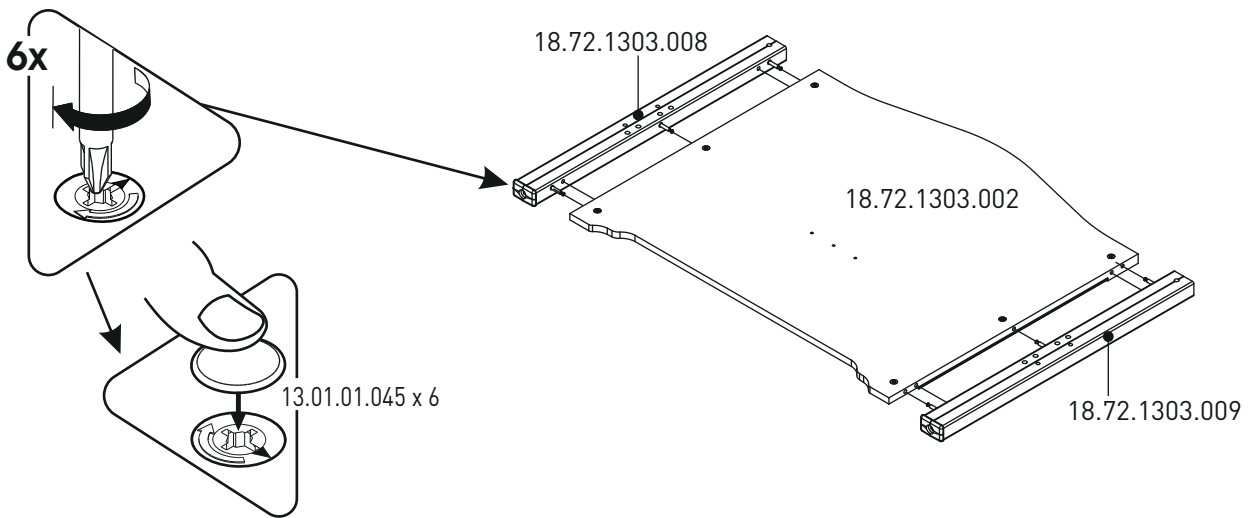

7

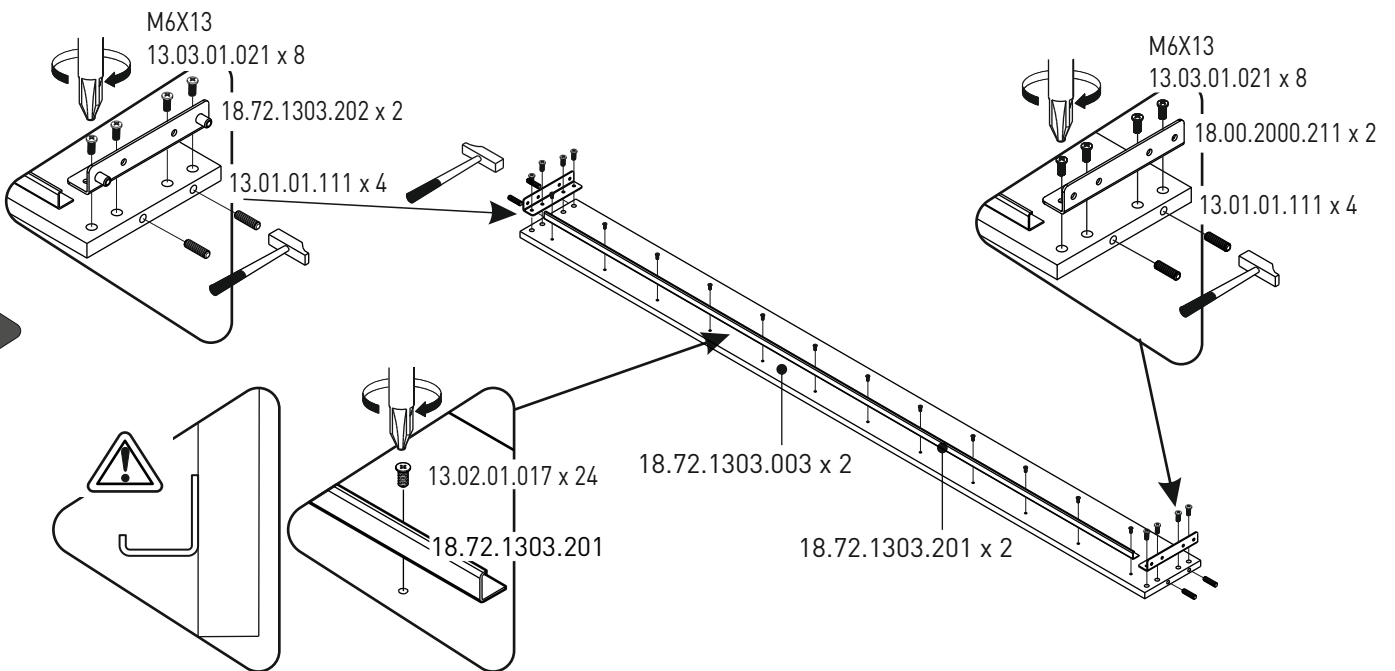



13.07.01.016 x 1

M6X30  
13.03.01.029 x 4

13.03.01.026 x 4  
M6X20

18.72.1303.003

18.00.2000.208 x 2

13.02.01.017 x 6

13.03.01.021 x 8  
M6X13

8

9

18.72.1303.004

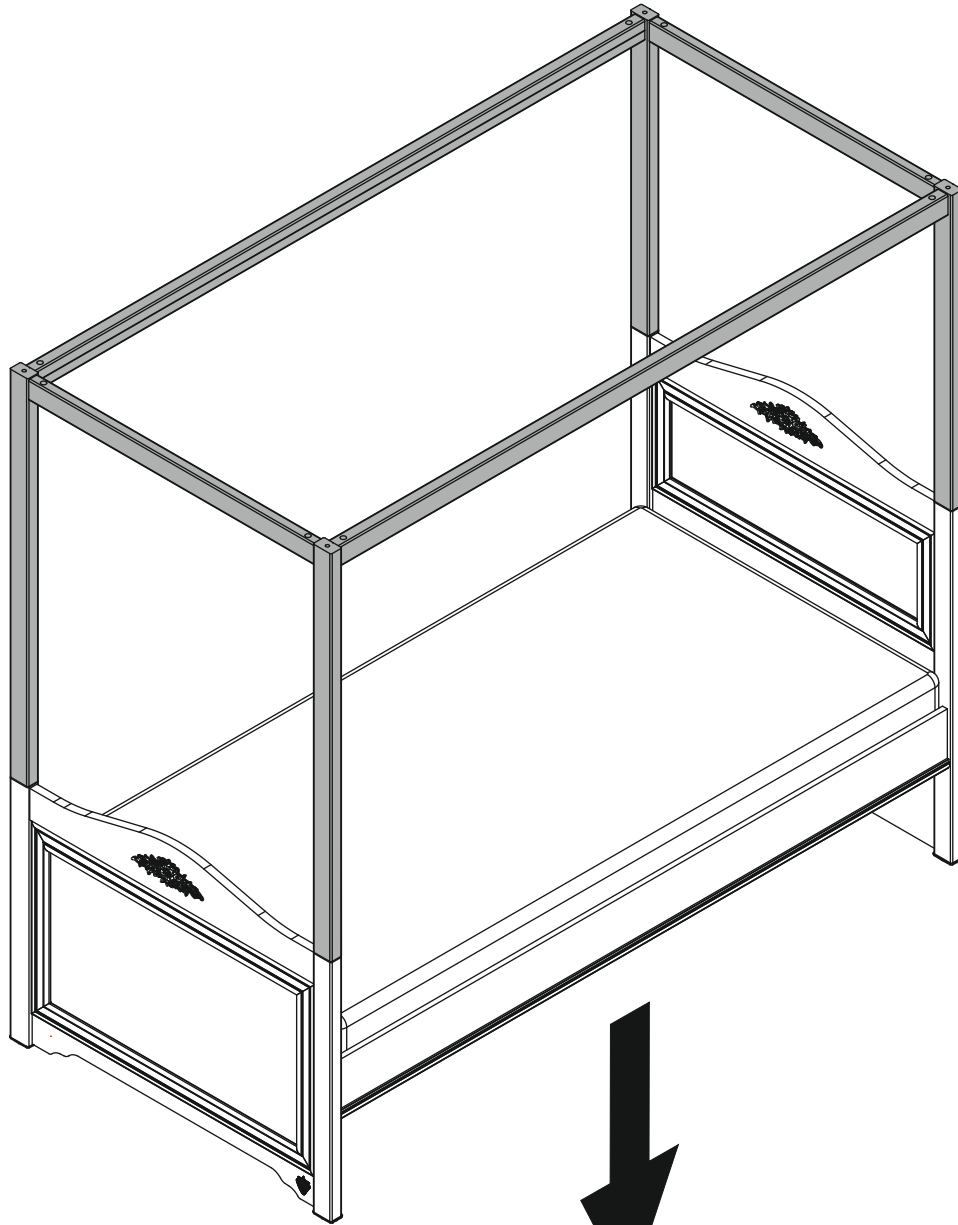

10

