

© 2018 Progressive Marketing, Inc.

FITTINGS

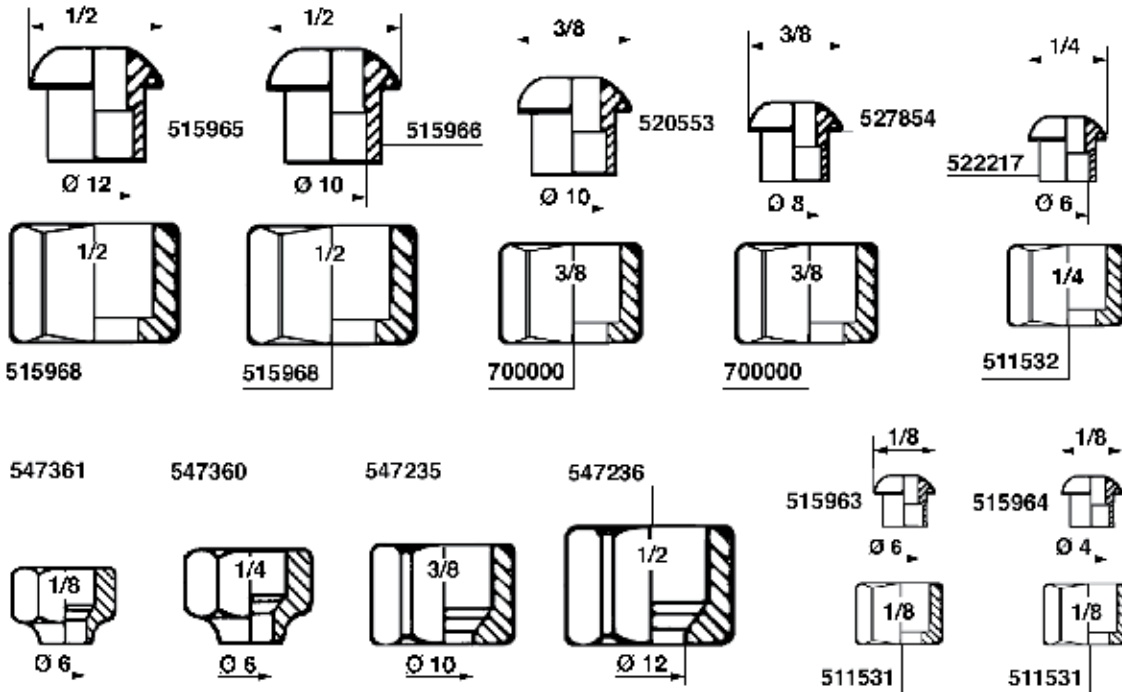
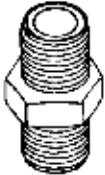
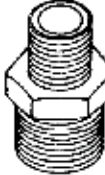
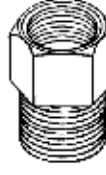

		
700023= 1/8M	700056= 1/8M - 1/4M	620399= 1/8F - 1/4M
700039= 1/4M	620581= 1/8M - 3/8M	700046= 1/8F - 3/8M
514901= 3/8M	700036= 1/4M - 3/8M	620398= 1/4F - 1/8M
700034= 1/2M	700035= 3/8M - 1/2M	700082= 1/4F - 3/8M
620401= 3/4M	700041= 3/8M - 3/4M	620582= 3/8F - 1/8M
	700098= 1/2M - 3/4M	700091= 3/8F - 1/4M
	700114= 1"M - 3/4M	700089= 3/8F - 3/8M
	620578= 1"M - 3/8M	700090= 3/8F - 1/2M
		700092= 1/2F - 3/8M
		700093= 3/4F - 3/8M
		700083= 3/4F - 1/2M

CONNECTION FITTINGS

Save time and headaches with these Euro/US crossover fittings, exclusively from Nuova Ricambi, USA!

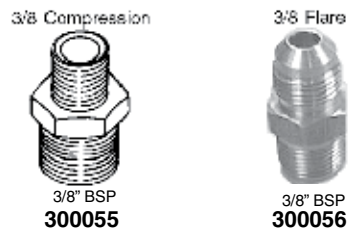
FEMALE PLUG

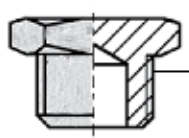

- 620580/1=1/8F
- 620580/2=1/4F
- 620580/3=3/8F
- 620580/4=1/2F

MALE PLUG

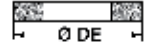
- 620579/1=1/8M
- 620579/2=1/4M
- 620579/3=3/8M
- 620579/4=1/2M

TEFLON GASKET

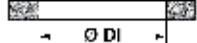
- 529010/1 = \varnothing DE 1/8
- 529010/2 = \varnothing DE 1/4
- 529010/3 = \varnothing DE 3/8
- 529010/4 = \varnothing DE 1/2
- 529010/5 = \varnothing DE 3/4

TEFLON GASKET

- 529011 = \varnothing DI 1/8
- 529012 = \varnothing DI 1/4
- 700330/T = \varnothing DI 3/8
- 634300 = \varnothing DI 1/2
- 529015 = \varnothing DI 3/4

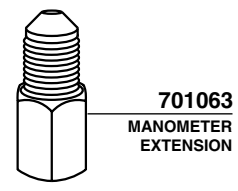
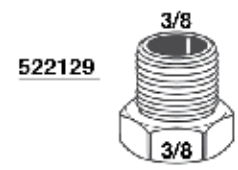
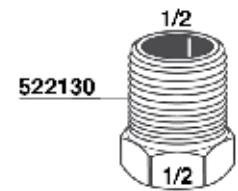
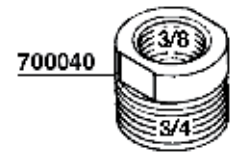



620550=1/8M
620551=1/4M
620552=3/8M
620553=1/2M



620554=1/8F
620555=1/4F
620556=3/8F
620557=1/2F



620558=1/8FFM
620559=1/4FFM
620560=3/8FFM
620561=1/2FFM



620583=1/8FMM
620584=1/4FMM



620585=1/8MMF
620586=1/4MMF



620562=1/8M
620563=1/4M
620564=3/8M
620565=1/2M



400226=1/8M-1/4M



620566=1/8F
620567=1/4F
620568=3/8F
620569=1/2F



620570=1/8MF
620571=1/4MF
620572=3/8MF
620573=1/2MF



410760=1/8M Ø 4
408858=1/8M Ø 6

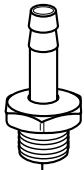

700043
6mm - 1/8



700043/M
6mm - 1/8

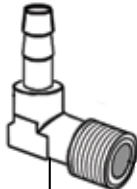

700043/C
6mm - 1/8

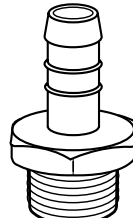

700033
12mm - 1/2

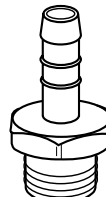

700002
8mm - 3/8

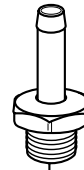

700053
6mm - 1/8

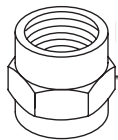

620574= 1/8F
620410= 1/4F
620411= 3/8F
620575= 1/2F

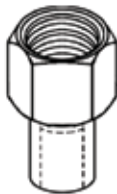

620576=1/8F-1/4F
620412=1/4F-3/8F
620577=3/8F-1/2F



700022
mt.12x12mmx0.07mm