

460020
HEAD REBUILD KIT

460000	518543
460000/T	518608
460002	520546
460003	524467
460006	524552/C
460010	602576 (x2)
460085	700325
513836/T (x3)	700883
517849	703008

VIBIEMME

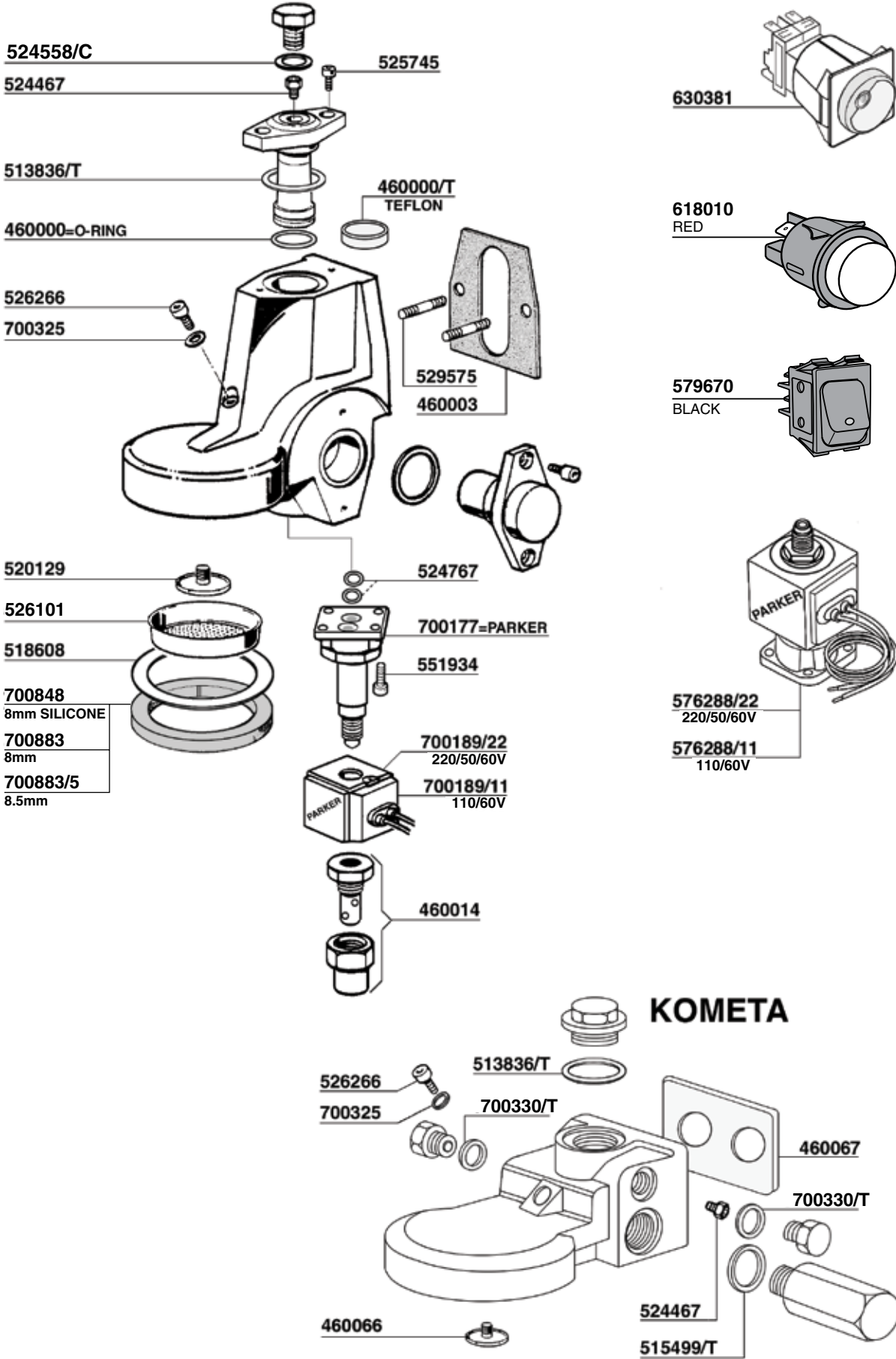

VIBIEMME

© 2021 Progressive Marketing, Inc.

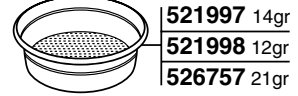
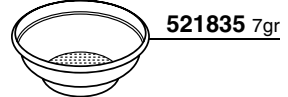
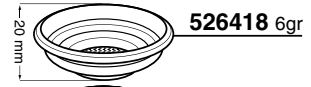
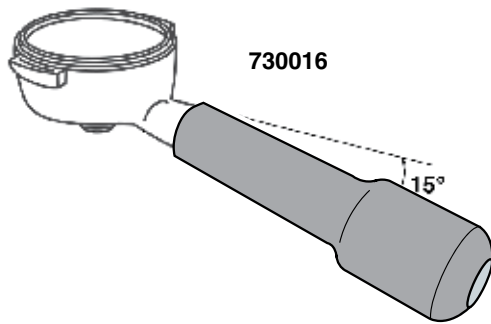
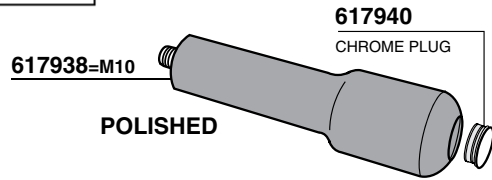
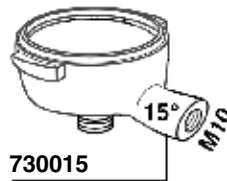
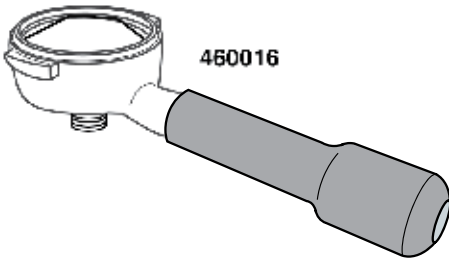
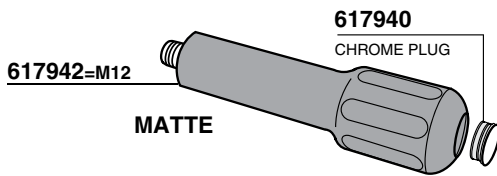
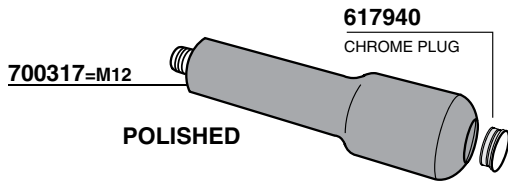
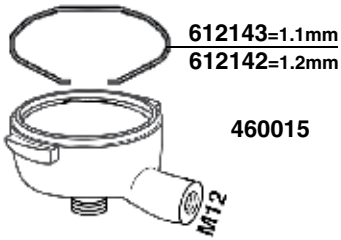

521998 12gr

526757 21gr

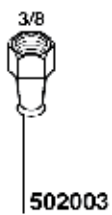
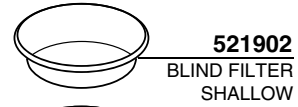

VIBIEMME

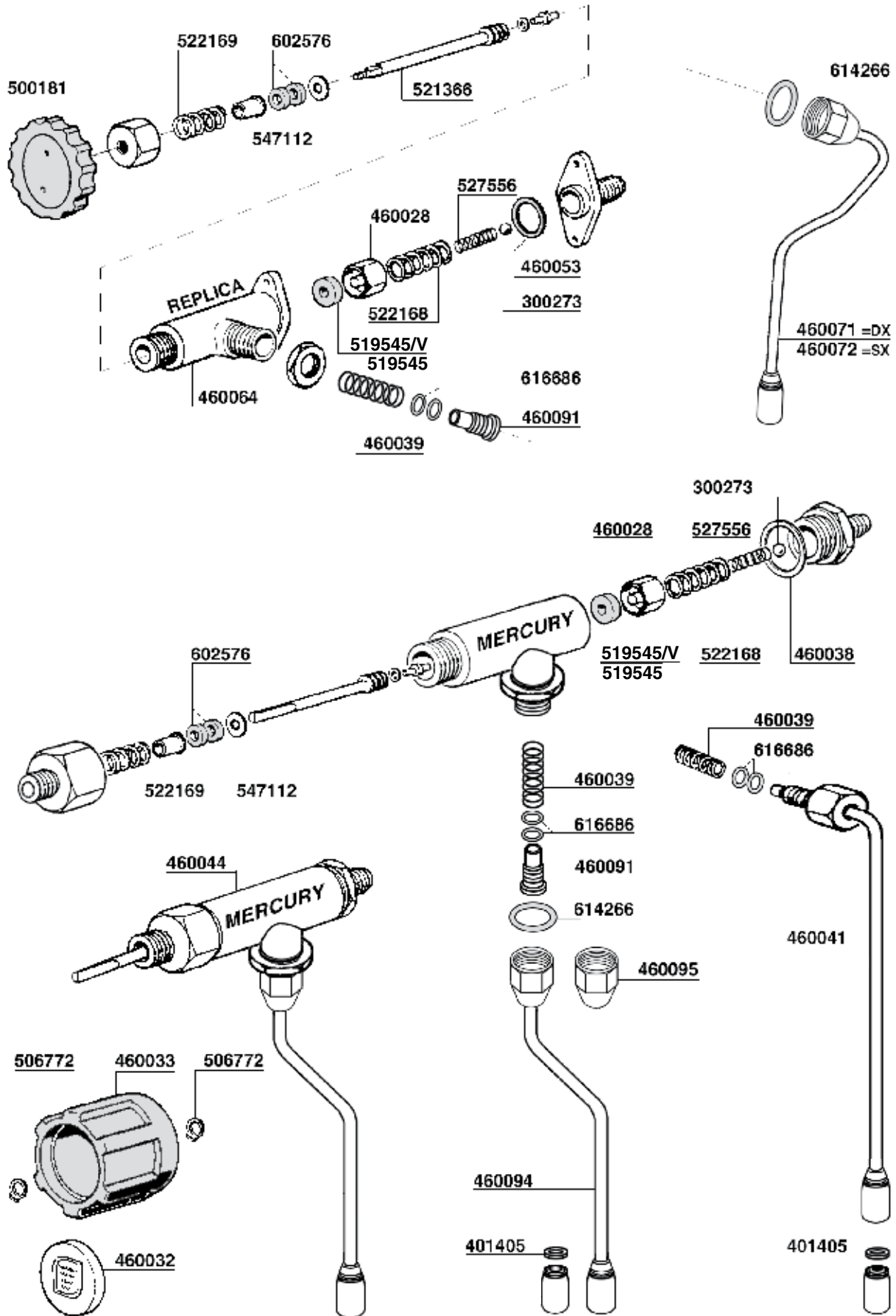

VIBIEMME

© 2021 Progressive Marketing, Inc.

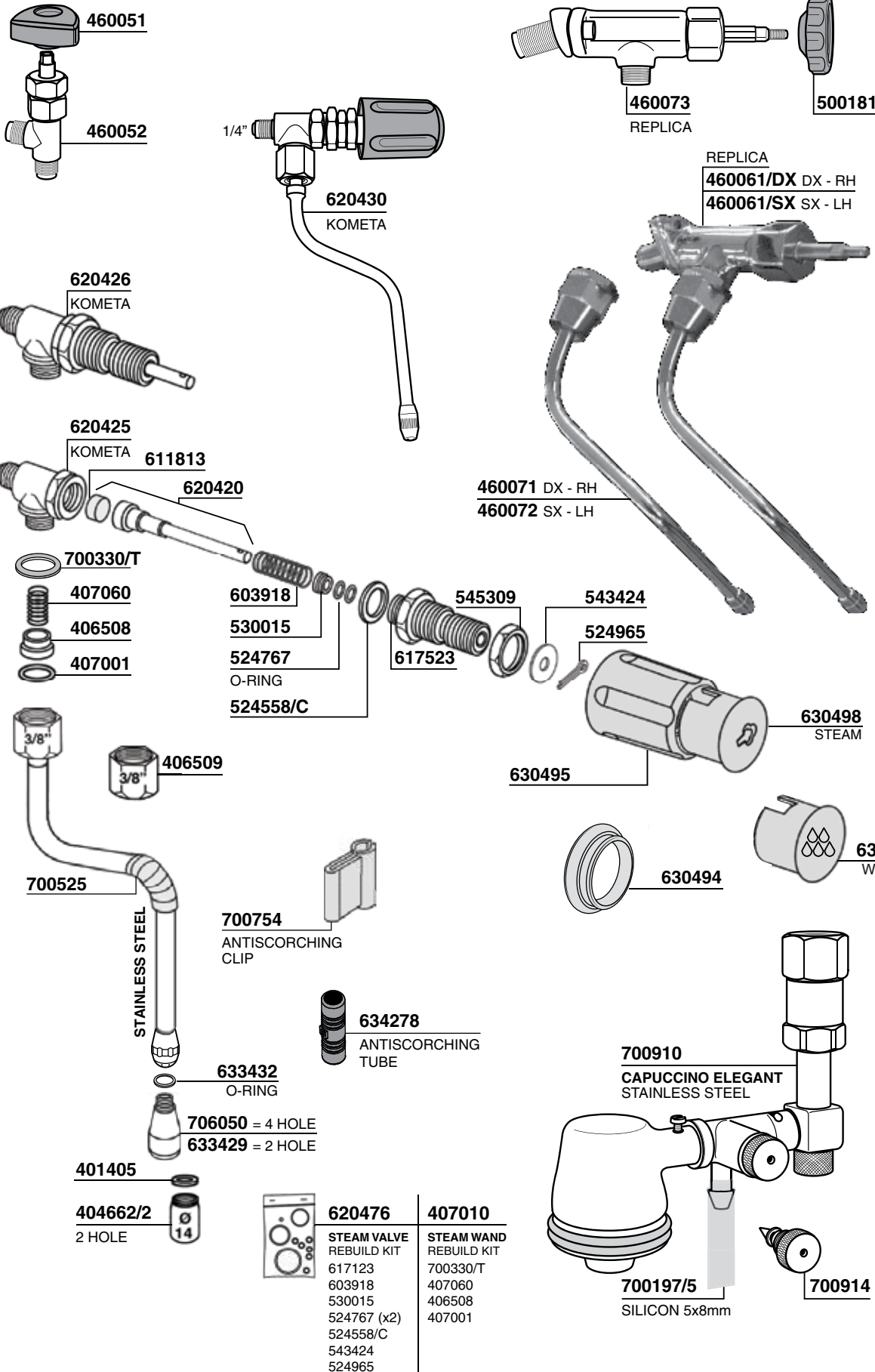

© 2021 Progressive Marketing, Inc.

VIBIEMME

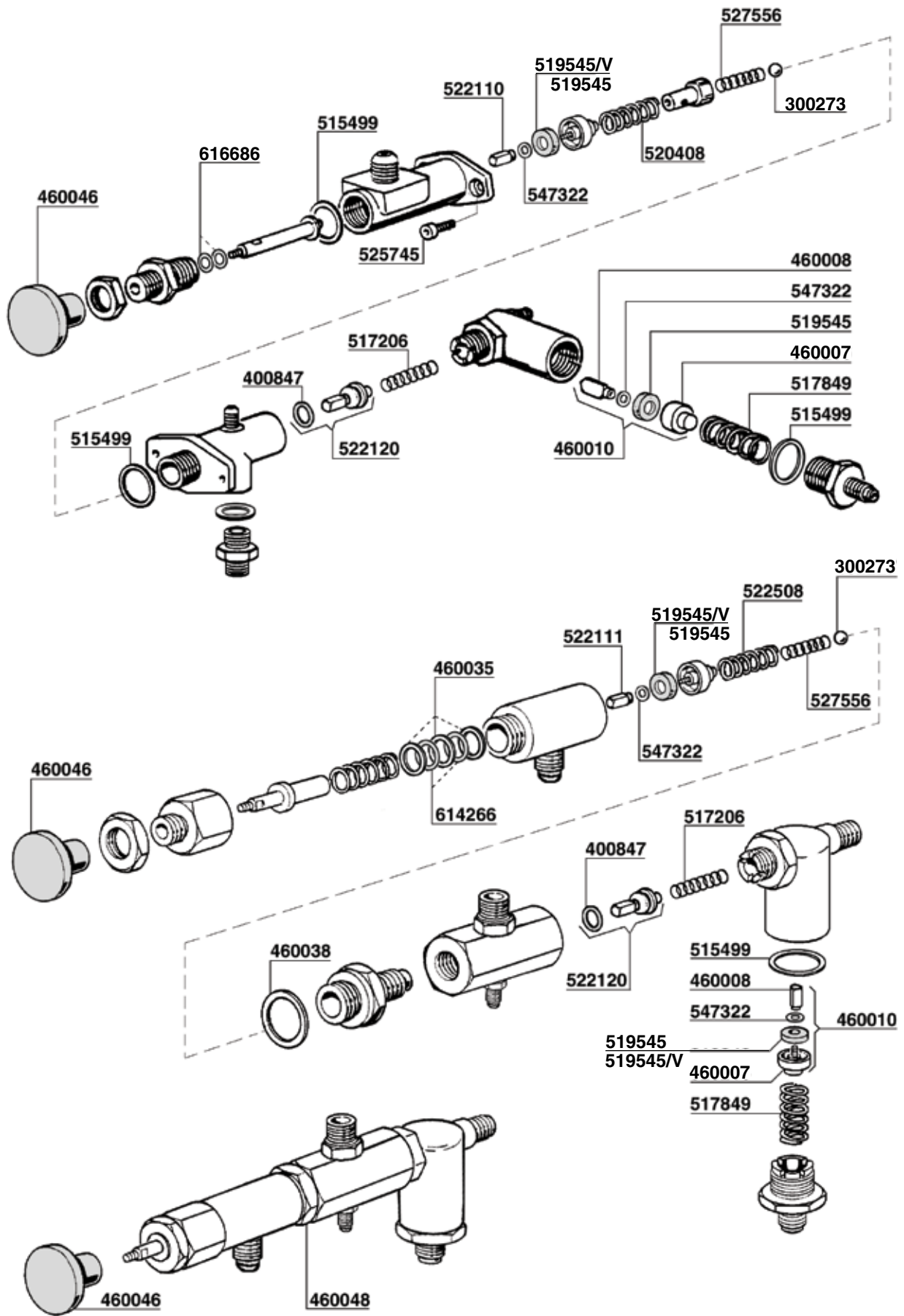

VIBIEMME

© 2021 Progressive Marketing, Inc.

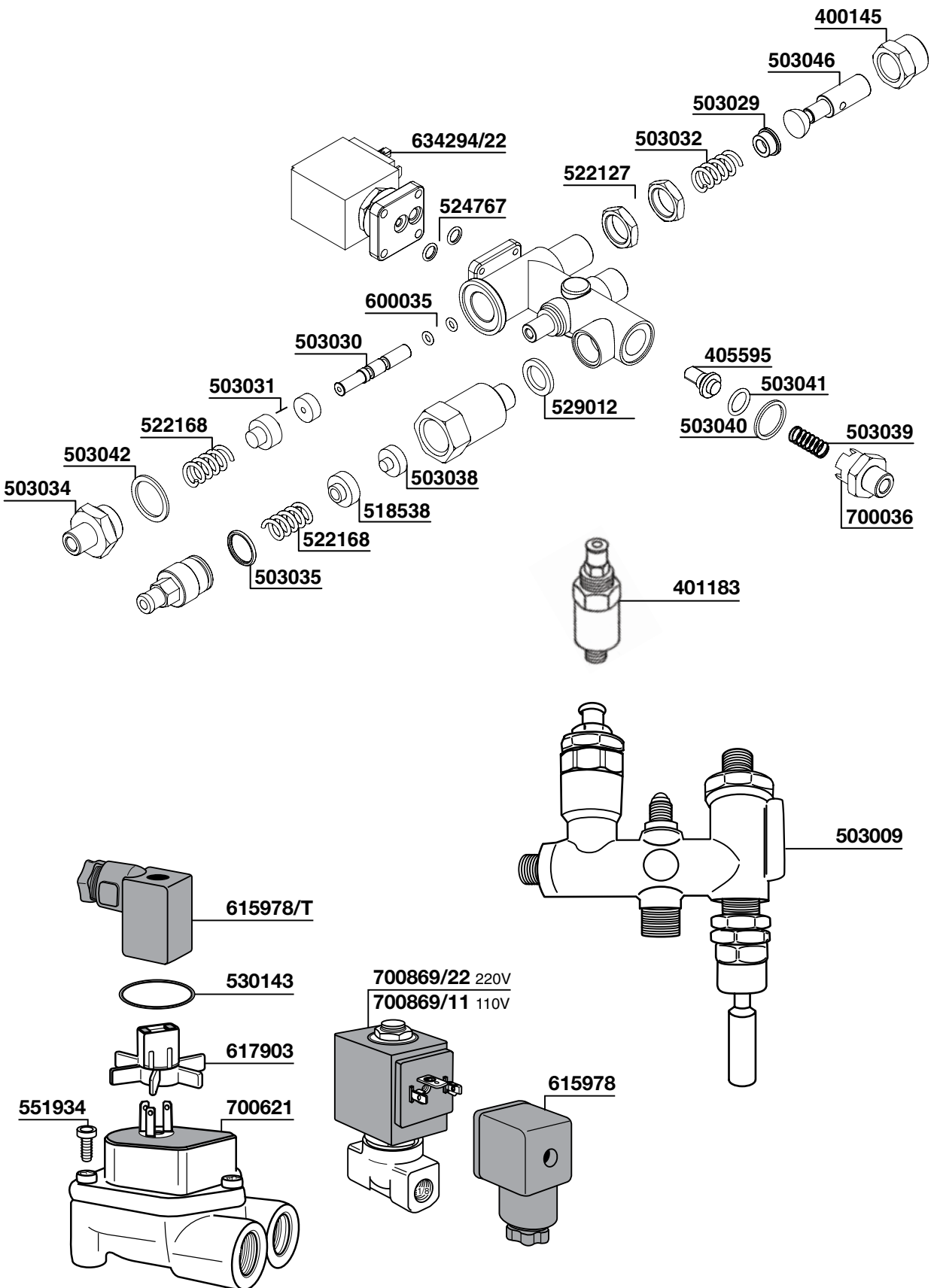

© 2021 Progressive Marketing, Inc.

VIBIEMME

VIBIEMME

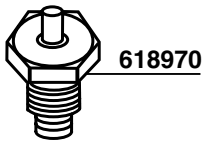

618970

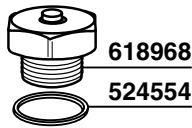

618968
524554

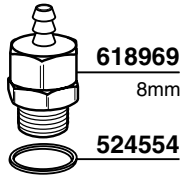

618969
8mm
524554

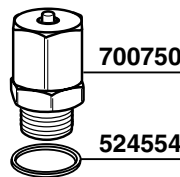

700750
524554

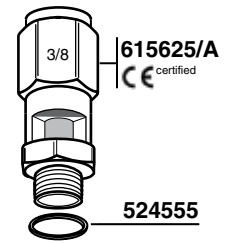

3/8
615625/A
certified
CE
524555

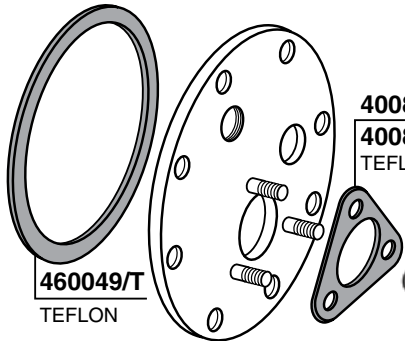

460049/T
TEFLON

400819
400819/T
TEFLON

- 400614 1GR 220V 1800W
- 400615 2GR 220V 3000W
- 401834 2GR 220V 3500W
- 400615/38 2GR 380V 3000W
- 460059 MINIMAX 2GR 220V 2700W 250mm
- 400616 3GR 220V 4000W
- 400617 3/4GR 220V 5000W



400826/T

- 400613 1.25" 220V 2000W 170mm
- 700858/11 1.25" 110V 1500W 140mm
- 700858/22 1.25" 220V 1500W 140mm

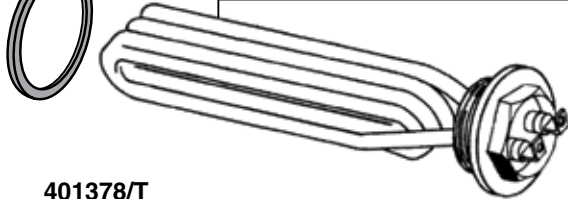

401378/T
TEFLON

- 401911 1" 220V 1350W 135mm
- 401912 1" 110V 1350W 135mm

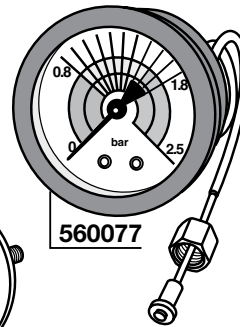
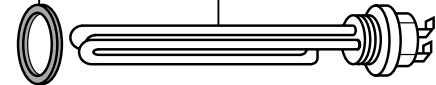

560077

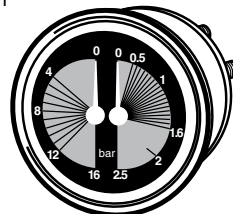

460050

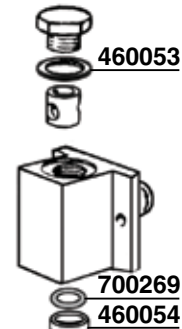

460053
700269
460054



460069 1GR COMPACT 2GR
460068 2GR

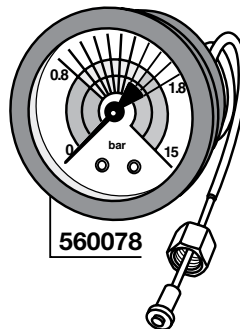

560078

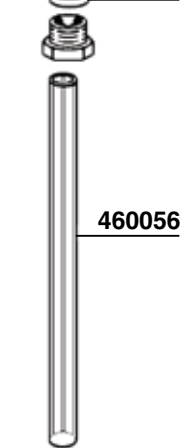

460056

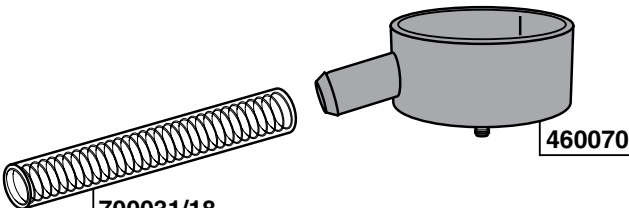

700031/18
ELISPIR 18x25mm

460070

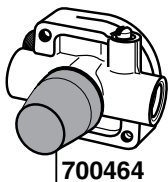

700464

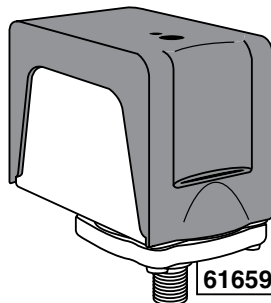

616597 CE/UL

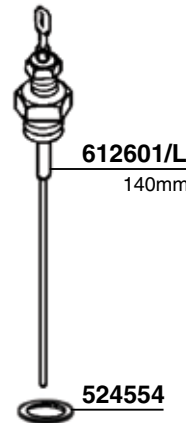

612601/L
140mm

524554

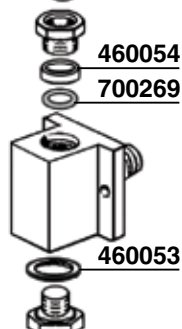

460054
700269
460053

VIBIEMME

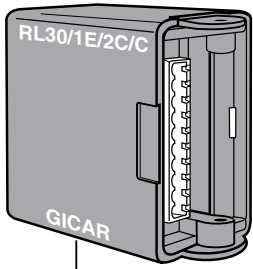

460062/22 220V
460062/11 110V



620709/10
CONNECTOR 10 PIN

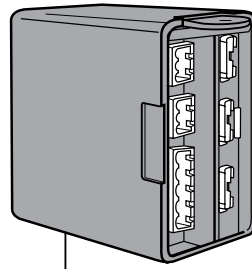

460075/22 220V
460075/11 110V
KOMETA

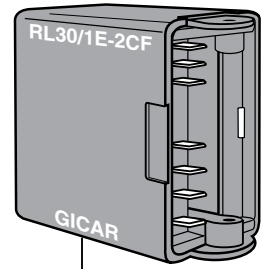

700737/22 220V
700737/11 110V

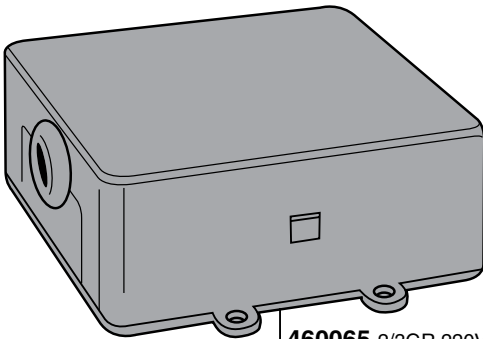

460065 2/3GR 220V
GICAR 3D

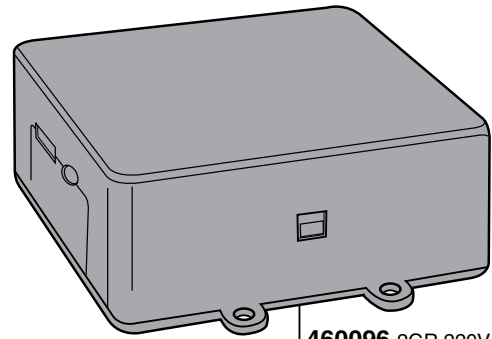

460096 2GR 220V
GICAR 3D5

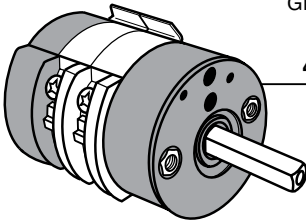

460093

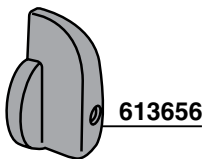

613656

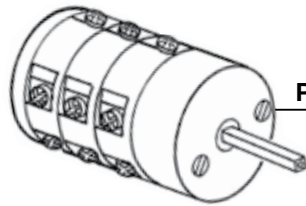

P4 - P6 615424

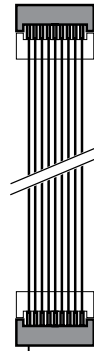

620714
8 pin 800mm

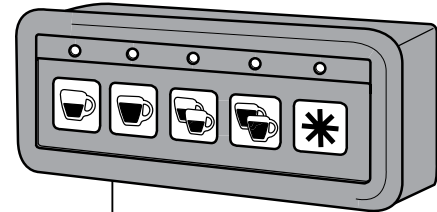

620702 1GR 220V
TOUCH PAD + ELECTRONIC BOX

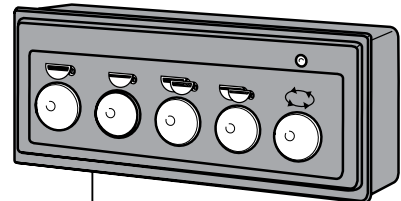

460092
TOUCH PAD

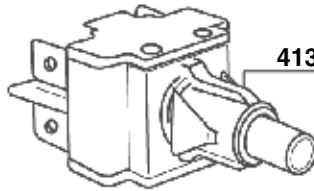

413706

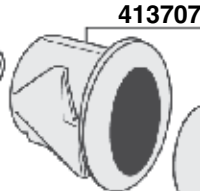

413707



413708

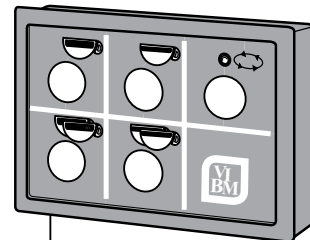

460074 KOMETA
TOUCH PAD

© 2021 Progressive Marketing, Inc.

VIBIEMME