

DO NOT SCALE FROM DRAWING. IF IN DOUBT: ASK

UNLESS OTHERWISE SPECIFIED, ALL DIMENSIONS ARE IN MILLIMETRES

BEWARE OF 100mm MEASURING ERROR

TANK DATA	
TANK CONTENTS:	ADBLUE
DESIGNED TO:	AS1940
BUILT TO:	AS1692
CORROSION ALLOW.	0mm
GROSS VOLUME:	12,105L
HYD.TEST PRESSURE:	21KPa
SAFE FILL LEVEL	11,500L
N.D.T.	Refer fabrication & assembly plan
TOTAL MASS:	3205kg

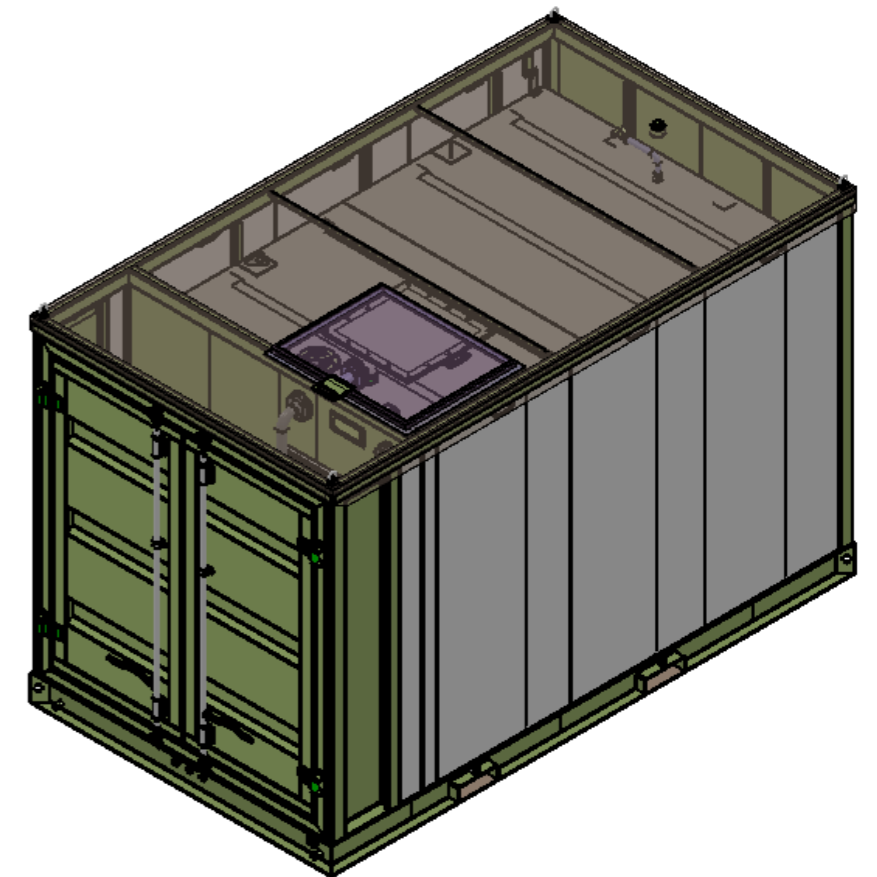
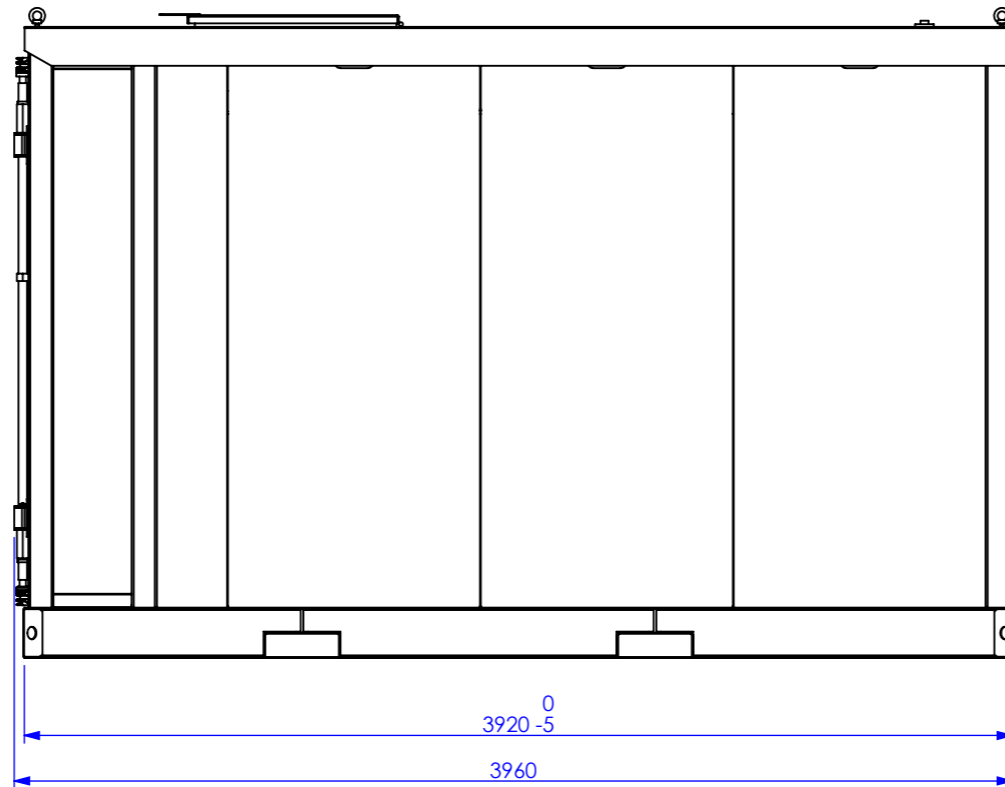
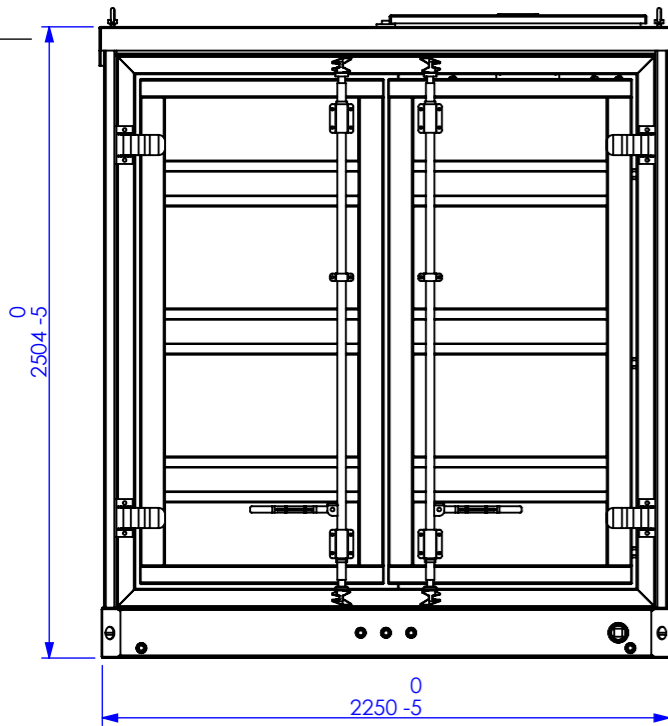
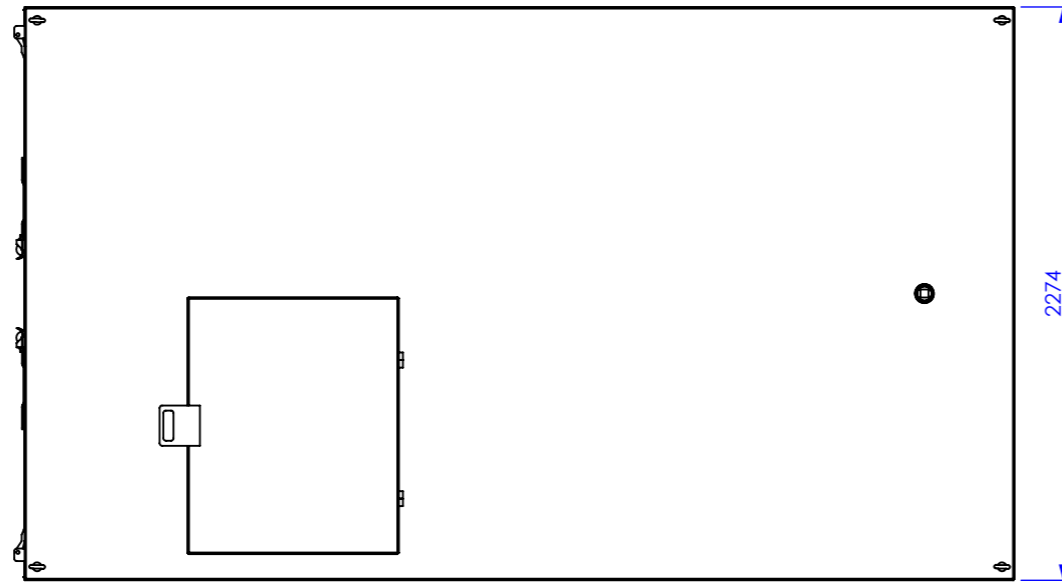

External Tank Material : Q235
 Adblue Tank Material : SS304

THIRD ANGLE PROJECTION	
NAME	DATE
DRAWN	2015/6/19
CHK'D	
APPV'D	



TOLERANCE U.N.O.
 0 = -1.0
 0.0 = -0.4
 0.00 = -0.1
 WEIGHT: 3205 Kg

DWG NO. / PART NO. ADBLUE AB-11 11,000L		JOB NO.
LIQUIP:		
TITLE:		SHEET SIZE A3
SCALE: N.T.S.		REVISION
SHEET 1 OF 3		

DO NOT SCALE FROM DRAWING. IF IN DOUBT: ASK

UNLESS OTHERWISE SPECIFIED, ALL DIMENSIONS ARE IN MILLIMETRES

BEWARE OF 100mm MEASURING ERROR

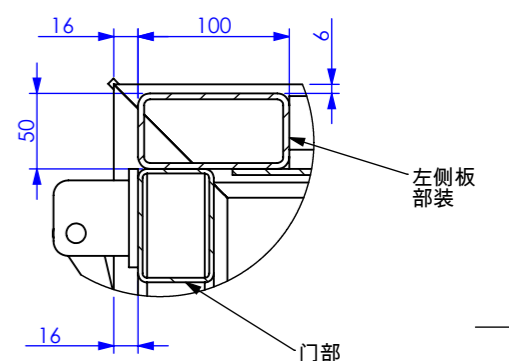
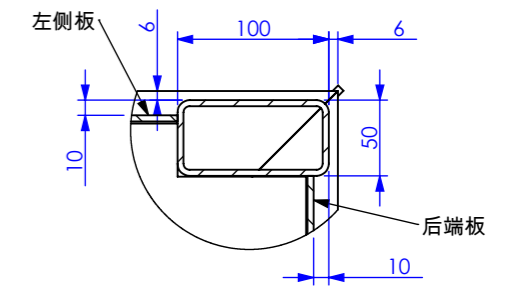
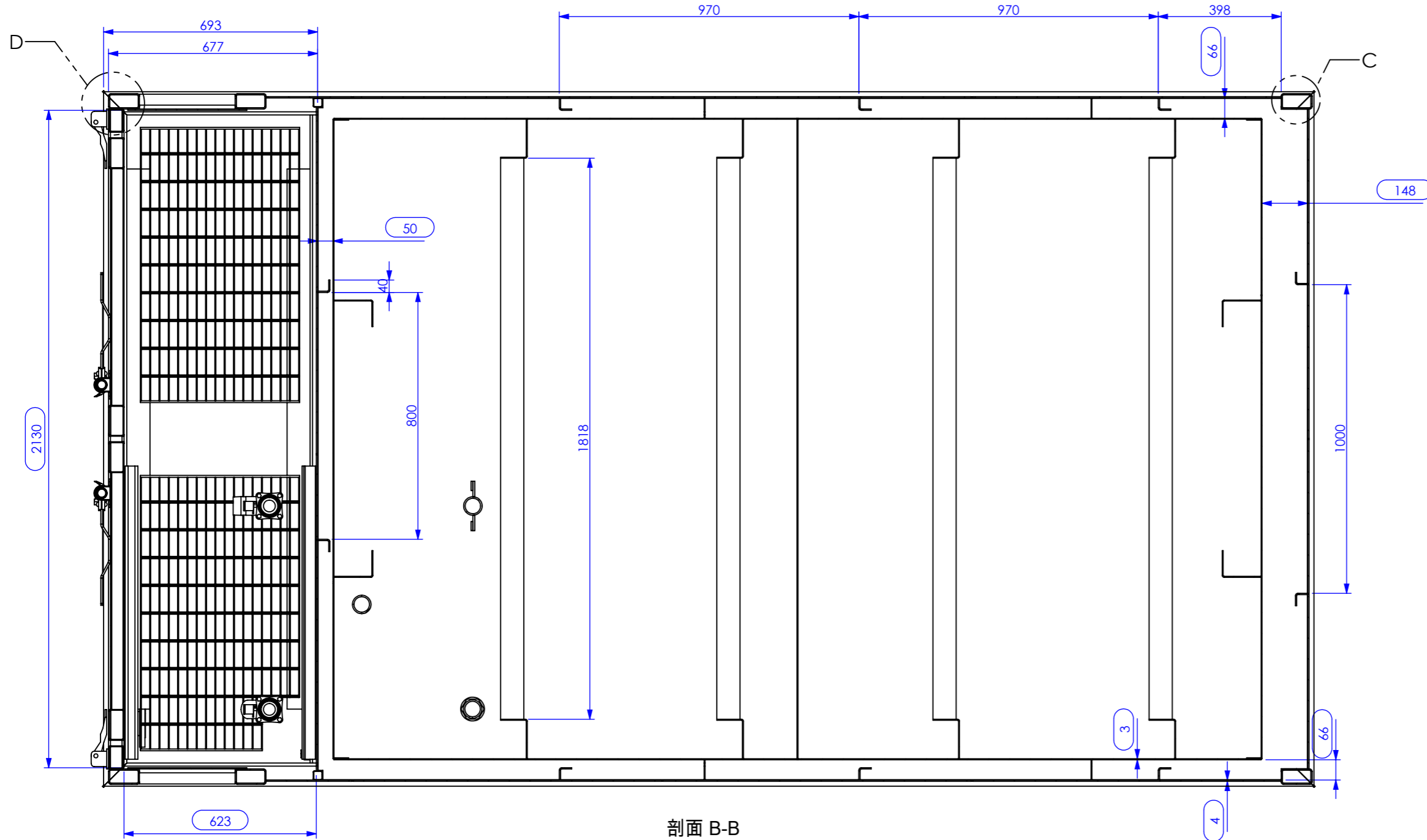

剖面 B-B

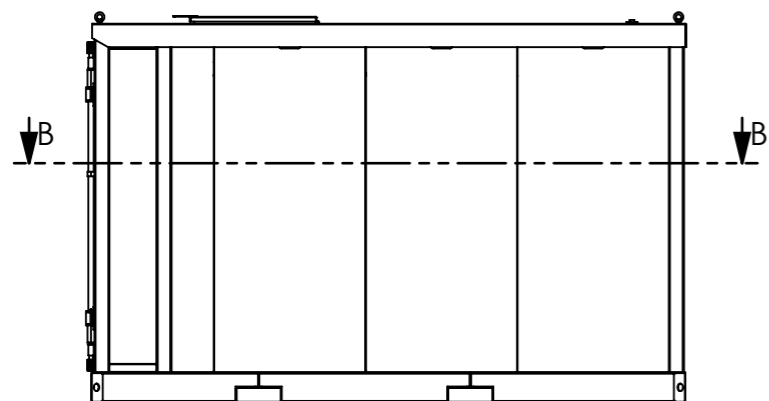

THIRD ANGLE PROJECTION		
NAME	DATE	
DRAWN	2015/6/19	
CHK'D		
APPV'D		TOLERANCE U.N.O. 0 = -1.0 0.0 = -0.4 0.00 = -0.1

DWG NO. / PART NO. ADBLUE AB-11 11,000L		JOB NO.
LIQUIP:		
TITLE:		
SCALE: N.T.S.		SHEET 2 OF 3

SHEET SIZE A3	
REVISION	

DO NOT SCALE FROM DRAWING. IF IN DOUBT: ASK

UNLESS OTHERWISE SPECIFIED, ALL DIMENSIONS ARE IN MILLIMETRES

BEWARE OF 100mm MEASURING ERROR

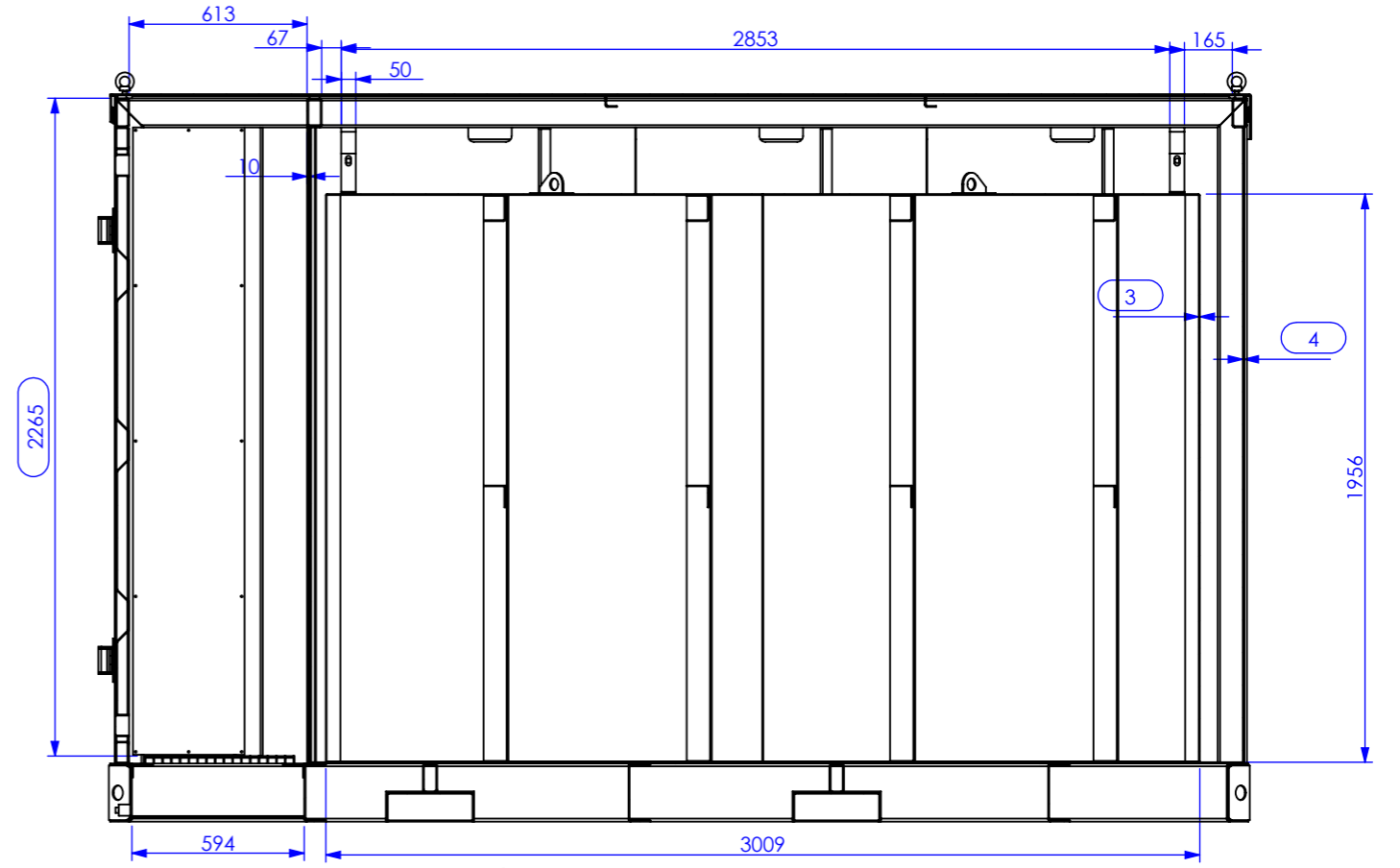
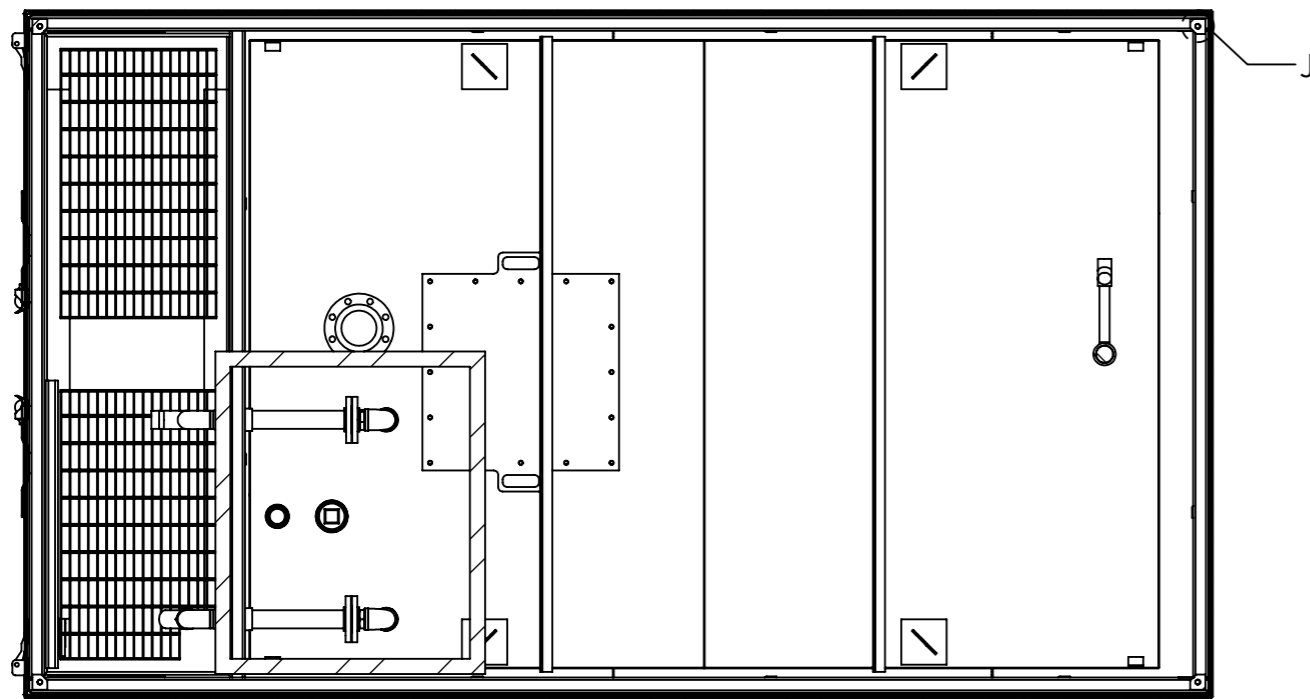

H-H

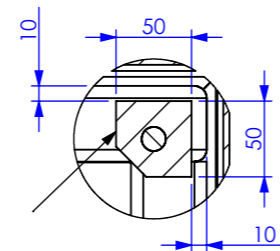
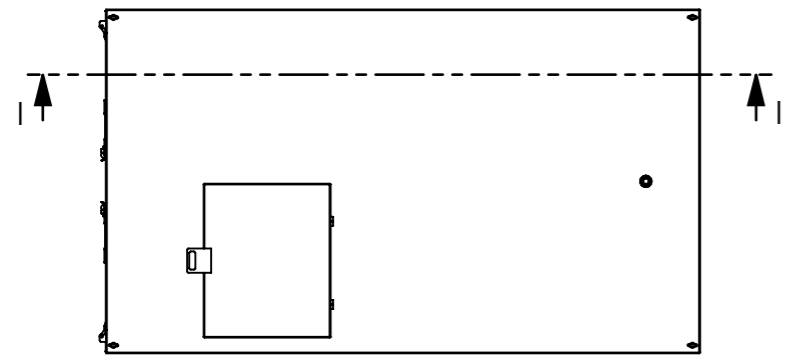

J

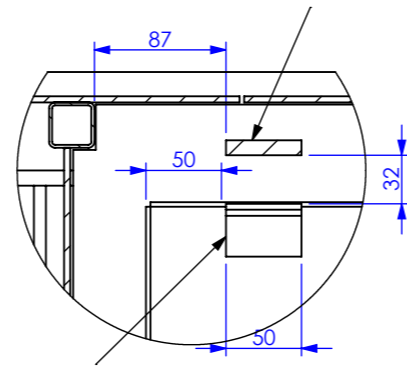

L

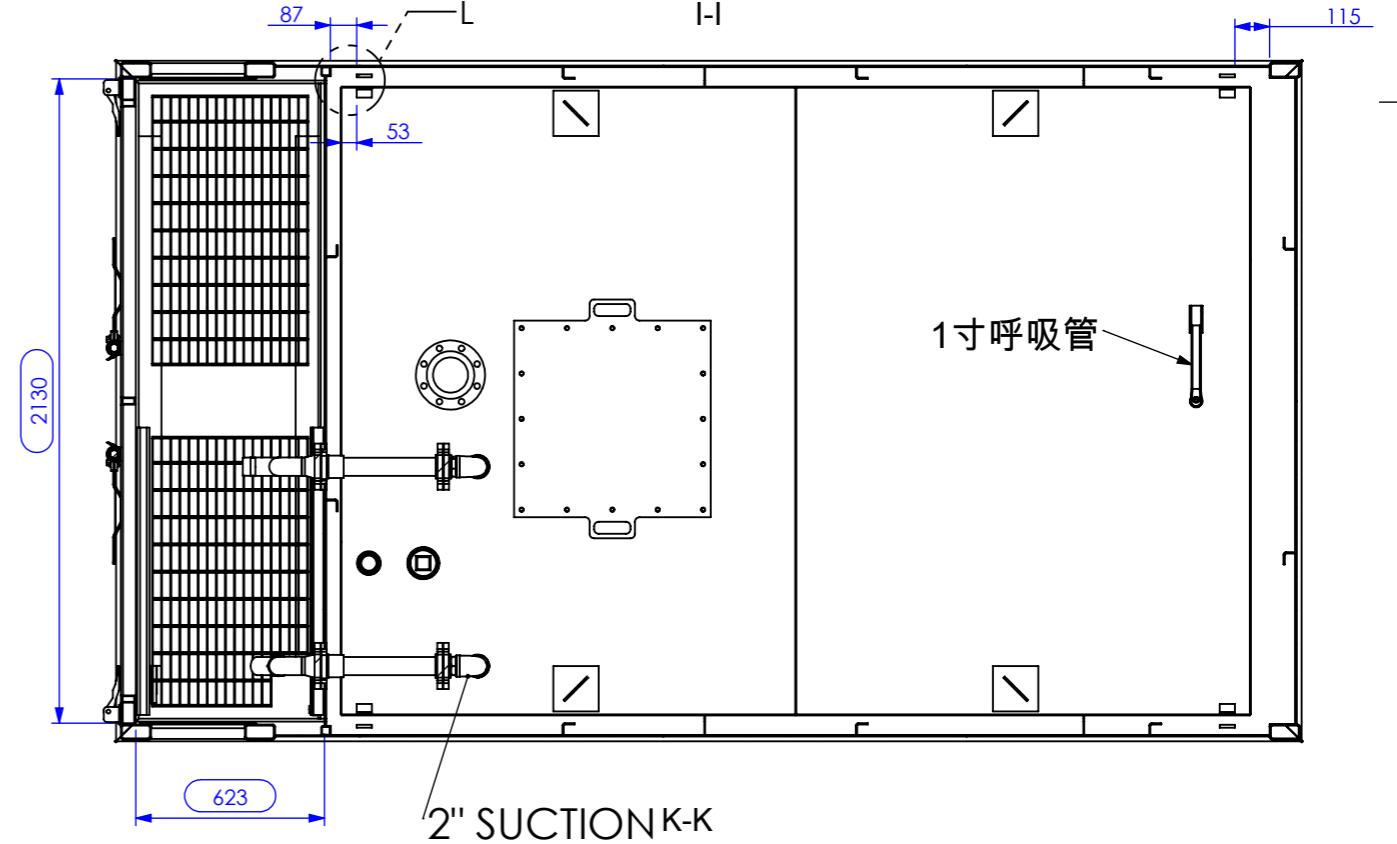
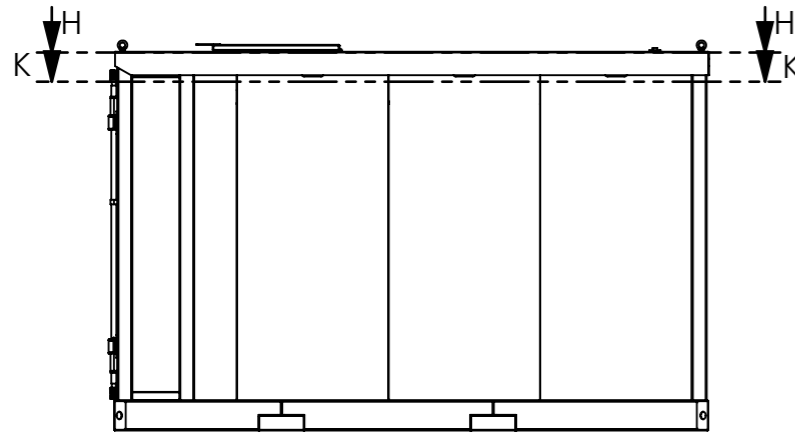

THIRD ANGLE PROJECTION

NAME	DATE
DRAWN	2015/6/19
CHK'D	
APPV'D	

TOLERANCE U.N.O.
 0 = -1.0
 0.0 = -0.4
 0.00 = -0.1

MATERIAL:
 WEIGHT: 3205 Kg

DWG NO. / PART NO. ADBLUE AB-11 11,000L	JOB NO.
LIQUIP:	
TITLE:	
SCALE: N.T.S.	SHEET 3 OF 3
SHEET SIZE A3	
REVISION	

DO NOT SCALE FROM DRAWING. IF IN DOUBT: ASK

UNLESS OTHERWISE SPECIFIED, ALL DIMENSIONS ARE IN MILLIMETRES

BEWARE OF 100mm MEASURING ERROR

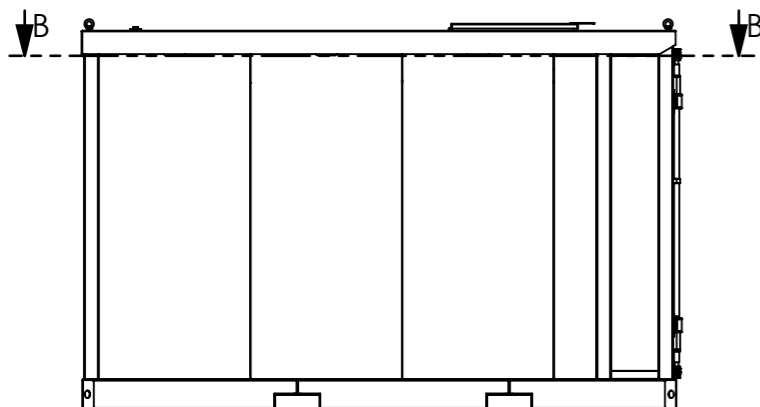
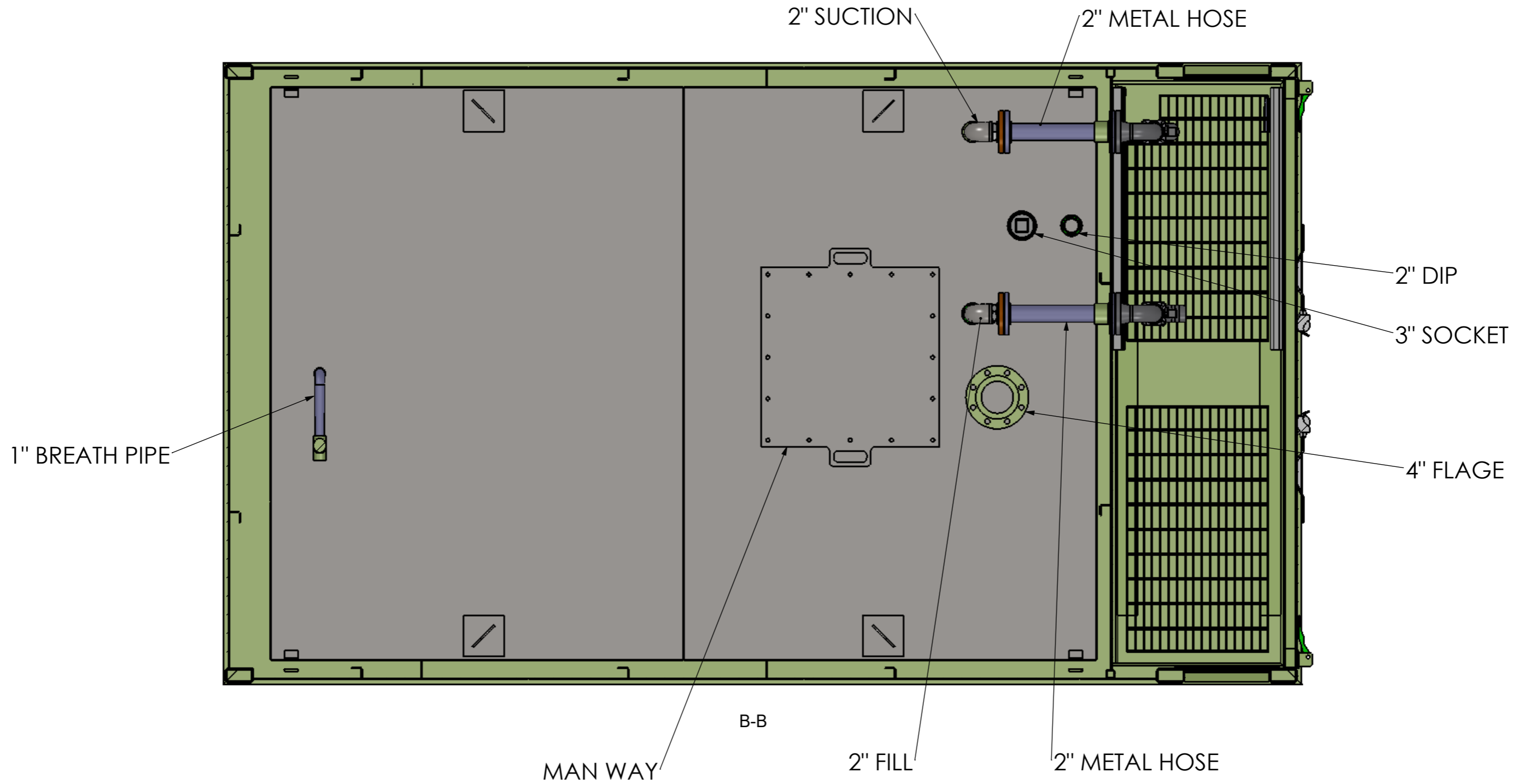

THIRD ANGLE PROJECTION

	NAME	DATE
DRAWN		2017/8/10
CHK'D		
APPV'D		



DWG NO. / PART NO. ADBLUE AB-11 11,000L		JOB NO.
CLIENT:		
TITLE:		SHEET SIZE A3
SCALE: N.T.S.		SHEET 1 OF 2
		REVISION

PERFORMANCE U.N.O.
0 = -1.0
0.0 = -0.4
0.00 = -0.1

WEIGHT: Kg

DO NOT SCALE FROM DRAWING. IF IN DOUBT: ASK

UNLESS OTHERWISE SPECIFIED, ALL DIMENSIONS ARE IN MILLIMETRES

BEWARE OF 100mm MEASURING ERROR

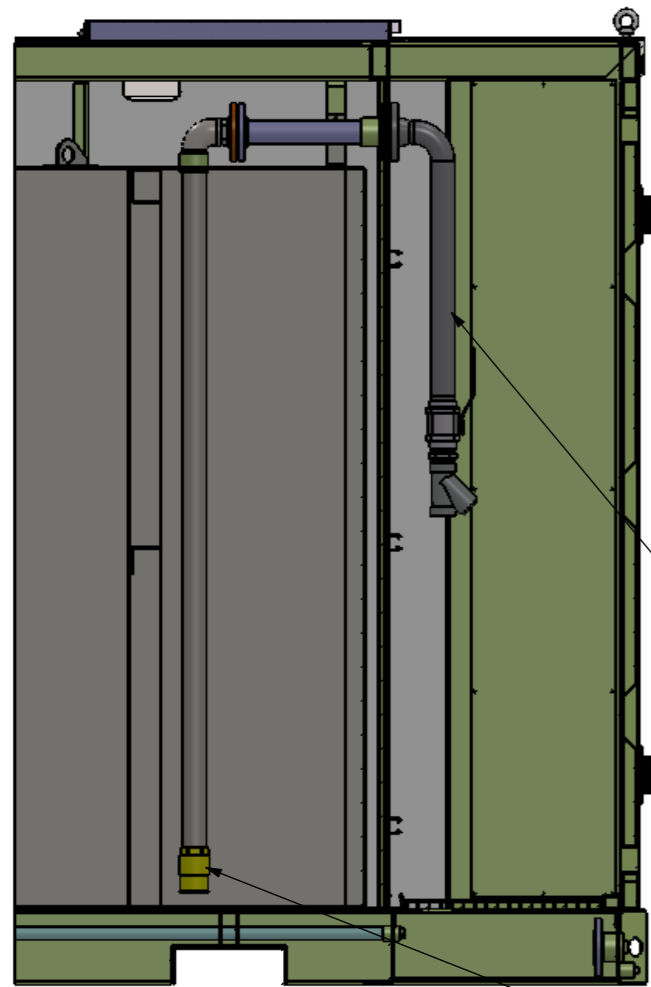

E-E

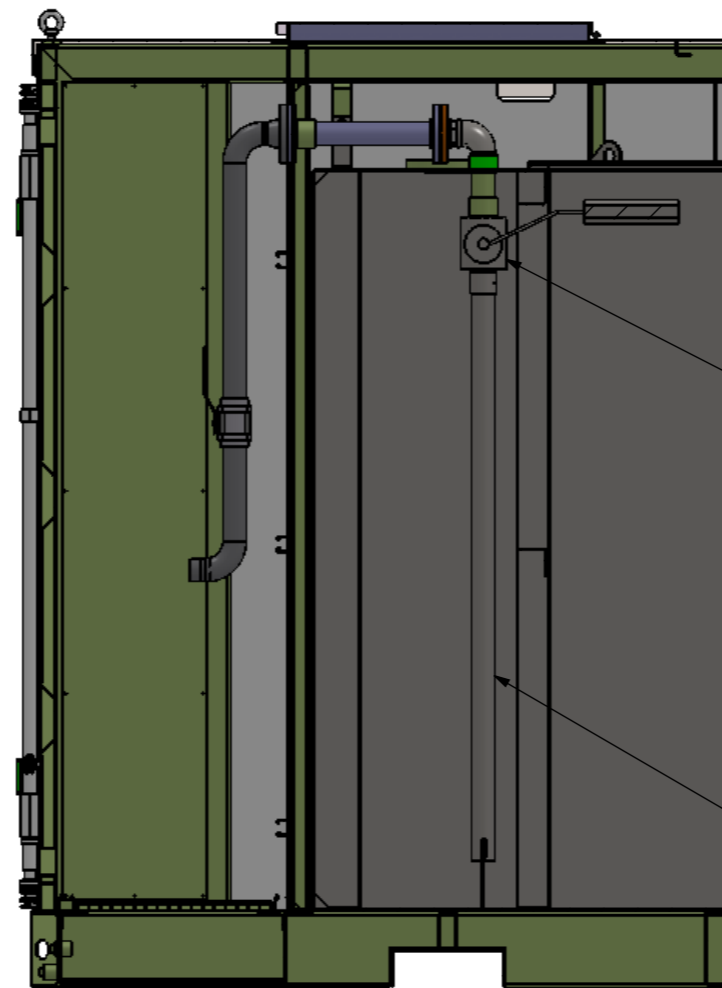

F-F

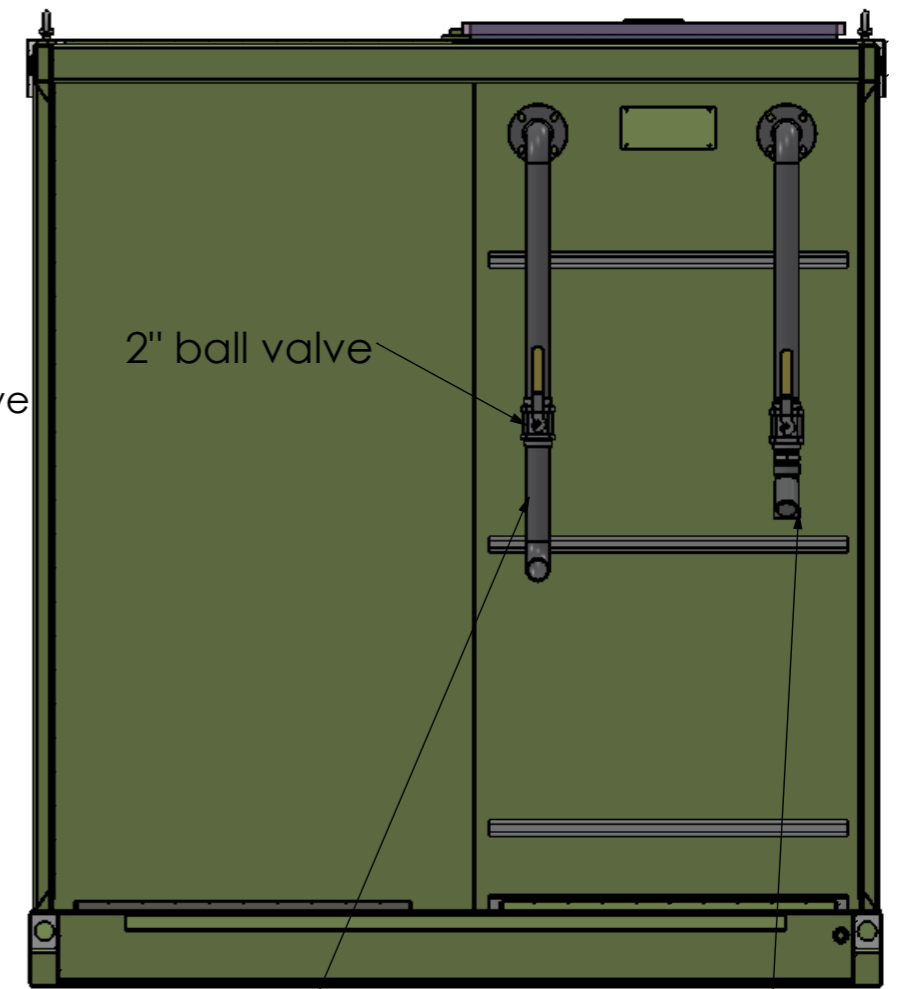

剖面 D-D

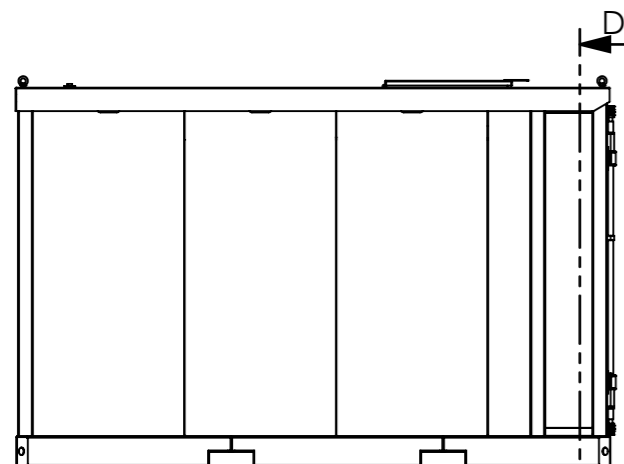
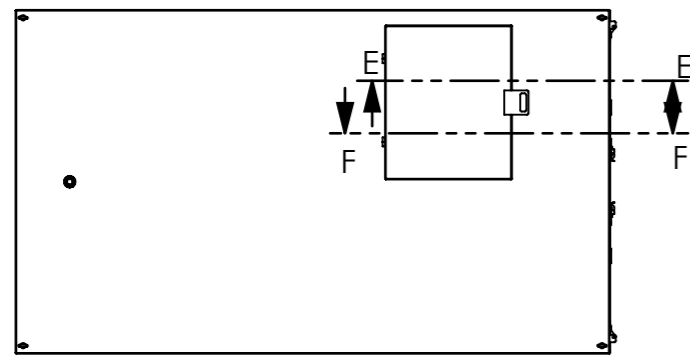

THIRD ANGLE PROJECTION	
NAME	DATE
DRAWN	2017/8/10
CHK'D	
APPV'D	



DWG NO. / PART NO.
ADBLUE AB-11 11,000L

JOB NO.

CLIENT:

TITLE:

SHEET SIZE
A3

REVISION

REFERENCE U.N.O.
0 = -1.0
0.0 = -0.4
0.00 = -0.1

WEIGHT: Kg

SCALE: N.T.S.

SHEET 2 OF 2