



## THE BEST BRANDS, THE BEST PRODUCTS

Your one stop shop for all sauna and steam needs.

---

2021

saunas.com  
(888) 503-8157  
info@saunas.com  
6700 N Linder # 152-180  
Meridian, Idaho 83646

## ●●● Dear Customer,

Congratulations on your purchase of the TheraSauna Classic, the new generation of Health Sauna. We are confident that you will enjoy many benefits of using your TheraSauna Classic for many years to come.

Carefully and thoroughly read this manual in its entirety before using your TheraSauna Classic for the first time. We recommend keeping this manual for regular review and future reference.

We attribute our growth and success entirely to our customer's satisfaction, the recognized health benefits, and the quality of our workmanship. We use only the best materials combined with state-of-the-art systems, construction and the highest safety standard in the industry.

You will be surprised at the noticeable effects on pain relief, weight control, detoxification, and stress reduction due to an increased blood circulation when using the TheraSauna Classic.

Whatever your needs, we invite you to experience the difference with the TheraSauna Classic: A difference in health benefits, a difference in quality, and a difference in our team of service and support personnel.

The whole TheraSauna team is looking forward to serving your needs.

# ●●● Table of Contents

●●● CONDITIONS OF USE.....	4
General Technical Characteristics.....	4
●●● PACKAGING AND INDIVIDUAL PANEL INFORMATION .....	4
Parts List .....	5
●●● INSTALLATION INFORMATION & ASSEMBLY .....	6
Assembly Instructions.....	7
(1) LOCATION OF SAUNA.....	7
(2) PLACING BOTTOM PANEL .....	7
(3) CONNECTING BACK PANEL TO BOTTOM PANEL.....	7
(4) CONNECTING SIDE PANELS .....	8
(5) INSTALLING BENCH HEATER PANEL .....	8
(6) PLUGGING BENCH HEATER CABLE .....	8
(7) INSTALLING BENCH PANEL .....	9
(8) INSTALLING WOODEN BACKREST .....	9
(9) CONNECTING FRONT PANEL .....	9
(10) PLACING TOP PANEL .....	10
(11) POWER SUPPLY CONNECTIONS.....	10
(12) CONNECT THE CONTROL WIRE OF THE CONTROL PANEL.....	11
(13) CONNECTING THE RADIO.....	11
(14) INSTALLING CUP HOLDER.....	12

<b>(15) DOORKNOB INSTALLATION .....</b>	<b>12</b>
<b>(16) Operating the LED Light .....</b>	<b>12</b>
<b>●●● DIGITAL CONTROL OPERATING INSTRUCTIONS .....</b>	<b>13</b>
<b>●●● SETTING UP THE CORNER MODEL .....</b>	<b>14</b>
<b>●●● TOP PANEL DIAGRAMS.....</b>	<b>16</b>
<b>●●● ENJOYING YOUR SAUNA.....</b>	<b>18</b>
<b>●●● MAINTENANCE .....</b>	<b>19</b>
<b>●●● WARNINGS .....</b>	<b>20</b>
<b>●●● LIMITED WARRANTY .....</b>	<b>21</b>

## ●●● Conditions of Use

1. Outside Ambient Air Conditions for Optimal Operation from +5°C ~+ 40°C (+41°F ~+104°F)
2. Relative humidity ≤ 85%
3. Depression: 700~1060 hpa
4. Main supply: 120V
5. Frequency: 60Hz±1

## General Technical Characteristics

1. Functions processed by microprocessors
2. Temperature adjustable from 37.78°C to 60°C (100°F-140°F)
3. Adjustable use time from 0 to 60 minutes
4. Digital temperature sensor
5. SoftTouch™ Control
6. Long-life ceramic TheraMitter™ heaters

## ●●● Packaging and Individual Panel Information

The 1-person sauna and 2-person sauna will be packed in 2 boxes:

**PLEASE FIND OUT THE SAME NUMBER OF THE CARTON BOX.**

**FOR EXAMPLE: "NO.001: 1 OF 2" FIT "NO.001: 2 OF 2" ON CARTON PACKAGE. THEN YOU CAN ASSEMBLE OUR SET VERY EASILY.**

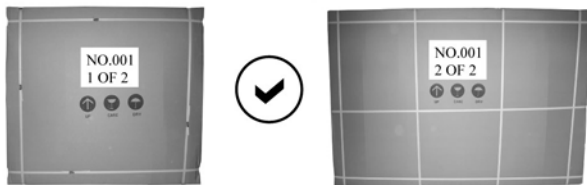

The 3-person corner saunas and above will be packed in 3 cartons

**PLEASE FIND OUT THE SAME NUMBER OF THE CARTON BOX.**

**FOR EXAMPLE: "NO.001: 1 OF 3" FIT "NO.001: 2 OF 3" FIT "NO.001 3 OF 3" ON CARTON PACKAGE. THEN YOU CAN ASSEMBLE OUR SET VERY EASILY.**



NOTE: PLEASE DO NOT MIX PACKAGE (MEANS PARTS FROM DIFFERENT BOXES CAN NOT BE INSTALLED TOGETHER, OR EXCHANGED).

## Parts List

Front Panel	Left Side Panel
Bottom Panel	Right Side Panel
Top Panel	Bench Panel
Back Panel	Bench Heater Panel
Accessory Box	

Below are pictures of individual panels for the 2-person model. Other models vary.

**Front Panel**



**Bottom Panel**



**Top Panel**

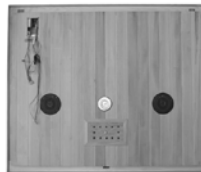

**Back Panel**



**Left Side Panel**



**Right Side Panel**



**Bench Panel**



**Bench Heater Panel**



**WARNING!!!** The receptacle provided by the manufacturer must be installed by a qualified electrician only.

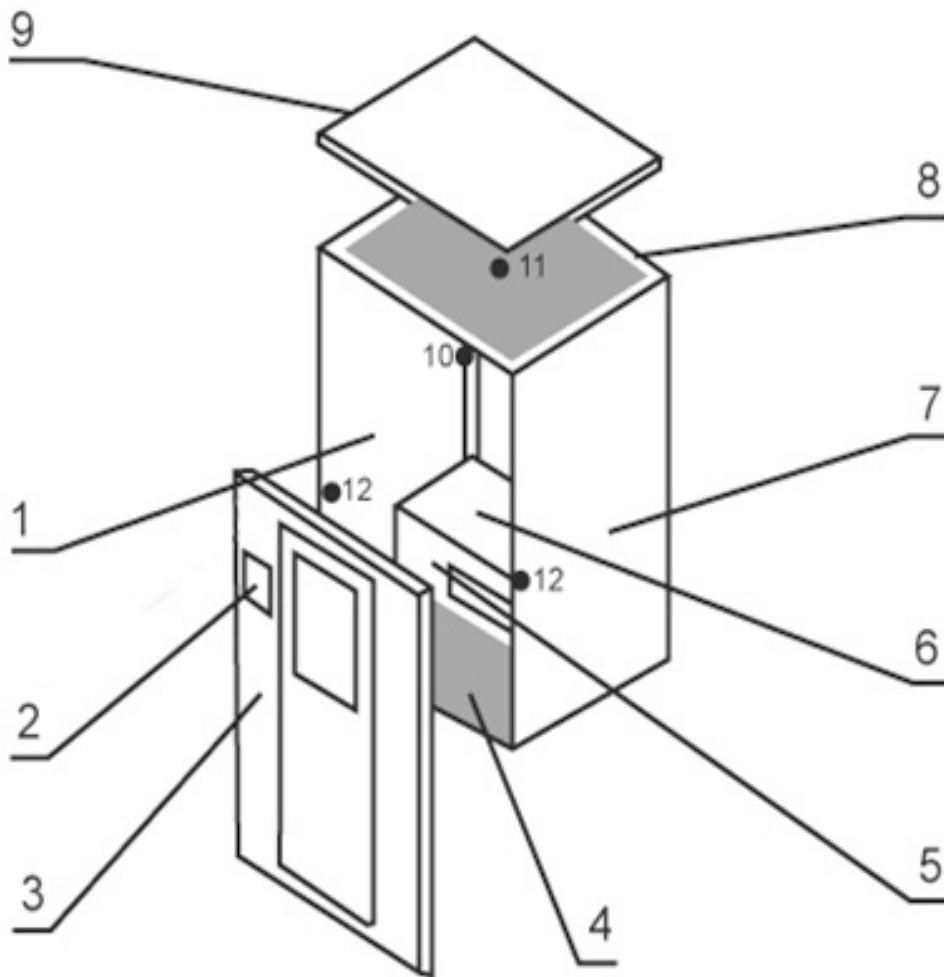

1. Left Side Panel	2. Digital control panel
3. Front Panel	4. Bottom Panel
5. Bench Heater Panel	6. Bench Panel
7. Right Side Panel	8. Back Panel
9. Top Panel	10. CD player
11. Light	12. Cup holder

## ●●● Installation Information & Assembly

- A. Do not plug any other appliances into the outlet with your sauna.
- B. The sauna should always be placed on a fairly leveled surface.
- C. The sauna must be placed indoors and in a dry area.
- D. Do not spray the exterior with water. If your floor is damp, install a floor separator to keep the sauna high & dry.
- E. Do not store flammable objects or chemical substances near the sauna.

## Assembly Instructions

Assembly of the sauna requires at least 2 adults to complete. Please read the instructions thoroughly before and during assembly to ensure proper installation of the unit. If you encounter any problems or have questions during assembly, please feel free to call our Customer Service Department or local dealers.

### (1) LOCATION OF SAUNA

When determining a location for your sauna, please keep in mind the following:

1. The Main Power Cord on the sauna must be easily accessible.
2. The location must be dry and level.

### (2) PLACING BOTTOM PANEL

Place the Bottom Panel on the ground and make sure that the "FRONT" sticker is facing the direction where the front of the sauna would be.



FRONT

### (3) CONNECTING BACK PANEL TO BOTTOM PANEL

Connect the Back Panel to the Bottom Panel by lining up the Back Panel on the groove of the Bottom Panel.



Buckle Open



Buckle Fastened



#### **(4) CONNECTING SIDE PANELS**

Connect the Side Panels to the Bottom Panels by lining up buckles and fastening them.

1. Each Side Panel has a white label to identify which side it is. The panel with "LEFT PANEL" label should be placed on the left side when facing the sauna from the front.



#### **(5) INSTALLING BENCH HEATER PANEL**

Slide down the Bench Heater Panel by lining up its sides with the Vertical Guides on each Side Panel.

1. Bench Heater Panel must be positioned so that the "TOP" sticker is facing up and the heater facing outward.
2. Be careful not to scratch the Side Panels when positioning the Heater Panel.



#### **(6) PLUGGING BENCH HEATER CABLE**

Plug in the Bench Heater Cable to the Outlet located on the Back Panel.

Make sure connection is secure.



## **(7) INSTALLING BENCH PANEL**

Install the Bench Panel by sliding it over the Horizontal Guides on each Side Panel. Be careful not to scratch the Side Panels when doing so.

Make sure to position the Bench so that the "BACK" sticker is facing back, the smooth and finished sides of the Bench are facing up and forward.



Back

## **(8) INSTALLING WOODEN BACKREST**

Screwing the screws of the web backrest to the back panel.



## **(9) CONNECTING FRONT PANEL**

Place the Front Panel onto the recessed area where the "FRONT" sticker is. Align buckles with both Side Panels and secure in place by fastening the buckles.



## (10) PLACING TOP PANEL

1. Open Sliding Doors located on the Top Panel.
2. Put the Top Panel on the assembled panels.
3. The Top Panel must be positioned so that the Cables on the Top Panel are in the front-left corner, right above the stereo.
4. Place the heater wires on the top of the back panel & front panel through the holes on the Top Panel
5. Gently place the Top Panel onto the rest of the assembled panels. When all four corners are in place, gently push down the Top Panel until it is snugly fit over the rest of the panels.
6. Make sure that the cables around the corners do not get pinched between the panels.



## (11) POWER SUPPLY CONNECTIONS

The power supply connector is like this:



1. Open the Sliding Door located on the top panel and connect plugs from heaters to control pack.
2. Please connect the power supply cord to heating units as follow pictures:



## (12) CONNECT THE CONTROL WIRE OF THE CONTROL PANEL

Plug in roof to power pack:

- Plug in the 4 back wall heaters to the control pack
- Plug in the front wall heater to the control pack
- Insert the Therma Couple through the holes in the blocks, shown circled in red

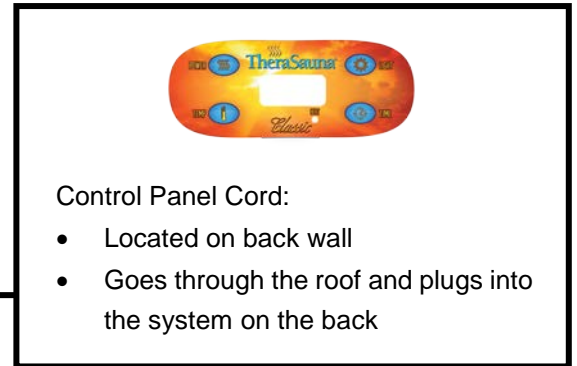
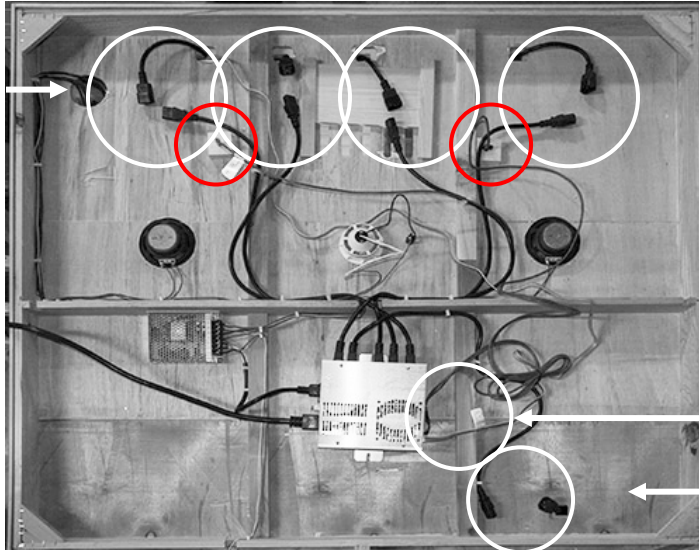

## (13) CONNECTING THE RADIO

Installing the radio:

1. First, plug the Connector pin to the socket on the back of the radio (You can pull out by pressing the top of the connector pin) and then the plug of the antenna.
2. Screw down the cover of the radio box.

Use the following pictures as reference to install your radio:



1

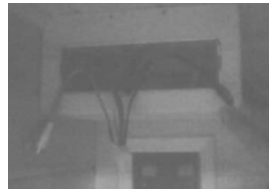

2



3



4



5



6



7



8

Operation of the Radio- See stereo owner's manual packed separately with the stereo.

**Note:** The light button must be on to operate the stereo.

## (14) INSTALLING CUP HOLDER



Attach cup holders in the fore left corner and the fore right corner (when sitting in the sauna).

## (15) DOORKNOB INSTALLATION

1. Align the Outside Doorknob against 2 holes on the outside of the door, hold it at an angle against the door.
2. Insert the Screw into the hole located on the inside of the door. Screw until it is tightly fit.



## (16) Operating the LED Light

1. To turn on the light, press the “light” button on the sauna control panel. The light will default to the chromo therapy color cycle.
2. To control the light, use the included remote to choose the color of the light, and the mode. There are four modes: flash, strobe, fade, and smooth. You may also adjust the brightness with the remote.
3. To turn off the light, use either the remote “Off” button, or press the light button on the control panel.  
Note: Pressing the light button on the control panel will also turn off the exterior lights.



# ●●● Digital Control Operating Instructions

## Digital Keypad Start Up & Adjustments



**Note:** If you experience power failure, sauna will return to factory default settings, which are 135°F and 60 minutes, you will have to reset your settings. On powering up the sauna, the panel will display sauna internal temperature.

Once the TheraSauna® Classic reaches the set temperature, the heat indicator light will turn off to let you know the sauna has reached your desired temperature. This does not mean that the sauna is no longer emitting infrared, but that our patented, StableHeat™ system will now kick in. The onboard computer will reduce the voltage going to the TheraMitters™ to keep them on and emitting infrared, while simultaneously keeping the pre-set temperature from extreme fluctuations.

### Session Timer Adjustment

With sauna in the “Off Mode” (orange heater light off) repeatedly press time button until desired session time is reached.

### Setting Temperature

With sauna in the “On Mode” (orange heater light on) repeatedly press temperature up/down button until desired temperature is reached.

- When heater/light on/off button is pressed, the interior and exterior sauna lights will turn on. The sauna light may be turned on or off at any time in any mode by pressing light on/off button.
- Normal operating temperature is 100°F - 140°F (37.8°C - 140°C).

### Diagnostic Codes

SN: Bad temperature sensor, replace temperature sensors.

OH: Overheat, allow sauna to cool down. No service is needed.

## ●●● Setting Up the Corner Model

1. Place the bottom panel on the ground.



2. Connect the left back panel to the bottom panel by lining up the back panel on the groove of the bottom panel. Align buckles on both panels and fasten them, if applicable.



3. Connect two back panels by lining up buckles and fasten them securely in place.



4. Connect the side panels (Left & Right) to the back panel using sliding hinges. Each side panel has a white label to identify which side it is. The panel with "LEFT" label should be placed on the left side when facing the sauna from the front. The panel with "RIGHT" label should be placed on the right side when facing the sauna from the front.



5. Install the right heater bench first by sliding it over the horizontal bench guides. And then install the left heater bench. Continue to install right and left benches. Be careful not to scratch the adjacent panels when sliding in the bench. Push the benches all the way in until they touch the back panel and are securely in place.



6. Place the whole front panel onto the recessed area on the bottom panel. Align buckles both side panels and secure in place by fastening them.
7. Put the top panel onto the assembled panels.
  - a. The top panel must be positioned so that cables on the top panel are in the front left corner, right above the CD player.
  - b. Gently place the top panel onto the rest of the assembled panels. When all corners are in place, gently push down the top panel from the outside corners until it is snugly fit over the rest of the panels
  - c. Make sure that the cables in the front left corners do not get pinched between the panels.



## EXTERIOR LAMP SWITCH

To enjoy the deluxe exterior lights, turn on the switch located on the control panel, marked "Light."



# ●●● Top Panel Diagrams

The following pictures are the top panel of the sauna: The solid cycles are the nail holes on the top panel of the sauna, need knocking in nails (Size: 4-M4X30). NOTE: one person models do not have nail holes on the saunas

1 Person Model Top Panel:

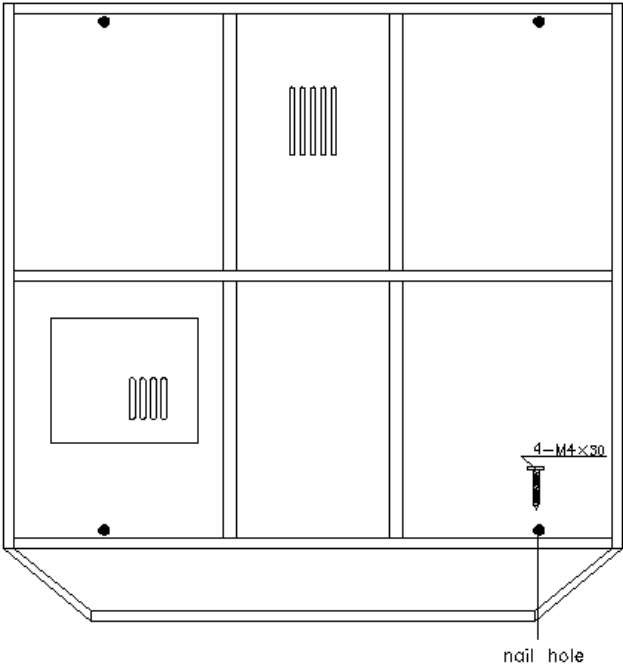

2 Person Model Top Panel:

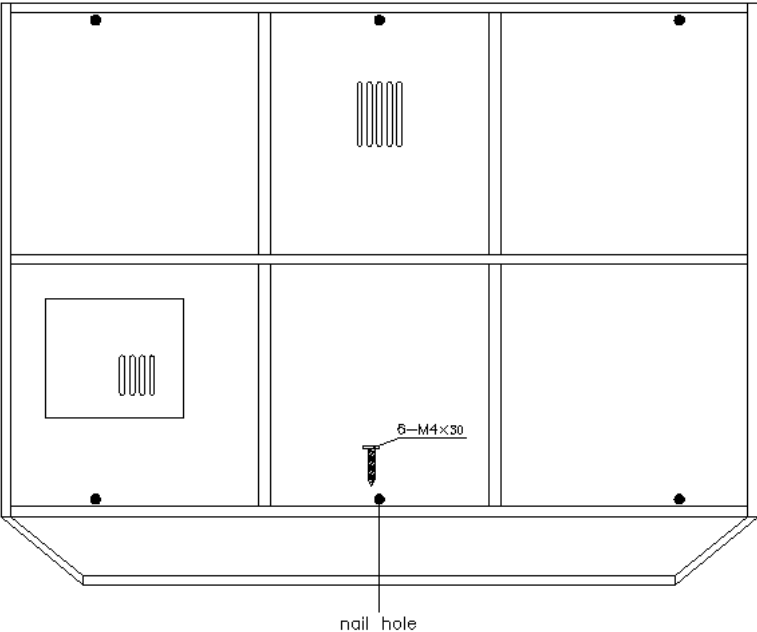

3 Person Corner Model Top Panel:

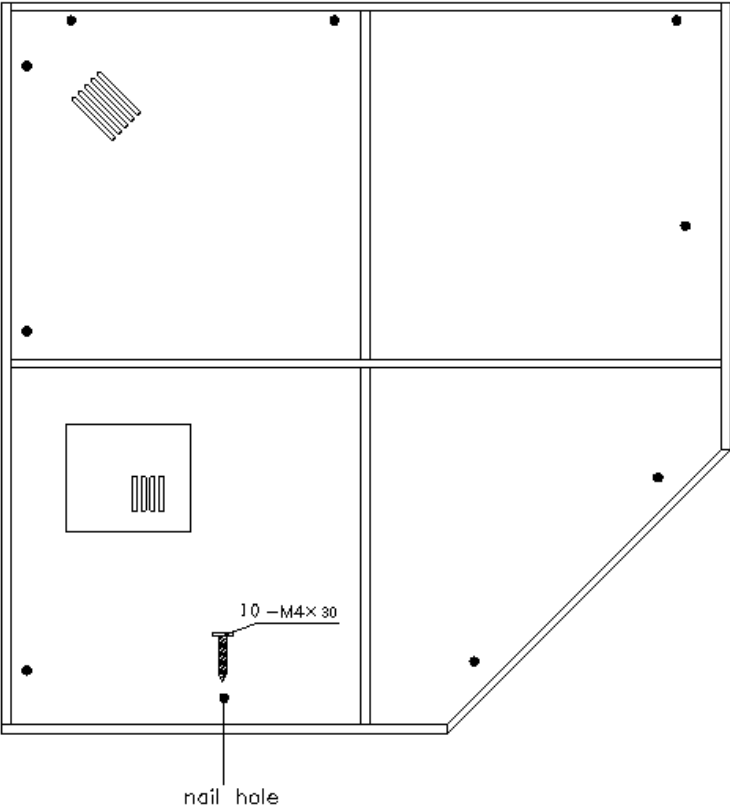

# ●●● Enjoying your Sauna

## INSTRUCTIONS FOR USE

Review all health and safety instructions. If in doubt as to the advisability of using your infrared sauna, consult with your physician. If you feel light-headed or heat-exhausted during a session, exit the sauna immediately.

1. Set the temperature to a comfortable level, normally, 37.8-60°C (100°F-140°F).
2. Allow approximately 15-20 minutes for the sauna to warm up before beginning a session.
3. Perspiration will begin within 10 to 15 minutes after stepping into the unit. We recommend that a sauna session does not exceed 30 minutes.
4. When the temperature reaches the setting level, the heaters will power down and trickle charge to maintain the desired temperature level inside of the sauna.
5. The front door/window and/or ceiling vent can be opened at any time to introduce fresh air into the sauna.
6. Infrared's unique property of direct penetration into the body without heating the intervening air in-between allows sauna users to enjoy all of its benefits while the door or window of a sauna is open for ventilation.
7. Please drink some water before, during, and after a sauna session. Doing so will replenish lost fluids from the body through perspiration.
8. Choosing to take a hot shower or bath prior to the sauna session will further promote perspiration. However, dry off thoroughly before going into the sauna because excessive water will stain or warp the wood. A shower after the session is refreshing and rinses perspiration from the body.
9. To absorb perspiration and keep the sauna tidy during the session, place a towel on the bench and floor of the sauna. Keep one towel handy to wipe excessive sweat from your body.

## Tips for Use

1. To regulate the temperature inside the sauna during your session, use the roof vent or the door window (by setting it at an angle).
2. If you feel the need for more cooling, simply leave the door open until the air around you feels comfortable enough.
3. Drink fluids prior to, during, and after your session.
4. If you take a hot/warm shower or bath before your sauna session, you may perspire more. Try it with and without bathing or showering first to determine which way you prefer.
5. To utilize the sauna's heat therapy effect, give your hair a hot oil treatment while in the sauna. Put oil or treatment into your hair and wrap it with towel. After the session is over, rinse your hair thoroughly.
6. Use at least 2-3 towels. Sit on one towel folded over several times for added cushioning. Put another towel on the floor to absorb extra sweat. A third towel draped over the knees may aid you in comfort and is useful to towel off sweat.

7. Be sure to towel off excess sweat during your session to help the body to perspire more freely.
8. To help relieve sore and tense muscles, massage the affected areas while in sauna to help heal faster.
9. Shaving your face or legs with a razor while profusely sweating in a sauna yields an incredibly smooth result without the use of gels or foams.
10. Do not eat anything at least an hour before your sauna session. It is better to go in the sauna on an empty stomach. You are more likely to feel uncomfortable sitting in a sauna with a full stomach.
11. To make the most out of your sauna session, work your muscles while in the sauna. Stretch your arms and legs, massage your neck, massage your feet, etc.
12. You can benefit from the relaxing and soothing effects of a regular sauna session by going to sleep afterwards. The peaceful and relaxed state rendered by a sauna session will help you sleep easier and better.
13. At the first sign of cold or flu, increasing your sauna sessions may be beneficial in boosting your immune system and decreasing the reproductive rate of the viruses.
14. Consult your physician for the proper treatment for this or any other conditions.
15. To treat your ankles and feet more effectively, you must elevate them while inside the sauna. Any area that you wish to achieve a specific deep heating effect in should be moved as close to one of the heaters as feels comfortable.
16. After the session is over, do not immediately jump into the shower. Since your body was heated up during the session, it will continue to sweat even after the heaters are off. Sit in the sauna with the door open and let the body sweat a little more while it cools off. After you feel comfortable enough, take a warm shower and finish it off with a cold shower to cool off completely.

## ●●● Maintenance

### Cleaning Your Sauna

- Clean the control faceplate with a damp towel, or clean with a small amount of hand-soap mixed with warm water if necessary. Clean the sauna room with a wet cotton towel, dry with a clean dry towel. Do not use benzene, alcohol, chlorine, or strong cleaning chemicals on sauna.
- Sanitize the sauna with a vinegar and water mixture and apply as needed. (5 parts water, 1 part vinegar)

**NOTE: Any chemicals that can damage the wood materials will damage the sauna and the protection layer that is on the wood.**

### Transportation and storage

1. Avoid exposure to rain, snow or strong collisions during transport.
2. Do not store in damp environments.

## ●●● Warnings

This appliance is not intended for use by persons (including children) with reduced physical, sensory or mental capabilities, or lack of experience and knowledge, unless they have been given supervision or instruction concerning use of the appliance by a person responsible for their safety. Children should be supervised to ensure that they do not play with the appliance!

### Safety Instructions

- Read and follow all instructions carefully.
- When installing and using this electrical equipment, basic safety precautions should always be followed.
- Do not use the sauna immediately following strenuous exercise. Wait at least 30 minutes to allow the body to cool down completely.
- Safety precautions:
  - To avoid fire, do not dry clothes or leave any towels in the sauna.
  - To prevent burns or electric shocks, do not touch or use metal tools on the aluminum cover of the far infrared heater elements. While in the sauna, do not touch the light bulb. If the bulb needs to be changed, switch it off and wait until the sauna is shut off and the bulb is cool
  - Do not spray water on the far-infrared ceramic heaters. This activity may result in electric shock or damage to the heater elements.
- Do not use the sauna if you have any of the following conditions:
  - Open wounds
  - Eye disease
  - Severe sunburn
  - Elderly people, especially those suffering from a disease, pregnant women and infants are prohibited. Children over the age of 6 years of age may use the sauna under the supervision of adults.
  - If suffering from a disease directly related to temperature, seek the advice of a doctor before use.
  - Persons suffering from obesity or with a medical history of heart disease, low or high blood pressure, circulatory system problems, or diabetes should consult a physician prior to using the sauna.
  - Persons using medications should consult a physician before using the sauna since some medications may induce drowsiness while others may affect heart rate, blood pressure, and circulation.
  - Do not place pets in the sauna.
  - Do not use the sauna if you are under the effects of alcohol. The use of alcohol, drugs, or medications prior to or during the sauna session may lead to unconsciousness.

## ●●● Limited Warranty

(See Warranty Guide for Complete Details)

We warrant the sauna to be free of defects in material and workmanship.

1. Heaters: Lifetime Warranty with a \$50 handling fee per incident
2. Workmanship: 12 months
3. Control: 36 months
4. Radio: 90 days
5. Labor & Electrical Components: 12 months

This warranty extends only to the original retail purchaser of the sauna and terminates upon transfer of ownership. Freight charges to and from the customer are the responsibility of the customer. This includes freight charges for parts shipped to enable the services of your sauna.

This warranty is void if the sauna has been used for commercial applications, and/or if the sauna has been altered, misused, or abused. Such instances shall include operation or maintenance of the sauna in deviation to the published instructions. The warranty extends only to the manufacturing defects and does not cover any damages resulting from mishandling of the product by the owner.

We shall not be liable for the loss of use of the sauna or other incidental or consequential damages. Under no circumstances shall we or any of our representatives be held liable for injury to any persons or damages to any properties. Some states do not allow exclusion or limitation of incidental or consequential damages, so the above limitations or exclusions may not apply to you. This warranty gives you specific legal rights, and you may also have other rights that vary from state to state. Specifications are subject to change without notice.

For your record, please complete the following information. You will need to refer to this information when contacting the manufacturer for customer service.	
<b>Date of Purchase</b>	
<b>Date of Delivery</b>	
<b>Model Number</b>	
<b>Serial Number</b>	
<b>Dealer Information (Name &amp; Phone)</b>	

 **WARNING**

**REDUCE THE RISK OF FIRES**

Do Not Install Closer Than 102mm or 4 inches  
To A Vertical Surface

 **WARNING**

**REDUCE THE RISK OF ELECTROCUTION**

Disconnect All Supply Connections Before Servicing  
This Appliance Has 1 Supply Connection

 **WARNING**

**REDUCE THE RISK OF ELECTRIC SHOCK**

Do Not Operate Unless Guard Is In Place

# **CAUTION**

## **REDUCE THE RISK OF FIRE**

Do Not Place Combustible Material On Heater At Any Time

# **WARNING**

## **REDUCE THE RISK OF OVERHEATING**

1. Exit immediately if uncomfortable, dizzy, or sleepy. Staying too long in a heated area is capable of causing overheating.
2. Supervise children at all times.
3. Check with a doctor before use if pregnant, in poor health, or under medical care.





This file was downloaded from the site  
[mans.io](http://mans.io)

## **Instruction manuals and user guides**

[Samsung](#)

[Pioneer](#)

[Alpine](#)

[LG](#)

[Dell](#)

[Sharp](#)

[Sony](#)

[Philips](#)

[Epson](#)

[Netgear](#)