



The best brands, the best products.

Your one stop shop for all sauna and steam needs.

Our Contact Information



1-888-503-8157



info@saunas.com

By providing superior service, providing a vast array of high-quality products, Saunas.com is the Internet's premier supplier of saunas, steam equipment, and accessories. We strive to make your visit at our website a fun and educational experience as well as a smooth purchase should you decide to honor us by buying a product. We hope you find a sauna to your liking, and many years of satisfying saunas in the future!

Please don't hesitate to call or email us with any questions you may have!

INSTALLATION GUIDE

ULTRA-SAUNA HEATER

Proudly made in USA since 1964

SMALL HEATERS 3.0-4.5 KW

Installation Instructions & User Manual



TABLE OF CONTENTS

1. Disclaimer	3
2. Important! Read Before You Start	4
3. Before You Start.....	5
4. Your Heater Should Include.....	6
5. Heater Sizing	6
6. Sauna Room Venting Guidelines.....	6
7. Recommended Sauna Room Ventilation	7
8. Sauna Heater Guard Rail Placement Guide.....	7
9. SCANDIA ULTRA-SAUNA HEATER GUARD RAIL	8
10. Control Panel Models And Sizes	9
11. Control Panel Location	9
12. Standard Heater / Control Configuration	10
13. Wiring Diagrams	12
14. Sauna Heater Operating Instructions	13
15. 24 hour timer Programming Instructions	14
16. Sauna maintenance	15
17. heater care	15
18. Ultra Sauna - Warranty	16
19. Technical Service Ticket	17

Congratulations on your purchase of your Scandia Ultra-Sauna electric heater!

Since 1964 Scandia Manufacturing has been making the best sauna heaters in the industry. Each heater is hand crafted and individually made by an expert technician. They are not mass-produced; we consider each heater a work of art.

To ensure your satisfaction with our heater we suggest you read through this guide and familiarize yourself with:

1. Installation Instructions
2. Electric Heater Component List
3. Warranty Information
4. Troubleshooting Guide

Safety First

You must consult a licenced electrician to assist you with installation and connection of your Scandia Ultra-Sauna. Self-installations will void your warranty.

When you receive your heater you should inspect it within 48 hours to verify all parts, materials and instructions are there. Scandia is not responsible for replacing or warranting items that are not reported within 5 days of receipt of your shipment.

If your shipment is damaged please retain all packaging and call us immediately

Prior to installation, the installer (licenced professional) should check all connections and parts to ensure proper fitting. These items may have come loose in shipping. You can rest assured knowing that your unit was tested in our production facility prior to shipping to ensure proper working order. Loose connections and/or improper installation are the most common reasons for your unit not heating up right away. Do not call the manufacturer until a licensed professional has checked to ensure proper connection.

The heater must be installed with a heater guard rail – see instruction for proper clearances.

Caution signs are included for your safety.

Maximum recommended ceiling height is 7 feet.



IMPORTANT! READ BEFORE YOU START

- Heater and controls must be installed by a licensed electrician.
- Heater must be installed according to local codes.
- Heater controls must never be installed inside the sauna room.
- Heater controls should never be placed near water.
- Scandia heaters are wall-mount heaters and must be installed accordingly.
- Ensure that thermostat sensor is properly installed inside the room (except for T-model heaters).
- Ensure all factory connections are tight as wires may have come loose in shipping. Torque to proper specifications.
- Heater should not be operated without recommended amount of rocks. Use only Scandia's supplied rocks.
- The warning signs and sauna usage plaque must be displayed.
- Sauna room must be vented according to manufacturer's specifications or Scandia's Installation Instructions.
- Plastic must be removed from heater body before operating heater.
- Heater should not operate without specified heater guard.

GENERAL SAUNA ROOM GUIDELINES

Sauna room must be properly constructed and well insulated according to sauna kit installation guidelines, including the following recommendations:

- Sauna room interior should be finished entirely with kiln-dry, softwoods such as Clear Western Red Cedar.
- Sauna room walls should not include the following finishes: ceramic tile, rock or any material that will retain heat in the walls as this can cause the heater to overheat.
- Sauna room must be properly vented.
- Sauna door must always open outward.
- Sauna door can never include a lock.
- Heater must have a heater guard made according to Scandia's specifications. Never put heater in a cove where airflow is restricted.
- Industry standard—Recommended sauna ceiling height is 7ft (84"). Sauna rooms with ceiling height exceeding 8ft (96") will result in automatic void in heater warranty.

GENERAL USAGE, CARE AND MAINTENANCE

- Do not touch heater while in operation.
- Do not cover heater.
- Do not hose down the sauna room or heater.
- Check and clean rock tray monthly or as needed.
- Refer to our complete usage, care and maintenance guidelines available on Scandia's website.

TROUBLESHOOTING GUIDELINES

Troubleshooting guidelines are available on Scandia's website. If you need additional assistance, please consult your certified professional first, then submit a technical ticket via website if further assistance is needed www.scandiamfg.com/contact.

BEFORE YOU START

- Heater and controls must be installed by a licensed electrician
- Heater must be installed according to local codes.
- Ensure all factory connections are tight. Wires may have come loose in shipping.
- Plastic must be removed from shell before operating heater.
- Sauna door must always open outward.
- Sauna door can never include a lock.

YOUR HEATER SHOULD INCLUDE

- Controls
- Main Heater Unit
- Sauna Rocks
- Thermostat sensor wall cover (not included with T-model heaters)
- Installation Instructions
- Warning Sign
- Warranty information

HEATER SIZING

Ultra Sauna Heaters—Small (16" W x 10 3/4" D x 23-1/4" H)					
Model	Watts	Volts	Phase	Amps	Max Room Size
30240	3000	240	1	12.5	140 cu ft (3.96 cu m)
30208	3000	208	1	14.4	140 cu ft (3.96 cu m)
45240	4500	240	1	18.8	210 cu ft (5.95 cu m)
45208	4500	208	1	21.7	210 cu ft (5.95 cu m)

SAUNA ROOM VENTING GUIDELINES

Sauna room should be vented according to manufacturer's specifications or Scandia sauna room specification found in the Scandia sauna installation instructions. Improper ventilation is dangerous for the sauna user's health. When the door is under cut, there is no other venting required in small sauna rooms. You should have between 3/4" to 1" between the finished floor and the bottom of the door. If further venting is preferred or required, the inlet vent should be below the heater, or near the base of the heater. Outlet vent can be on the opposite wall of the heater under the top bench.

RECOMMENDED SAUNA ROOM VENTILATION

Proper venting and positioning of sauna vents is going to result in a more comfortable sauna experience. Ideally, intake and exhaust vents are placed in opposite positions in the sauna room.

The intake vent in the wall should be located immediately behind the heater as low as possible to the floor. Whenever the heater is on, some outside fresh air will be pulled into the low pressure area under the heat. As the hot air rises through the heater, new air must move to replace it under the heater.

The exhaust vent inside the sauna should be placed as far away from the intake vent as possible (ideal location would be on the wall between the upper and lower bench).

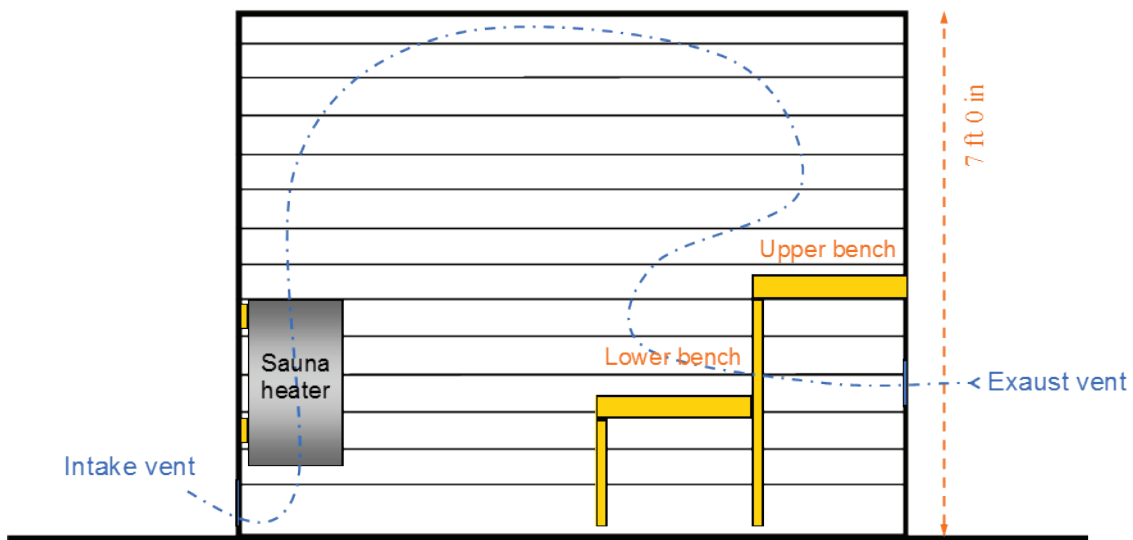

The vents should be adjustable with louvers.

The sizes of vent may vary, typical standard size that is found in most hardware stores is 4"x10" floor

SAUNA HEATER GUARD RAIL PLACEMENT GUIDE

Minimum dimensions of heater guard must be 26" L x 16" d x 29-1/4" H - Top rail of guard must be below heater vent

SCANDIA ULTRA-SAUNA HEATER GUARD RAIL

	CHASSIS	SMALL
	Description	3KW-4.5KW
A	Width Of Heater Shell	16"
B	Wall to Face of Heater	10 3/4"
C	Side of Heater to Wall (Min.)	5"
D	Height of Heater Shell	23 1/4"
E	Wall to Inside of Guard (Min.)	16"
	Lower to Upper Mounting	21"
	Floor to Bottom Mount	11"
	Heater Center to Wall (Min.)	13"
	Floor to Bottom of Heater	10"
	Top of Heater to Ceiling (7ft.)	45"

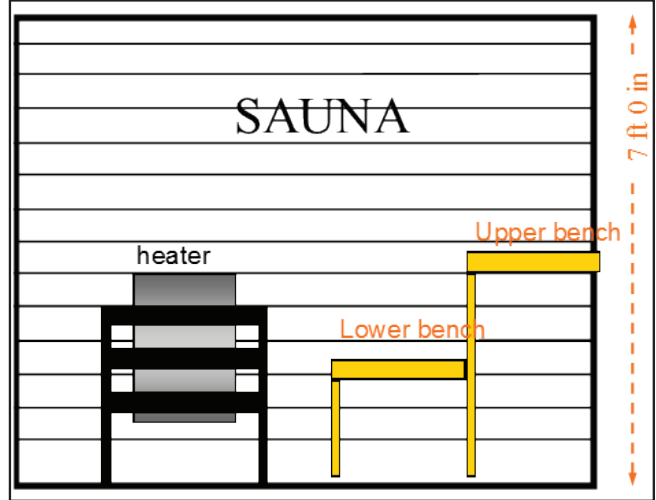

Back Wall

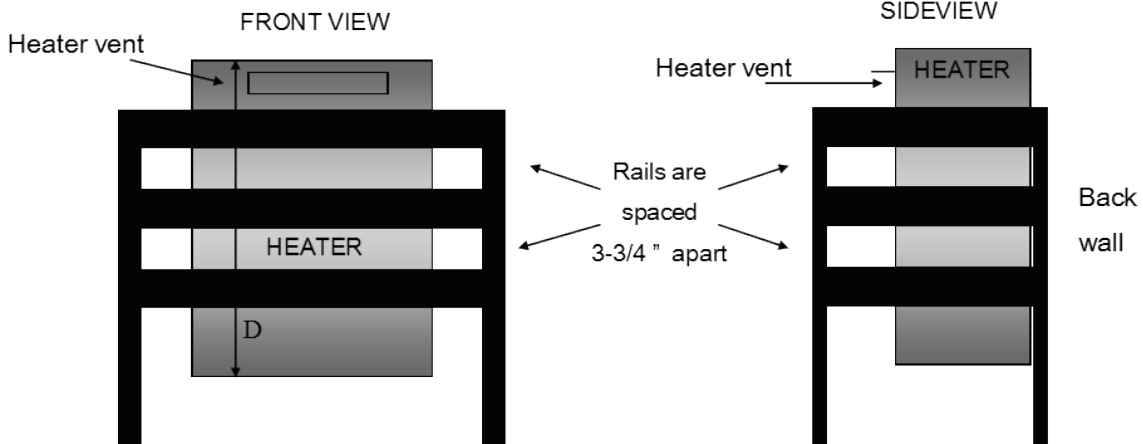
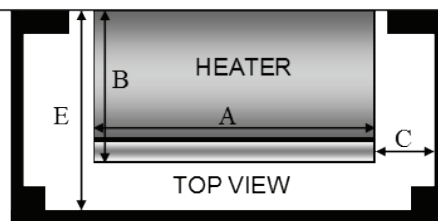

Components for 3-sided heater guard:

- 2x 2x2 corner posts / legs
- 3x 1x4 rails long piece rails for front
- 6x 1x4 short piece rails for each side
- 2x Wall brackets
- Misc. screws

**2-sided heater guard will have
1 post and one side only.**

Heater guard rail installation:

- All components come ready to be assembled
- Observe distances around heater for guard rail, walls, benches and other obstructions
- Follow the heater manufacturer's clearances recommendations.
- Do not cut down heater guard to fit!

CONTROL PANEL MODELS AND SIZES

CHASSIS		SMALL
Description		3KW-4.5KW
A	Width Of Heater Shell	16"
B	Wall to Face of Heater	10 3/4"
C	Side of Heater to Wall (Min.)	5"
D	Height of Heater Shell	23 1/4"
E	Wall to Inside of Guard (Min.)	16"
F	Lower to Upper Mounting	21"
G	F.F. to Bottom Mount	11"
H	Heater Center to Wall (Min.)	13"
I	F.F. to Bottom of Heater	10"
J	Top of Heater to Ceiling (7ft.)	45"

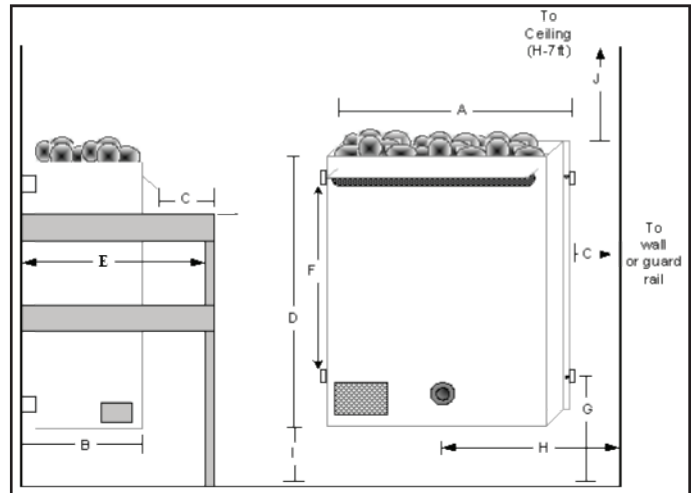

CONTROL PANEL LOCATION

All controls must be mounted on the outside of the sauna, NEVER inside the room.

H CONTROL: suitable for heater models 30240-T, 30208-T, 45240-T, 45208-T, 60240-T (T-model heaters only)

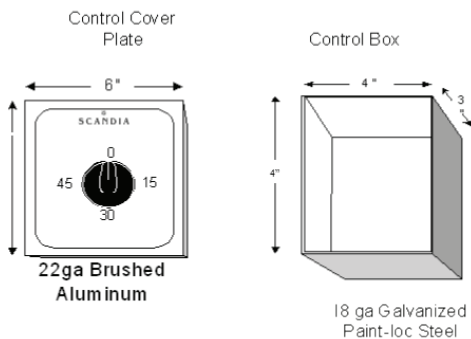

F CONTROL: suitable for heater models 30240, 30208, 45240, 45208, 60240

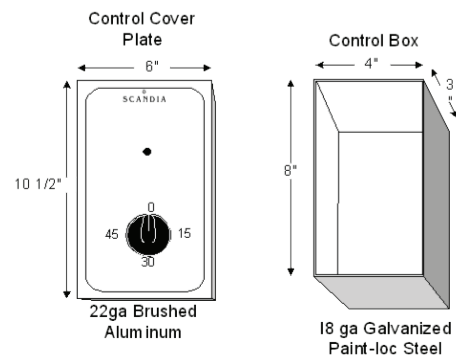

RESIDENTIAL INSTALLATION – For convenience, place the control box at eye level by the door, approximately 12" from the door opening and 42" from the floor (see fig. 1). For conduit and wire size, type and quantities, see specific heater wiring diagram charts.

COMMERCIAL INSTALLATION – for 60-min timer, follow the residential installation recommendations. For 24-hour timer, you may place the control panel either in front of the sauna or in the mechanical or electrical room away from the sauna room. Please note that the thermostat capillary tube is only 4 ft long, therefore for controls placed away from the sauna, we recommend T-model heaters, where the thermostat is built in the heater itself.

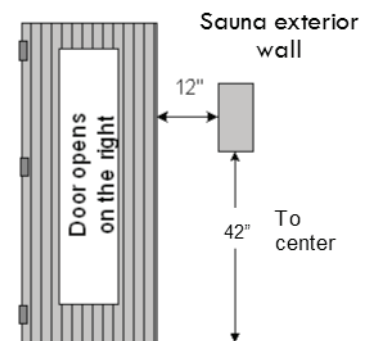

STANDARD HEATER / CONTROL CONFIGURATION

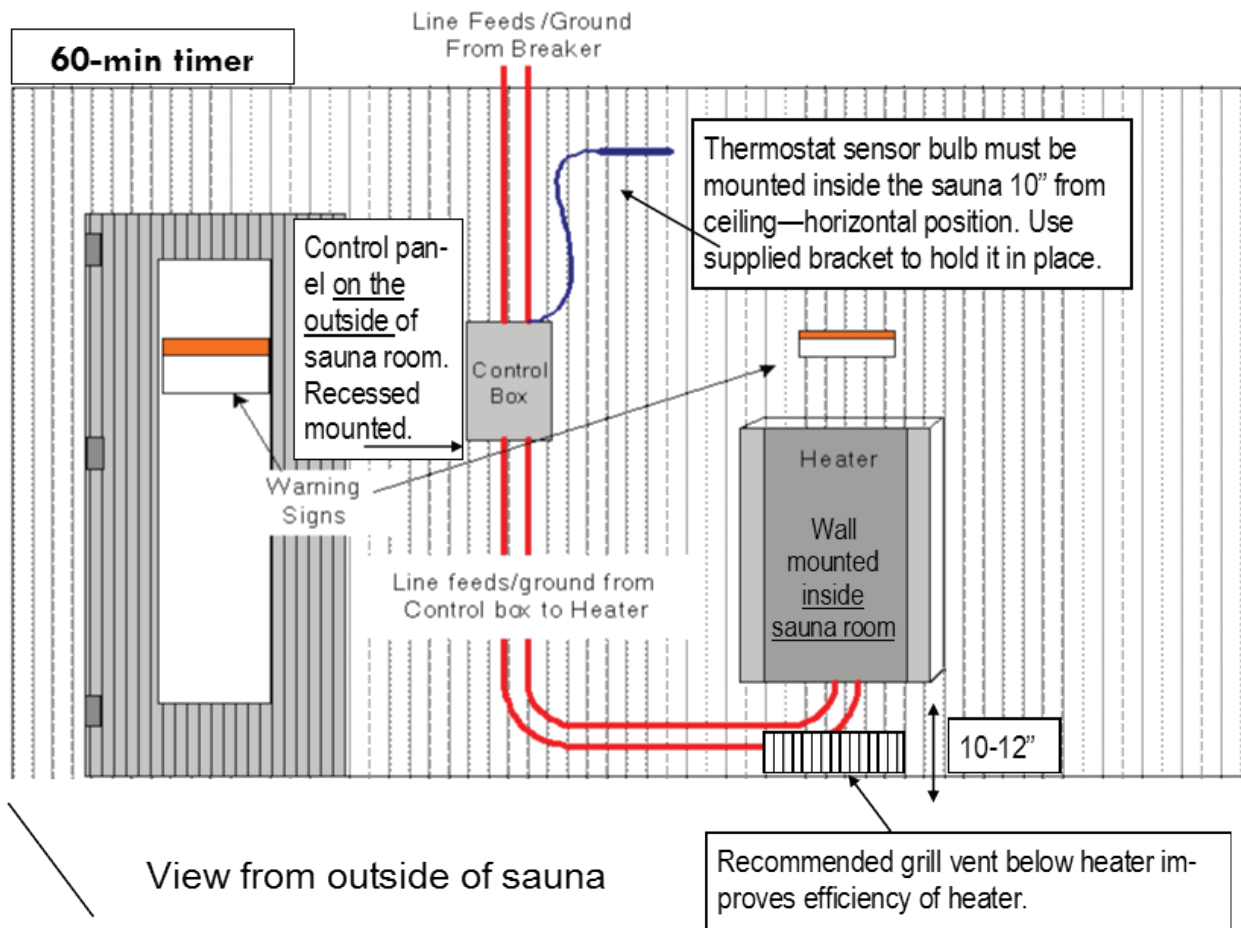

Note:

All Ultra-Sauna heaters can be ordered as T-model from factory. T-model heaters have the thermostat built into the heater, eliminating the need to have the thermostat sensor in the wall.

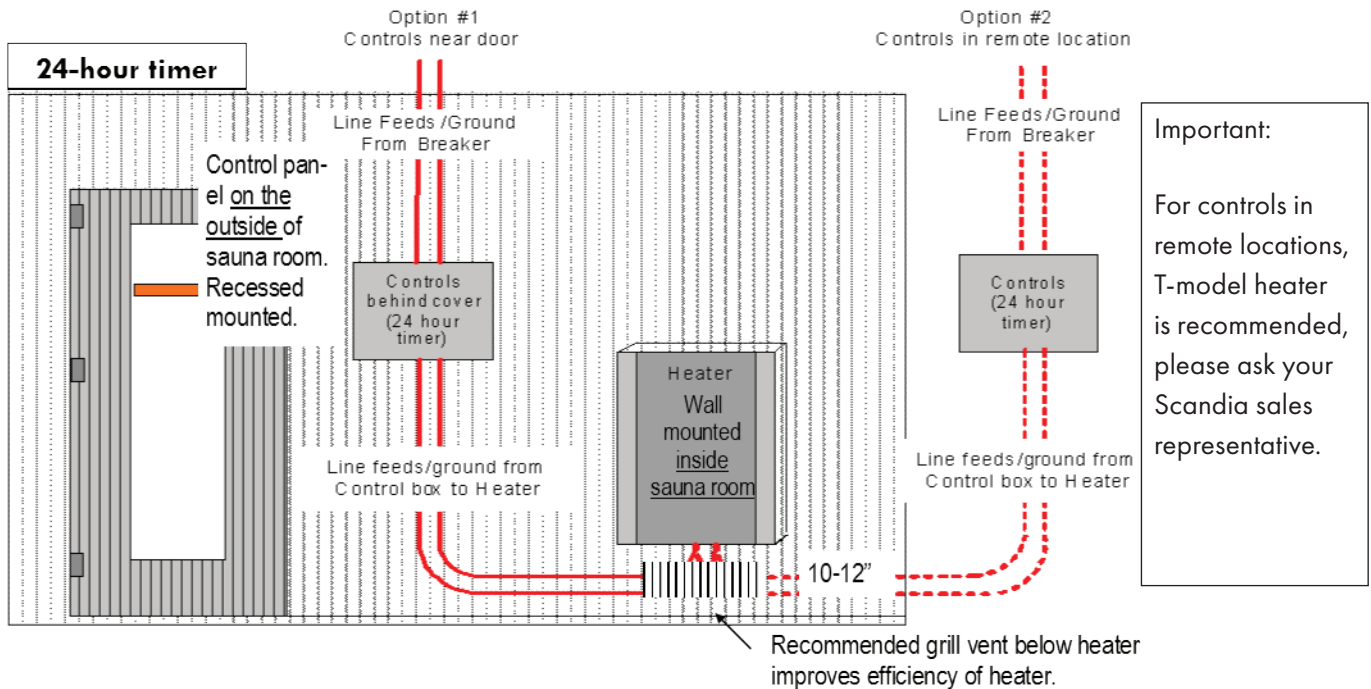

Important:
 For controls in remote locations, T-model heater is recommended, please ask your Scandia sales representative.

Important Notes

- Heater must be installed by a licensed electrician.
- Heater must be installed inside the sauna room and mounted 10-12 inches from the floor.
- Controls must be installed outside of the sauna room.
- Thermostat capillary sensor bulb must be located inside the sauna room (horizontal position) approx. 10 inches from the ceiling.
- All wiring must comply with Local and State ordinances: all wiring into the sauna room must be rated for at least 90 degrees Celsius (194 deg Fahrenheit)
- Standard sauna ceiling height is 7 feet.
- Consult all local codes before installation.
- Warning signs must be installed at eye level on door and above heater.
- Door must always swing outward.
- Air intake vent must be installed below heater and an air exhaust vent should be installed.
- Thermostat should be placed behind cover and out of control of guests / members. Setting should be no higher than 180 degrees fahrenheit (85 Celcius)

WIRING DIAGRAMS

SERIES	WATTS	VOLTS	AMPS	PHASE	MAX ROOM SIZE	CIRCUIT BREAKER	SUPPLY WIRES	WIRES FROM CONTROL TO HEATER
60	5000	240	25	1	294 CU FT	30	3 QTY #10	3 QTY #10

H CONTROLS

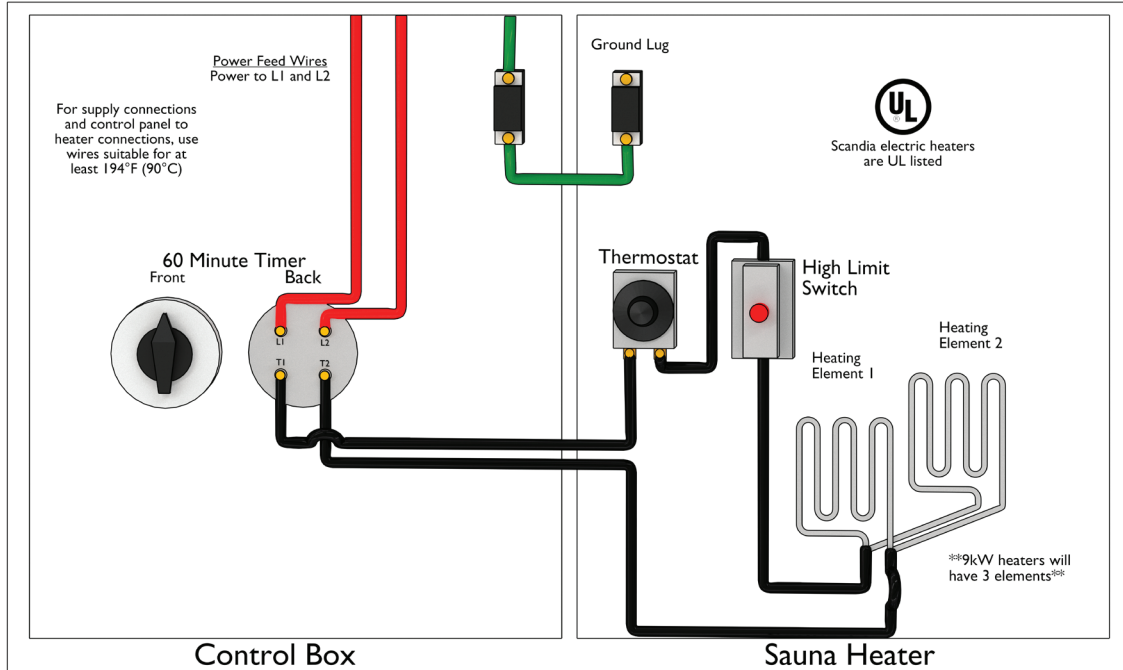

SERIES	WATTS	VOLTS	AMPS	PHASE	MAX ROOM SIZE	CIRCUIT BREAKER	SUPPLY WIRES	WIRES FROM CONTROL TO HEATER
60	5000	240	25	1	294 CU FT	30	3 QTY #10	3 QTY #10

F CONTROLS

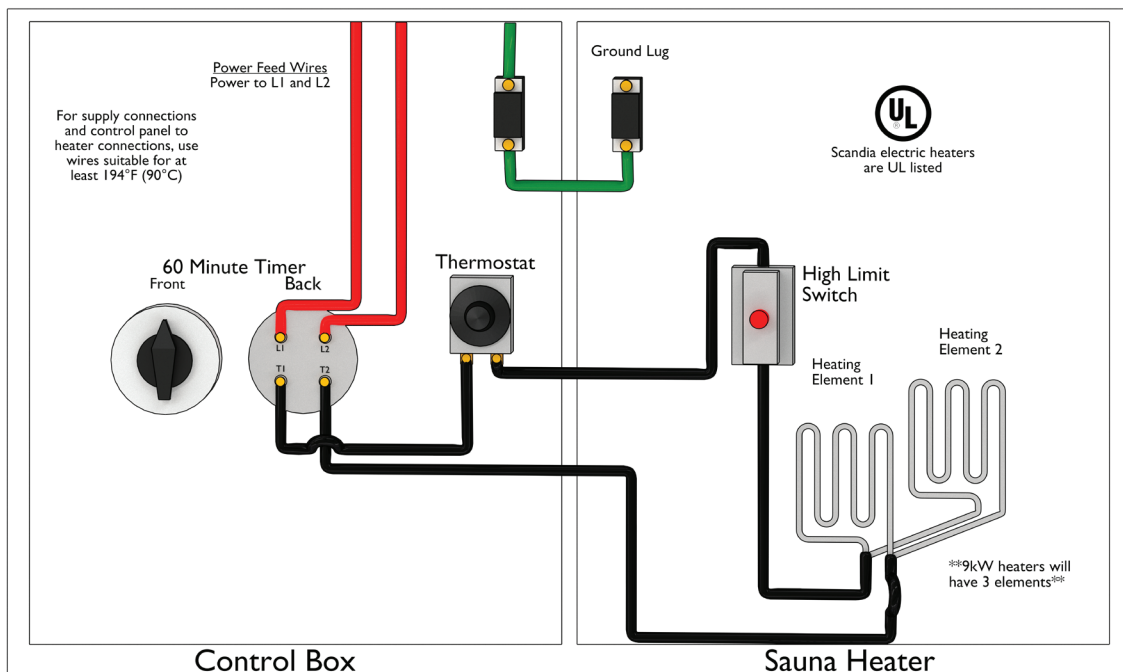

SAUNA HEATER OPERATING INSTRUCTIONS

Installation steps:

1. Remove the protective cover off the heater shell.
2. Hang the heater in place or as specified by manufacturer.
3. Fill the heater rock tray with the sauna rocks. Note: This sauna heater should not be operated without the recommended quantity of rocks.
4. ENSURE GOOD AIR CIRCULATION AROUND SENSOR BULB.

Install the heater guard rail around heater. After installation is completed, the heater should be turned on to maximum temperature for one hour to break any rocks with fault lines and to burn off the protective coating on the heater elements. Do not enter the sauna room during the initial start-up. The smell of smoke and cracking of rocks will not re-occur.

Sauna Timer:

Scandia' Sauna controls come with standard 60 minute timer (wall mounted outside the sauna) and thermostat . For T models, the thermostat is located on the heater. To turn on the heater, turn the timer knob up the desired time (up to the 60 min. mark). Leave knob at the setting and sauna will operate for one hour before shutting off automatically. Allow 30 minutes for room to heat up to an average sauna temperature. The thermostat is marked with numbers 1 through 10. With 1 being the coolest temperature and 10 the highest. Set the desired temperature. Note: Make sure the thermostat is on before setting up the time, otherwise the heater will not heat up."

For 24-hour timer operation, see attached Operating Guidelines for 24-hour digital timer.

Product Liability:

The buyer acknowledges that the goods sold to them by Scandia Manufacturing can cause property damage and personal injury if not properly sized, handled or installed. The buyer further agrees to indemnify and hold harmless Scandia Manufacturing from any or all claims for damage, loss and/or liability arising out of improper handling, sizing and/or installation of goods.

PROGRAMMING INSTRUCTIONS

24 digital hour timer

To Set or Change the Day and Time:

To clear entire memory, press the **RESET** key. Hold down the **CLOCK** key while pressing either the **DAY**, **HOUR** or **MINUTES** keys. Continue pressing until the desired day or number is shown. Then simply lift finger off of the **CLOCK** key to set.

To Set Program (ON/OFF times):

Press **TIMER** key once to enter into program mode. Display will show "1 ON - - - -"
Press **DAY** key to choose any of 15 different day combinations for the first **ON** time.
Note: days of the week with the same program should be copied by selecting the desired combination of days.

Press the **HOUR** key and then the **MINUTE** key to select the desired first **ON** time.

Press **TIMER** key once. Display will show "1 OFF - - - -". Repeat previous step to select the desired **OFF** time. Repeat the entire sequence to complete up to eight **ON/OFF** times as desired.

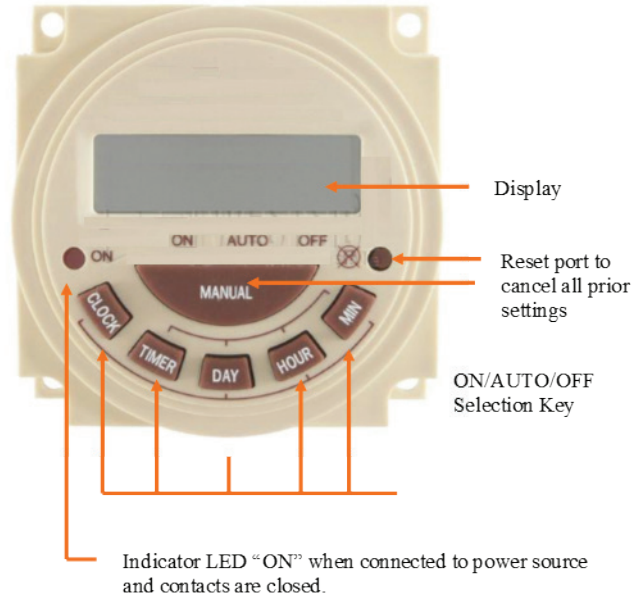

When programming is done, press the **CLOCK** key then the **MANUAL** key repeatedly until the indicator bar is above the word "AUTO"

To Review Program:

Press **TIMER** key repeatedly. When done, press **CLOCK** key to return to the time of day.

To Cancel/Change Part of the Program:

Press **TIMER** key repeatedly until the particular **ON** or **OFF** time appears, then repeatedly press the **DAY** key until the display shows " - - - - ". Set new **ON** and **OFF** time.

(See: To Set Programs)

To Override Automatic Operation:

Press **MANUAL** key to move indicator bar to the desired **ON** or **OFF** position.

Note: Timer will not resume automatic operation until indicator bar is repositioned above the word **AUTO**.

SAUNA MAINTENANCE

DAILY

- Wait for the sauna to cool before entering the sauna to conduct a cleaning
- Use a bucket of warm water with a mild detergent (a liquid soap is sufficient) and clean sponge or rag to wipe the bench surfaces.
- **Do not use petroleum-based detergents.** They can discolor your wood and will leave a residue which could emit irritating fumes.
- Wet mop the tile or cement floor.
- If something unpleasant other than ladled water is applied to the heater's rocks, clean them after they have completely cooled. Soak them in a soapy (light detergent) mixture of warm water. Wash off with a sponge, then rinse in clean water. Allow the rocks to dry, then re-apply rocks to the heater trough. Clean the heater and trough of the foreign substance. Gradually build heat in the sauna to totally dry the rocks.

WEEKLY

Take a rag and soapy water and wipe down benches and heavily used wall areas. (Do NOT take hose to sauna at any time.) Inspect benches for broken boards, tighten loose screws and make sure benches are firm.

There should be a thermometer/hygrometer in the sauna room at all times to show temperature and humidity for members safety.

EVERY 6 MONTHS–ONE YEAR *(DEPENDING ON USAGE)*

Take an orbital sander and lightly sand benches and walls to take off thin layer of discolored wood. Directly after use Scandia Essential Wood Oil and apply to sanded area. Wood oil comes in gallon jugs and can be purchased through Scandia's website.

HEATER CARE

WEEKLY

Remove and inspect all stones and clean the trough. If a stone is broken throw it away. If broken stones are allowed to remain in the trough they will break down into a sandy grit. That grit will eat a hole in the stainless steel. This damage is not covered by the warranty.

MONTHLY

Wipe down the heater shell to clean up any water stains.

**NEVER EVER TURN A HOSE ON THE SAUNA TO WASH IT DOWN.
IT WILL DAMAGE THE HEATER'S ELECTRIC COMPONENTS.**

ULTRA SAUNA - WARRANTY

Your Ultra Sauna heater has been engineered and built to the highest quality standards, and is backed by this warranty to assure your complete satisfaction:

- (1) SCANDIA Mfg warrants on the terms and conditions set forth below for ten years to the Original Owner only, at the Original Installation site only, this equipment to be free from defect in material and/or workmanship under normal use as specified in the equipment's instructions, FROM DATE OF PURCHASE and thereafter.
- (2) A TEN YEAR LIMITED WARRANTY applies only on the heater unit as manufactured by and at SCANDIA Mfg., - Manufacturing Plant – and specifically excludes all components and/or parts which are accessories therein, namely: the gas valve; pilot generator; heating element; contactor; timer switch; thermostat; and, high limit, for which their respective manufacturers warranties apply. The TEN YEAR LIMITED WARRANTY does not apply for units that have been installed in commercial locations such as clubs, condominiums, apartments, spas or military facilities. In commercial locations, Scandia will provide a one-year warranty on the unit.
- (3) During the first year SCANDIA will, at its option, repair or exchange at the Factory all parts which it finds have become inoperative during said warranty period due to a defect in material or workmanship, without cost to customer except for freight and/or crating charges.
- (4) For the period commencing with the second year and for the ten year warranty of the original purchaser only, at the original installation only, SCANDIA will, at its option, repair or exchange at the Factory, all parts which it finds have become inoperative during said warranty period due to a defect in material or workmanship except the following parts which are excluded from this warranty: the gas valve; pilot generator; heating element; contactor; timer switch; thermostat; and, high limit.
- (5) This warranty in its entirety becomes null and void if unit is rented or to be used for rental purposes or installed in any mobile or fixed prefab rental room. If original purchaser is a corporation then, the president of said corporation, shall be construed as registered Original Owner for all purposes herein, otherwise this warranty in its entirety becomes null and void.
- (6) This warranty in its entirety becomes null and void if unit has been installed by an unlicensed party by and/or in the city and/or county where installation is made. Furthermore if unit is disassembled and/or tampered with in any way possible by any one (individual and/or company) then this warranty in its entirety becomes null and void.

SCANDIA reserves the right to substitute new equipment or parts on any orders for replacement hereunder, but shall not be obligated to do so. This warranty is solely for the benefit of the original purchaser and no one else, and only if the installation and operating instructions applicable to the model purchased are followed. These instructions are furnished with the unit and also are available by writing SCANDIA's warehouse. These instructions are incorporated herein by reference as if set forth in full. This warranty does not cover damages which appear to SCANDIA to have resulted from neglect, alteration, abuse, misuse, accident, flood, fire or other act of force majeure, or other than normal use.

This warranty is expressly in lieu of other warranties, or liabilities, express or implied, by the Company or its representatives, and in lieu of all other obligations and liabilities for damage to persons or property caused in any manner by the heater or its component parts. More specifically, by not by way of limitation, SCANDIA assumes no liability for damages which may occur as a result of neglect or intentional misuse of the unit, and the purchaser or user of the unit agrees to assume all liability for the consequences of its use or misuse by such purchaser or user, and his, its or their respective employees and agents or other third person. THERE ARE NO WARRANTIES WHICH EXTEND BEYOND THE DESCRIPTION ON THE FACE HEREOF. NO REPRESENTATION OR WARRANTIES ARE MADE, EXPRESSED OR IMPLIED, OTHER THAN THOSE EXPRESSLY HEREIN SET FORTH TO THE ORIGINAL PURCHASER ONLY.

To obtain the benefits of this Warranty, the inoperative parts and/or complete heater must be sent to Scandia, all shipping and crating charges prepaid. And all repaired or replaced parts or heaters will be returned freight collect. This warranty is effective only when the attached Factory Registration Stub is completed and returned to the manufacturer. Please contact Scandia for return authorization at 877-467-2862 or via e-mail info@scandiamfg.com

Warranty stub must be mailed or completed online within thirty DAYS TO REGISTER AND VALIDATE THIS WARRANTY, WHICH BECOMES VALID ONLY IF THE HEATER HAS BEEN PURCHASED DIRECTLY FROM SCANDIA MFG., AND/OR AUTHORIZED DEALERS IN U.S.A., its territories or possessions.

TO VALIDATE WARRANTY VISIT WWW.SCANDIAMFG.COM/PRODUCT_REGISTRATION.HTML AND REGISTER YOUR PRODUCT. ALL PRODUCTS MUST BE REGISTERED PRIOR TO ANY WARRANTY CLAIMS.

Scandia Ultra Sauna Electric Heaters Trouble Shooting Guide

All service and repairs must be performed by certified personnel and must use Scandia certified components.

In order to effectively troubleshoot your Scandia Ultra Sauna heater, it is important to check the parameters of the installation first. Please check the below points and proceed based upon your answers. This guide should lead you to the exact problem of your heater and suggest the most efficient resolution to the problem.

Check the following:

1. If the appropriate breaker in the circuit panel is in the on position.
 - If no: turn it on.
 - If yes: check #2.
2. Make sure the base of the heater is at least 10" from the floor of the sauna.
 - If no: reposition the heater to the correct height.
 - If yes: check #3.
3. When turning sauna on, with the timer on, turn thermostat on then off, make sure you hear the thermostat engaging the heating system (you will hear a click or clunk sound).
 - If no: go to **Thermostat Section**
 - If yes: check #4.
4. Heater guard-rail is not blocking airflow of the heater (at least 6" from out-vents)
 - If no: realign heater guard-rail to appropriate parameters.
 - If yes: check #5.
5. Sauna room is vented with one intake vent located below the heater and one exhaust vent located on the other side of the room below the upper bench or at least knee high.
 - If no: install appropriate venting
 - If yes: check #6.
6. Fuses in the fuse box are blown (for 15 and 18 KW versions only).
 - If fuses are blown: replace appropriate fuses
 - If not: check #7.
7. Check that each element is supplied by opposing phases (or leads). A heater element cannot be supplied by the same phase. This will destroy the element.
 - If no: contact an electrician or the original installer to correct the wiring sequence immediately. This condition can result in serious damage to your heater and possible fire hazard.
 - If yes: Go to **High-Limit Section**

PLEASE PROVIDE THE FOLLOWING INFORMATION:

1) Breaker amp rating:

2) Heater distance from floor:

3) Circle the sound made when
engaging the heating system:

Click / Clunk

4) What is the guard rail distance
from the heater:

5) Describe ventilation:

6) Fuse amp rating:

7) Describe phase sequence:

High Limit Section

Please check all seven parameters on page one of this guide before proceeding to this section.

The high-limit switch is located at the base of the sauna heater body. The red button protrudes from the bottom junction box. This red button resets the high-limit switch when tripped. The high-limit switch is a safety feature that shuts down your sauna when the timer and thermostat fails to shut down the heater. If the high-limit switch is turning off your heater, this means your thermostat is not controlling the temperature as it should – or – the high-limit switch is turning off your heater prematurely (before the thermostat turns it off).

Note: Before proceeding, make sure you have tested the thermostat as described in step #3 on the cover page.

If your high-limit switch is prematurely shutting down your heater, therefore not allowing your thermostat to regulate the heat, your high-limit sensor bulb may need to be adjusted. Please call our technical support team to help with this issue.

Thermostat Section

Please check all seven parameters on page one of this guide before proceeding to this section.

The thermostat can be located on the control panel outside of the sauna room or directly at the base of the sauna heater. The thermostat controls the temperature of the room. Because of varying room constructions, room sizes, materials, altitudes ... the thermostat works on a 1 to 10 basis rather than an actual temperature reading. The 10 setting on the temperature should be equivalent to 180 – 190 degrees Fahrenheit. If the sauna heater is being turned off (or controlled) by the high-limit (not thermostat), this does not mean your thermostat is faulty, it could be that your high-limit switch must be adjusted. If so, see high-limit section of this guide.

Thermostat Integrity Check – to check thermostat functionality: reset high-limit (only if tripped) and turn on sauna timer (if equipped with a 24 hour timer, make sure it is on). When the sauna heater is on, turn up and down the thermostat and determine at which number the thermostat engages the system (you will hear a click or clunk sound). Wait 10 minutes and check which number on the thermostat engages the system. If the number increases as the room gets warmer your thermostat is working properly.

IF THE THERMOSTAT DOES NOT ENGAGE THE SAUNA SYSTEM:

1. Check all seven parameters on page one of this guide.
2. Check wires to make sure all connections to the thermostat, timer and contactors are snug.
 - If not – tighten all connections
 - If yes – go back to the first page of the guide and check step #3
3. Make sure thermostat copper capillary wires are not crimped or bent.
 - If crimped – thermostat must be replaced
 - If not crimped – go back to the first page of the guide and check step #4

CONFIRMING A FAULTY THERMOSTAT

Turn the sauna off and shut off all power connections, then bypass the thermostat by connecting the two thermostat lead wires from the controls together. Once done, restore power and turn on the timer. If the heater system turns on, this confirms your thermostat is faulty.

This is to be done for testing purposes only and by a licensed electrician.

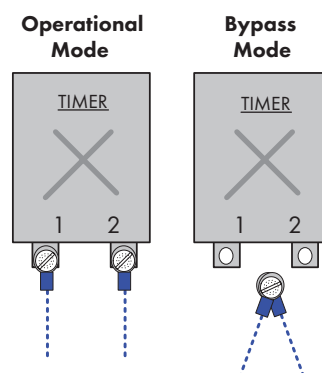

Timer Section

Please check all seven parameters on page one of this guide before proceeding to this section.

The Scandia Ultra Sauna heater comes with two types of timers, a 60 minute timer or a 24 hour timer. The timer works in partnership with the thermostat. In order to operate the sauna heater, both the timer and thermostat must be turned on in order to activate the heater. When on the timer only allows the heater to be controlled by the thermostat. Said another way, the timer will not turn on the heater unless the thermostat is turned up. Inversely, the thermostat cannot turn on the sauna without the timer turned on. If the timer and the thermostat are turned on and the sauna does not turn on, this does not mean that your timer is faulty.

TIMER INTEGRITY CHECK

To check timer functionality: reset high-limit (only if tripped) and turn on sauna thermostat to #10 setting. (if equipped with a 24 hour timer, make sure it is off). Next, turn on the timer to see if it engages the system (you will hear a click or clunk sound).

IF THE TIMER DOES NOT ENGAGE THE SAUNA SYSTEM:

1. Check all seven parameters on page one of this guide.
2. Check wires to make sure all connections to the thermostat, timer and contactors are snug.
 - If not – tighten all connections
 - If yes – go back to the first page of the guide and check step #3
3. Make sure thermostat copper capillary wires are not crimped or bent.
 - If crimped – thermostat must be replaced
 - If not crimped – go back to the first page of the guide and check step #4

CONFIRMING A FAULTY TIMER

Turn the sauna off and shut off all power connections, then bypass the timer by connecting the two timer lead wires from the controls together. Once done, restore power and turn on the thermostat. If the heater system turns on, this confirms your timer is faulty. This is to be done for testing purposes only and by a licensed electrician.

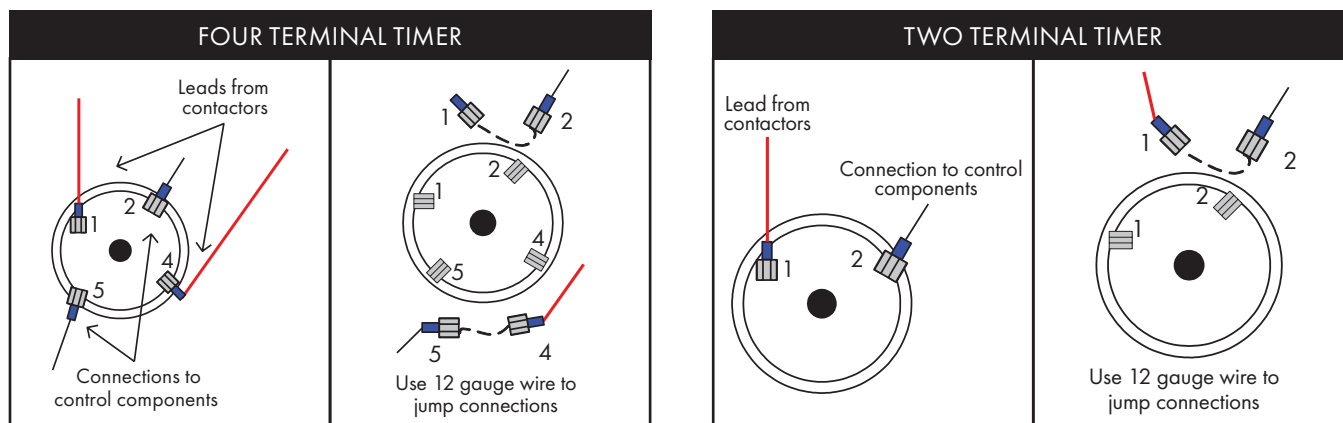

Temperature Adjustment Section

This section is for troubleshooting a heater that does not reach temperature.

The thermostat is the only switch that controls the temperature of your sauna heater. The thermostat only works when the timer is on. The thermostat will be disabled and the heater will not turn on if the high-limit switch has been tripped (see high-limit section). If the high-limit switch is turning shutting down your heater, this means your thermostat is not controlling the temperature as it should – or – the high-limit switch is turning off your heater prematurely (before the thermostat turns it off).

Note: It is required to continuously monitor the room’s temperature progression during these steps.

1. First Cycle: turn sauna timer on and turn thermostat to 10 setting.
(If heater does not turn on, the high limit will need to be re-set).
2. Cool Down: With heater still on, wait until the heater unit turns off
notating time elapse (from start) and temperature at which the unit shut down.
3. Second Cycle: wait until heater re-starts (normally 10 – 15 minutes).
Notate time elapse (from when heater turned off) and temperature which
the unit restarted.

Note: if the heater unit did not restart, press the high-limit button and then consult the high-limit section of this guide.

4. Contact Scandia Manufacturing Technical Service Department
with the following data.

CYCLES	TEMPERATURE	TIME LAPSE
FIRST CYCLE		
COOL DOWN		
SECOND CYCLE		