



*The best brands, the best products.*

*Your one stop shop for all sauna and steam needs.*

## Our Contact Information



1-888-503-8157



info@saunas.com

By providing superior service, providing a vast array of high-quality products, Saunas.com is the Internet's premier supplier of saunas, steam equipment, and accessories. We strive to make your visit at our website a fun and educational experience as well as a smooth purchase should you decide to honor us by buying a product. We hope you find a sauna to your liking, and many years of satisfying saunas in the future!

Please don't hesitate to call or email us with any questions you may have!

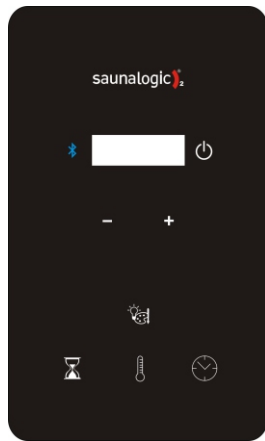

SL2 60 Min  
(1601-38)

SL2 24 Hr  
(1601-38-1)

**Sauna Control Models SL2 (SaunaLogic 2)  
(Model # 1601-38 & 1601-38-1)  
(Controls hereafter referred to **SL2-Series**)**

Read all instructions carefully before use.

**WARNING**

*Prolonged exposure to elevated temperatures is capable of inducing hyperthermia. Hyperthermia occurs when the internal temperature of the body reaches several degrees above the normal body temperature of 98.6°F. The symptoms of hyperthermia include an increase in the normal temperature of the body, dizziness, lethargy, drowsiness, and fainting. The effects of the hyperthermia include failure to perceive heat, failure to recognize the need to exit the room, unawareness of impending hazard, fetal damage in pregnant women, physical inability to exit the room and unconsciousness.*

**WARNING**

*The use of alcohol, drugs, or medication is capable of greatly increasing the risk of fatal hyperthermia.*

**SECTION 1: GENERAL INFORMATION**

These controls are ETL approved by Intertek for permanent installations and electrical connections. Refer to the heater "**Installation and Operating Instructions**" for complete information about the electrical wiring and heater installation.

**WARNING**

*Do not take a sauna if using alcohol, drugs or medications.*

*Pregnant women or persons with poor health should consult their physician before using any sauna.*

*Caution fire hazard: Do not use the sauna room for drying clothes, bathing suits, etc. Do not hang towels above heater or place any object other than the rocks supplied on the heater. If any darkening of the wall around the heater is noticed discontinue sauna use immediately.*

*Inspect sauna regularly for required maintenance to heater, control and benches. Replace wood surfaces which show any signs of deterioration.*

*The heater gets extremely hot during operation and should not be touched or burns may result.*

*Minors should be adequately supervised whenever near a hot or warming sauna.*



## SECTION 2: OPERATION

The SL2 Control is intended to be connected to the following CB Boxes: CB 13-1 or CB 14-1, or CB 15-1 or CB 16-1 or CB 16-3.

For health and fire safety, never attempt to alter or bypass the timer or thermostat. If the sauna is to be used without an automatic timer provided, (Model SL2 24 Hr (1601-38-1) Control Panel) an attendant must be present at all times.

### MODEL SL2 60 MIN CONTROL PANEL,

Press the SL2  icon once. The default settings for the temperature is 194°F, the bath time is 60 minutes. These settings are adjustable (as described below) from 119° to 194°. Length of sauna can be set from 0 to 60 minutes. The time delay before start can be up to 24 hours. Any changes are remembered by the heater for your next bath. Should the heater power be lost then restored, the settings will return to their default values.

### SETTING THE DURATION AND TEMPERATURE

Press the  icon for time "+" or "-" icon on the SL2 to increase or decrease time for desired setting. The maximum of time is 60 minutes.



Press the  icon and then press "+" or "-" icon on the SL2 to increase or decrease temperature for desired setting. The maximum temperature is 194°F (90°C).

Note: Typical bathing temperature is 150F to 165F displayed on the control.

### PRE-SET DELAYED START

Press the  icon and delay time will appear in the display and will toggle between “dlay” the amount of time remaining. The maximum of time is 24 hours. If no delay is desired, press button to toggle off the function.

### LIGHTING OPERATION (Optional)

Press the  icon to cycle through lighting options. Press and hold the  icon for 3 seconds to turn off the light from during any color. Light will automatically turn off after 10 minutes the sauna cycle is completed.

Color sequence – White – Red – Green – Blue – Yellow – Aqua –  
Purple – Rotation of Colors - Off

Choose the color of choice and then set lighting brightness. The brightness will be on display for 3 seconds. Press the “+” or “-“ button to increase or decrease the light setting. The setting options are 25, 50, 75, and 100% light output.

## WARNING

*Fire sprinkler systems used inside any sauna room should be properly rated for sauna room temperatures.*

*Do not pour chlorinated pool or spa water on heater. Excessive water use on heater may cause damage and void warranty.*

*Do not install a shower in sauna room.*

*Electric Shock Hazard - High voltage exists within this equipment. There are no user serviceable parts in this equipment. All installation and service to this equipment should be performed by qualified licensed personnel in accordance with local and national codes.*

*Do not construct sauna room so as to restrict air flow through the bottom of the heater.*

*Packing the rocks too tightly may cause the heater high limit switch to trip.*

## SECTION 3: OPERATION, Continued

### MODEL SL2 24 HR CONTROL PANEL,

Press the SL2  icon once. The default settings for the temperature is 194°F, the bath time is 24 Hours. An attendant must be present at all times for extended period of time operation.

Refer to the “Setting Time and Temperature” for information about how to adjust the settings.

### DIAGRAM 1

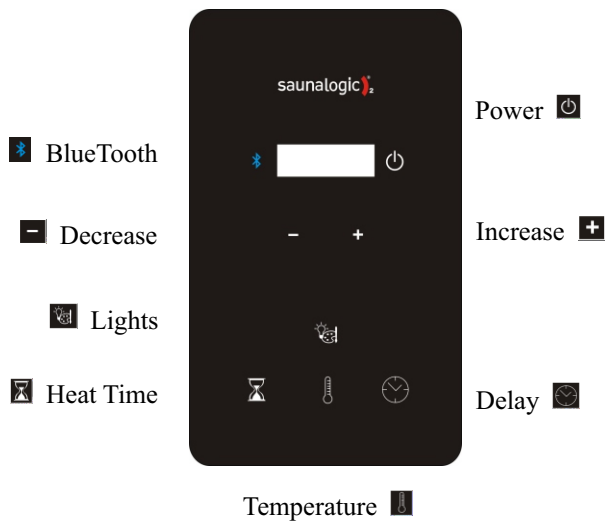

### DIAGRAM 2

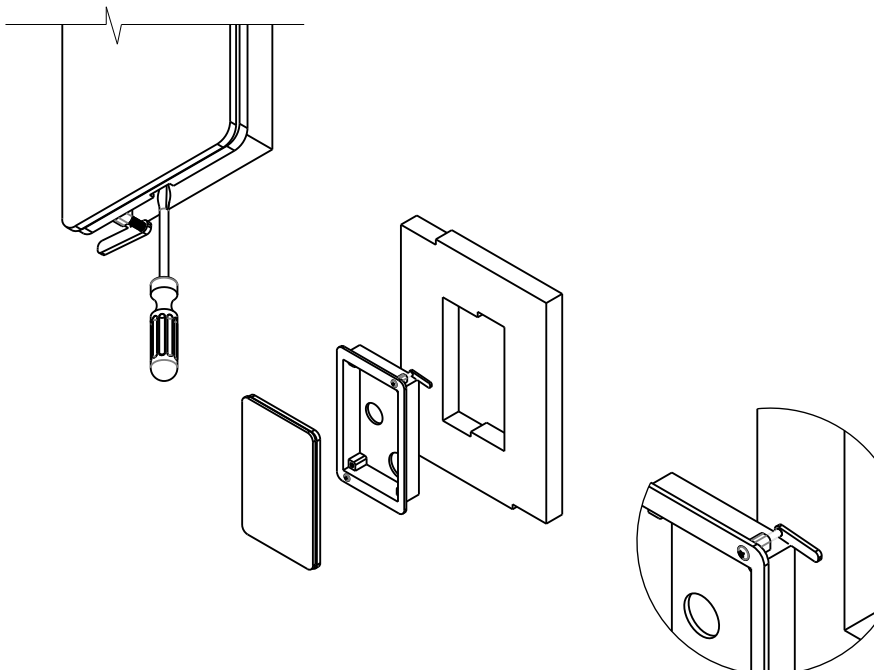

Shower



Sauna (10 - 15 min.)



Shower or swim



Rest (10 - 15 min.)



Relax with juice or water

You liked it?  
Do it once again and  
you will feel great.

## SECTION 4: HOW TO TAKE A SAUNA

- When taking a sauna, allow time to relax completely.
- Remove clothing and jewelry...if required, wear a towel loosely.
- After 10 minutes or when perspiration begins, leave sauna and relax in dressing area, follow with a cool shower.
- Cooling time should equal time spent in sauna. Enter sauna room again and stay 5 or 10 minutes.
- Repeat the cycle 2 or 3 times; end with a brisk shower...rinse in cool water.
- Dress when completely dry and perspiration has stopped.
- Some sauna bathers enjoy the soothing effect of steam by splashing water on the heated sauna rocks. Use only one dipper full (approx. ½ cup) at a time and take care to keep clear of the steam as it rises off the rocks.
- Do not smoke, exercise or drink alcoholic beverages in the sauna room.
- Do not pour chlorinated pool or spa water on the heater or corrosion damage may result.

## SECTION 5: MAINTENANCE

The sauna, like a bathroom, should be kept clean and odor free.

Towels or mats should always be used on benches and floor as perspiration otherwise penetrates the soft wood.

Air out the sauna often by keeping the door and vents open when the sauna is not in use. Saunas that are in daily use should be washed down at least once a week to keep them clean and the air fresh. Duckboard should be removed from the sauna, the sauna floor mopped and dried in a conventional manner, and the duckboard thoroughly scrubbed and dried before returning to the sauna room. The sauna heater should be wiped down occasionally with a damp cloth to remove lint and dust. The rocks should be removed once a year for cleaning and small or crumbled rocks replaced.

To clean and remove perspiration stains, use soap or detergent in warm water, best applied with a scrub brush. Badly soiled surfaces may require sanding. Sand paper wrapped around a wooden block works well.

Benches and supporting structure must be inspected annually for potential deterioration due to age, dry rot or abuse. Any boards with signs of deterioration should be replaced immediately to avoid possible injury.

## SECTION 6: TROUBLESHOOTING

If control displays "Sn" it means no sensor is connected. Refer to Section 5 for sensor installation information.

If control displays "HL" it means the high limit is open. Refer to Section 9 for high limit information.

System won't start to heat, ensure the system is not in the delay mode. If "dLAY" is flashing in the display window, the system is in the delay mode.

If control displays "JP" it means the jumper is open on the main board in the CB Box. Verify jumper is installed in CN7 location on the main board. If it is open, close the two pins.

For troubleshooting or service questions call 1-888-780-4427 and ask to speak with service. Prior to calling, please have the Model and Type number available. You may also email us at [techsupport@tyloheloinc.com](mailto:techsupport@tyloheloinc.com)