

DIATONE® ROMA L4 机架组装示意图

Longrange ROMA L4 Frame Assemble Diagram

作为ROMA系列的首款轻量型设计, ROMA L4 长续航机架仅重46g, 4inch轻巧便携, 搭配18650电池组, 最长飞行时长达35分钟。并且装配GPS模块, 长航时远距离飞行不再是大尺寸飞行器专属。同时也兼容了ROMA系列的GoPro可调支架注塑件的安装孔位, 增加了通用机型的可玩性。

As the ROMA series' first lightweight design, the ROMA L4 long-endurance frame weighs only 46g. It's a light and portable 4-inch design, best flown with a 18650 battery pack to get up to of 35 minutes flight-time. Equip ROMA L4 with a GPS module, and long-distance flight is no longer exclusively for large-sized aircrafts. The L4 frame is compatible with all injection molded parts in the ROMA series, including the adjustable GoPro mount.











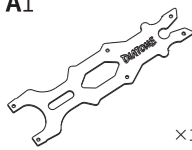
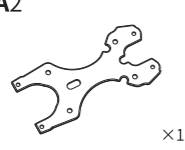

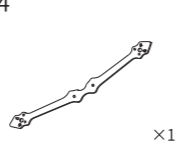
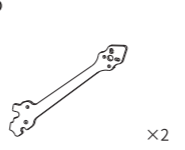
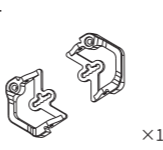

产品规格

Product Specifications

机架类型: 异型	对角轴距: 176mm	机架净重: 46g	上板厚度: 1.5mm
中板厚度: 1.5mm	底板厚度: 1.5mm	机臂厚度: 3mm	机臂宽度: 6.5mm
对角孔距: 9/12mm (M2)	卡簧孔径: \varnothing 4mm	设备层高: 20mm	支持最大桨叶: 4inch
摄像头间距: 20mm	推荐电池: 3S~4S	推荐电机: 13-14系列电机	飞控孔距: 20*20 (M2)/25.5*25.5 (M2)
Frame Shape: Hybrid	Motor to Motor: 176mm	Frame Net Weight: 46g	Top Plate Thickness: 1.5mm
Medium Plate Thickness: 1.5 mm	Bottom Plate Thickness: 1.5mm	Arm Thickness: 3mm	Am Width: 6.5mm
Motor Hole Distance: 9/12mm (M2)	Bore Diameter of Snap Ring: \varnothing 4mm	Max Stack Height: 20mm	Supported Prop Size: 4 inch
Camera Spacing: 20mm	Recommended Lipo: 3S-4S	Recommended Motor Size: 13-14 Series motor	
FC Stack Mount: 20*20mm(M2)/25.5*25.5mm(M2)			

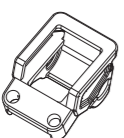
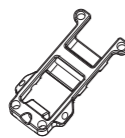
配件清单

Parts list

A1  顶板 Top plate ×1	A2  底板 Bottom plate ×1	A3  中板 Medium plate ×1	A4  前机臂 Front Arm ×1	A5  后机臂 Back Arm ×2	B1  机头铝件 Camera aluminum bracket ×1
B2  M2x19mm 铝柱 M2x19mm Alum standoff ×5	B3  M2x20mm 铝柱 M2x20mm Alum standoff ×2	C1  M2 x4mm 内六角螺丝 M2 x4mm hex screw ×6	C2  M2 x6mm 内六角螺丝 M2 x6mm hex screw ×8	C3  M2 x11mm 内六角螺丝 M2 x11mm hex screw ×6	C4  M2x18mm 十字螺丝 M2x18mm cross screw ×6
C5  M2.5 x7mm 内六角螺丝 M2.5 x7mm hex screw ×6	D1  TBS/GPS 打印件 TBS/GPS 3D-printed part ×1	D2  2.4G天线座打印件 2.4G Antenna 3D Printed Mount ×1	D3  电池防滑垫 Lipo anti-slip pad ×1	D4  GoPro 可调座 GoPro adjustable mount ×1	D5  2.4G天线保护 2.4G antenna protector ×2

安装步骤

Assembly Guide

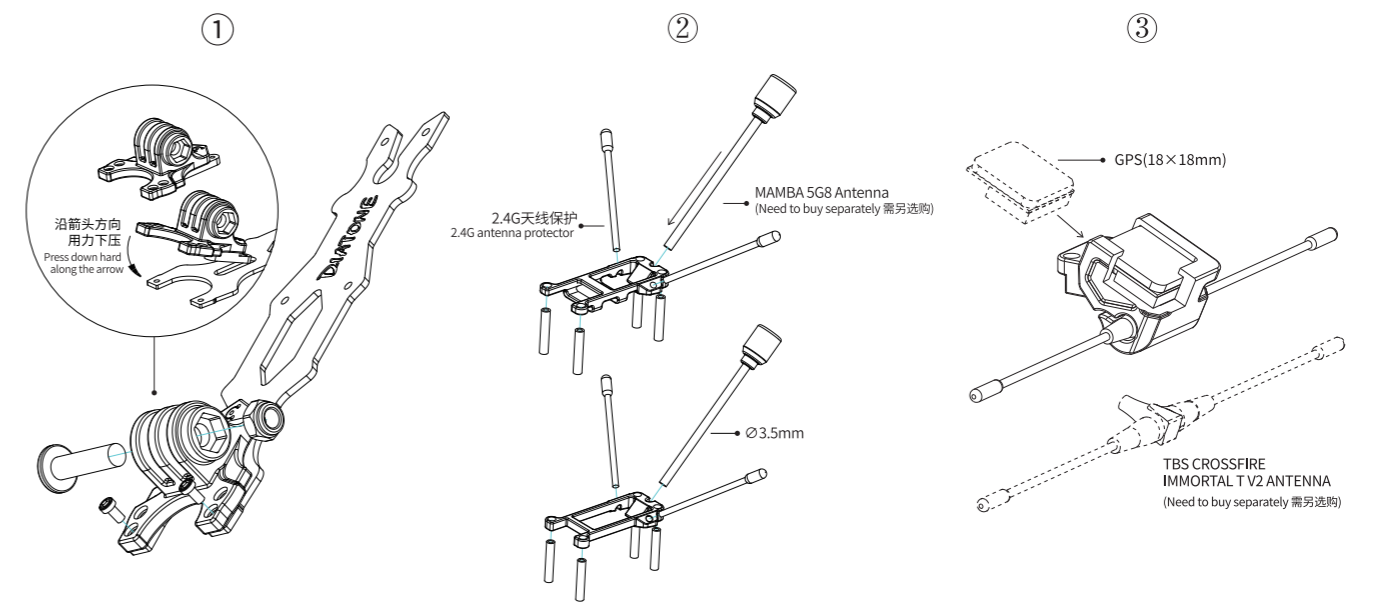
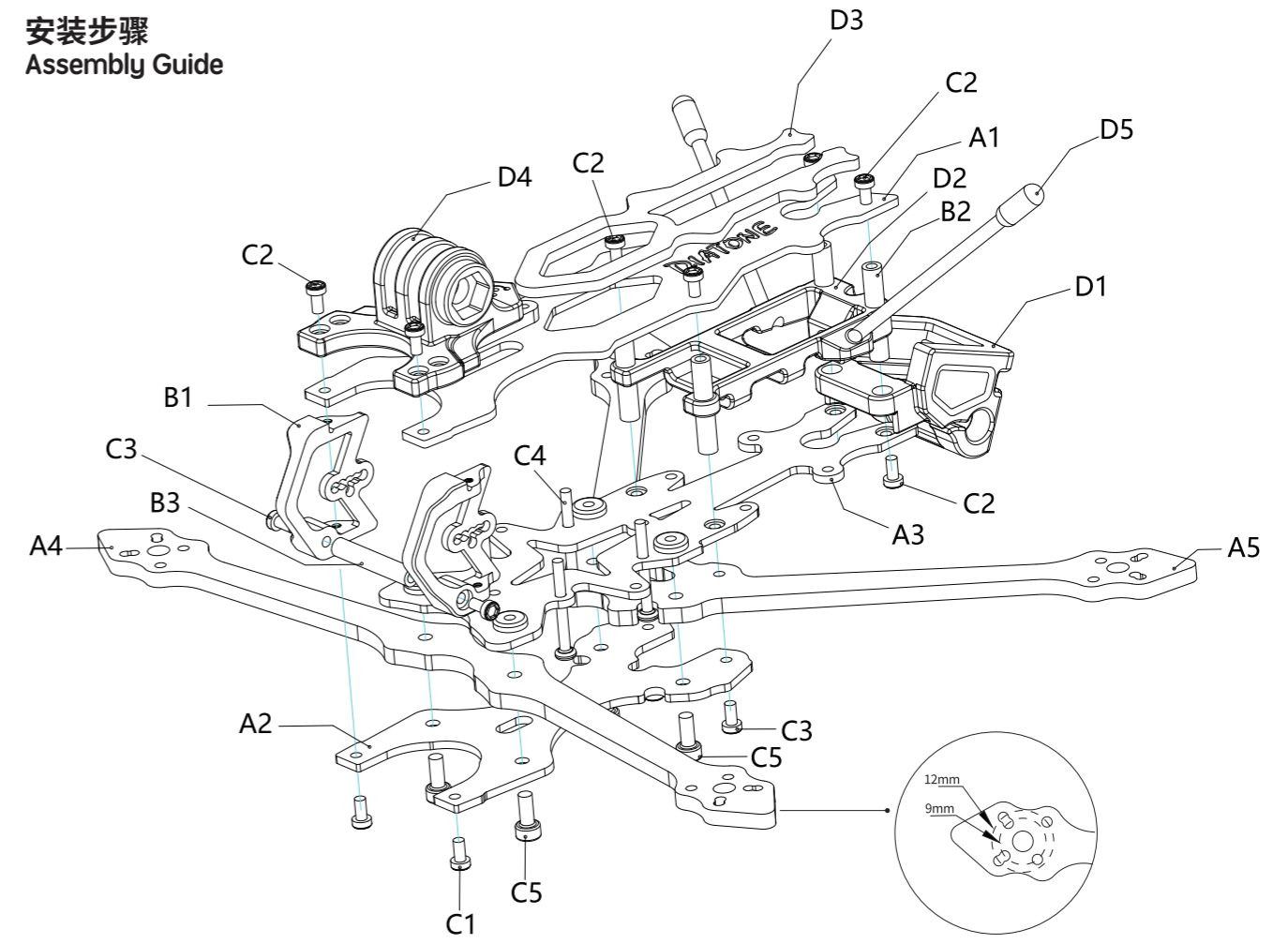

更详细的信息, 可通过访问DIATONE官网获得
For more information, please refer to the Diatone official website

DIATONE®
We provide outstanding service since 2012

Manufacturer : Diatone Innovation Designed by Sniclo.
Tel : (+86) 0769-82100057 Web : www.diatone.us
Address : Baijiayi Technology Park A-3, Yantian, Fenggang, Dongguan, Guangdong, china

DIATONE® ROMA L3 机架组装示意图

Longrange ROMA L3 Frame Assemble Diagram

ROMA L系列3英寸长续航机型,轻巧便携仅重43g,小场地的畅飞不再是梦。满足搭配轻量高清视频设备,获得更好的飞行感受。设计风格上沿用系列的可调注塑件,提高了产品的兼容性。

The ROMA L Series 3" is a model primed for long-range flights in the smallest, most compact, and lightweight package possible. Weighing only at 43g, the ROMA L Series 3" makes flights in a tight area a reality. This series features HD-footage capabilities for the best flying experience. Since Diatone aims for compatibility across the board, owners of other ROMA models can use the injection-molded parts interchangeably with the ROMA L3".











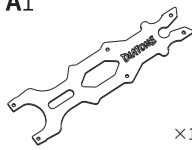
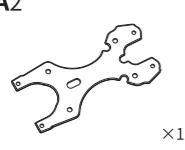

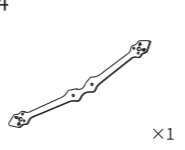
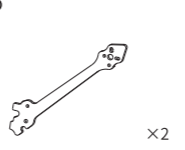
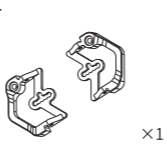

产品规格

Product Specifications

机架类型: 异型	对角轴距: 147mm	机架净重: 43g	上板厚度: 1.5mm
中板厚度: 1.5mm	底板厚度: 1.5mm	机臂厚度: 3mm	机臂宽度: 6.5mm
对角孔距: 9/12mm (M2)	卡簧孔径: \varnothing 4mm	设备层高: 20mm	支持最大桨叶: 3 inch
摄像头间距: 20mm	推荐电池: 3S~4S	推荐电机: 12系列电机	飞控孔距: 20*20 (M2)/25.5*25.5 (M2)
Frame Shape: Hybrid	Motor to Motor: 147mm	Frame Net Weight: 43g	Top Plate Thickness: 1.5mm
Medium Plate Thickness: 1.5 mm	Bottom Plate Thickness: 1.5mm	Arm Thickness: 3mm	Am Width: 6.5mm
Motor Hole Distance: 9/12mm (M2)	Bore Diameter of Snap Ring: \varnothing 4mm	Max Stack Height: 20mm	Supported Prop Size: 3 inch
Camera Spacing: 20mm	Recommended Lipo: 3S-4S	Recommended Motor Size: 12 Series motor	
FC Stack Mount: 20*20mm(M2)/25.5*25.5mm(M2)			

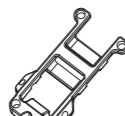
配件清单

Parts list

A1  顶板 Top plate ×1	A2  底板 Bottom plate ×1	A3  中板 Medium plate ×1	A4  前机臂 Front Arm ×1	A5  后机臂 Back Arm ×2	B1  机头铝件 Camera aluminum bracket ×1
B2  M2x19mm 铝柱 M2x19mm Alum standoff ×5	B3  M2x20mm 铝柱 M2x20mm Alum standoff ×2	C1  M2 x4mm 内六角螺丝 M2 x4mm hex screw ×6	C2  M2 x6mm 内六角螺丝 M2 x6mm hex screw ×8	C3  M2 x11mm 内六角螺丝 M2 x11mm hex screw ×6	C4  M2x18mm 十字螺丝 M2x18mm cross screw ×6
C5  M2.5 x7mm 内六角螺丝 M2.5 x7mm hex screw ×6	D1  TBS/GPS 打印件 TBS/GPS 3D-printed part ×1	D2  2.4G天线座打印件 2.4G Antenna 3D Printed Mount ×1	D3  电池防滑垫 Lipo anti-slip pad ×1	D4  GoPro 可调座 GoPro adjustable mount ×1	D5  2.4G天线保护 2.4G antenna protector ×2

安装步骤

Assembly Guide

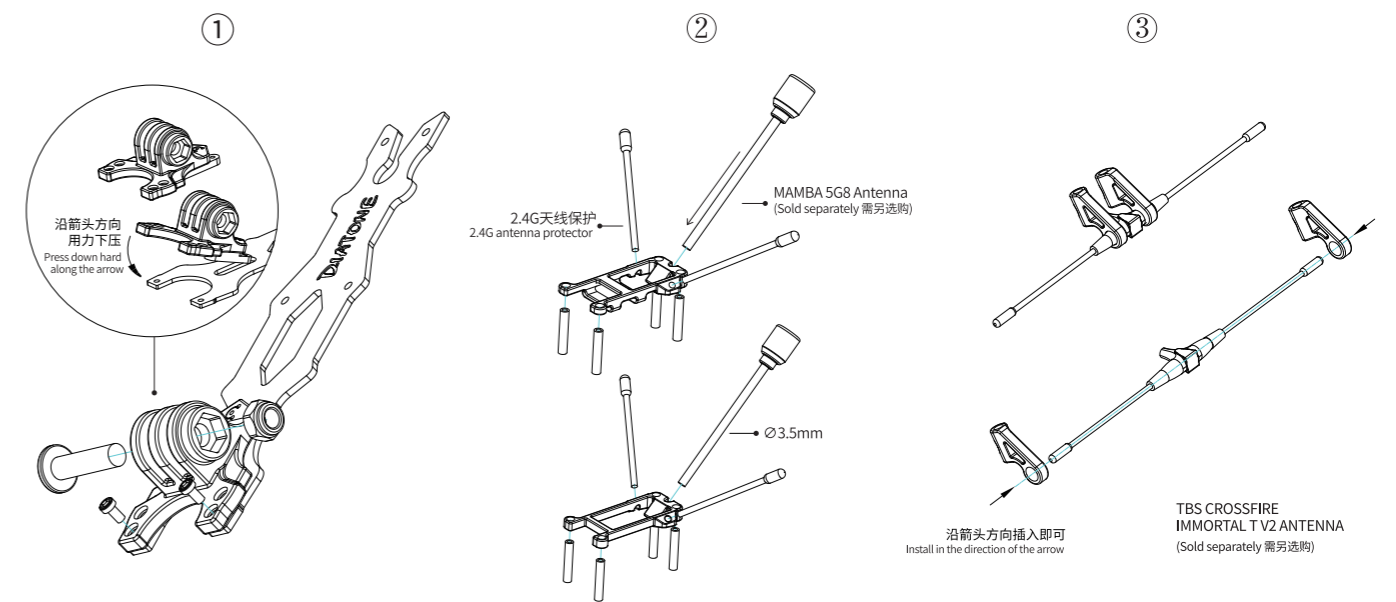
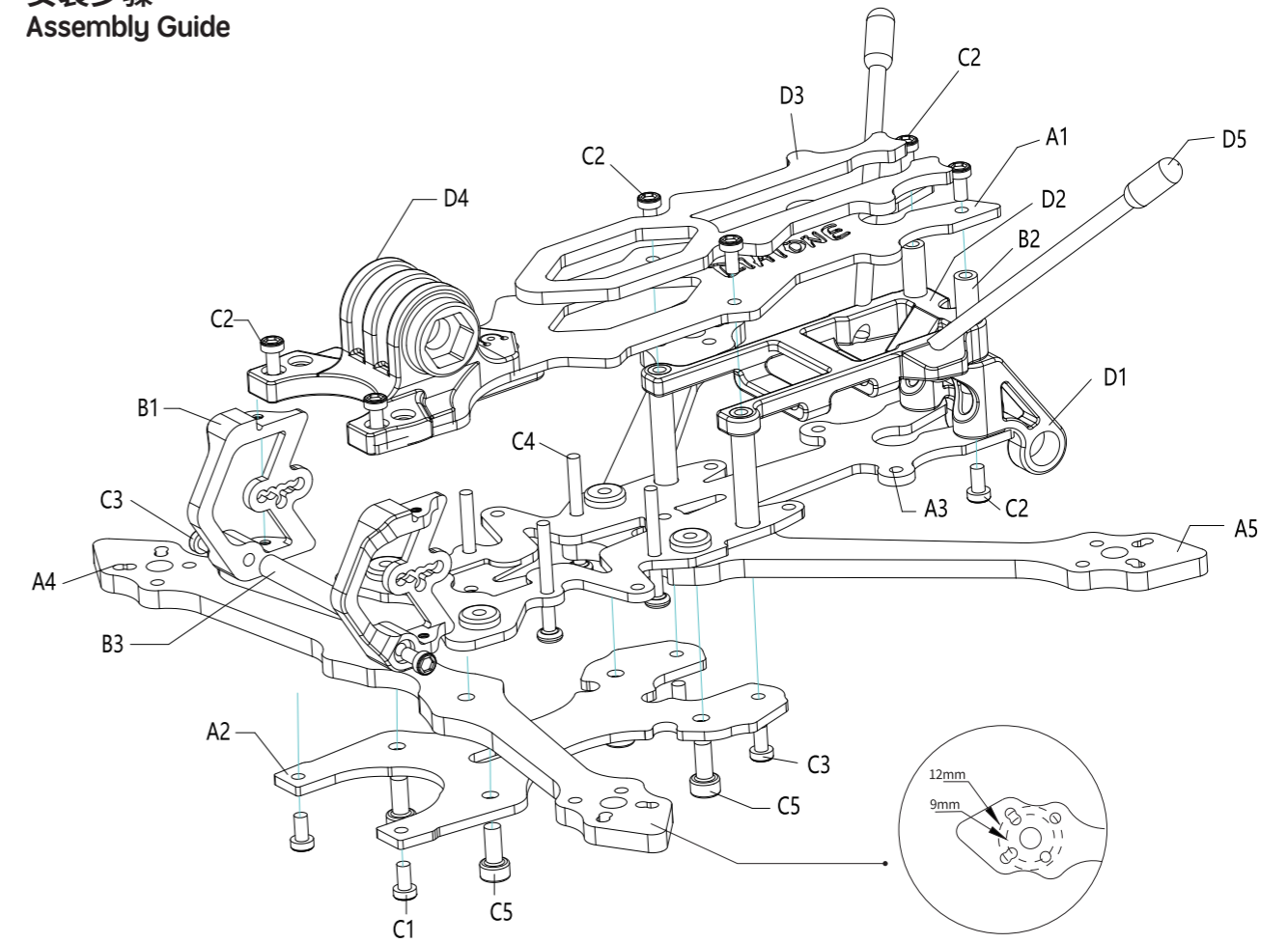

更详细的信息, 可通过访问DIATONE官网获得
For more information, please refer to the Diatone official website

DIATONE®
We provide outstanding service since 2012

Manufacturer : Diatone Innovation Designed by Sniclo.
Tel : (+86) 0769-82100057 Web : www.diatone.us
Address : Baijiayi Technology Park A-3, Yantian, Fenggang, Dongguan, Guangdong, china

成品尺寸:400mm*297mm

出血位:红色虚线,3mm

文件比例:1:1

单位:mm

纸张:105g 铜版纸

折式:风琴折再对折

时间:2021-03-17