

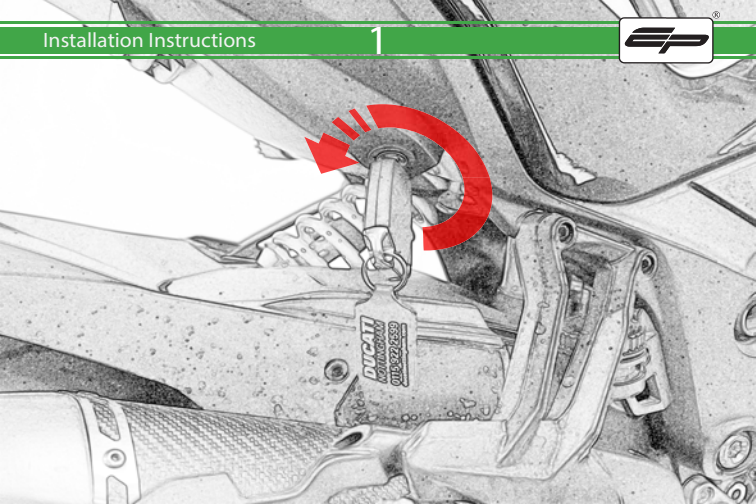

### Kit Contents PRN014618

- (A) 1 x Reflector Kit
- (B) 2 x M5 x 16mm Black Button Head Bolt
- (C) 2 x M5 x 10 C/Sink Screw
- (D) 2 x Indicator Clamp Plate
- (E) 4 x M6 Flange Nuts
- (F) 4 x Large Top Hat Washers
- (G) 4 x Small Top Hat Washers
- (H) 4 x M6 x 16 Black Button Head Bolt
- (I) 4 x Indicator Clamps
- (J) 8 x M5 x 12mm Black Button Head Bolt
- (K) 10 x Cable Ties

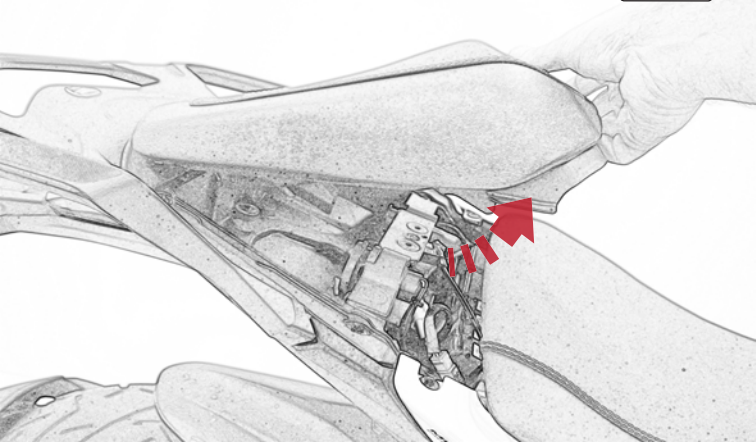



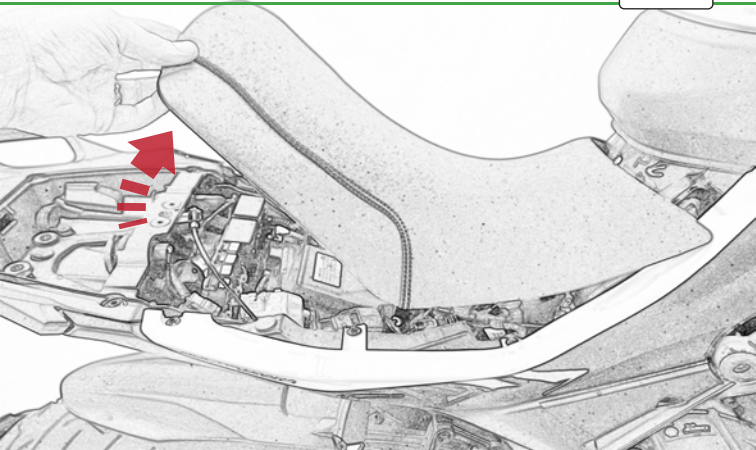

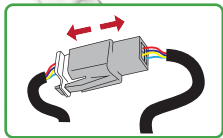
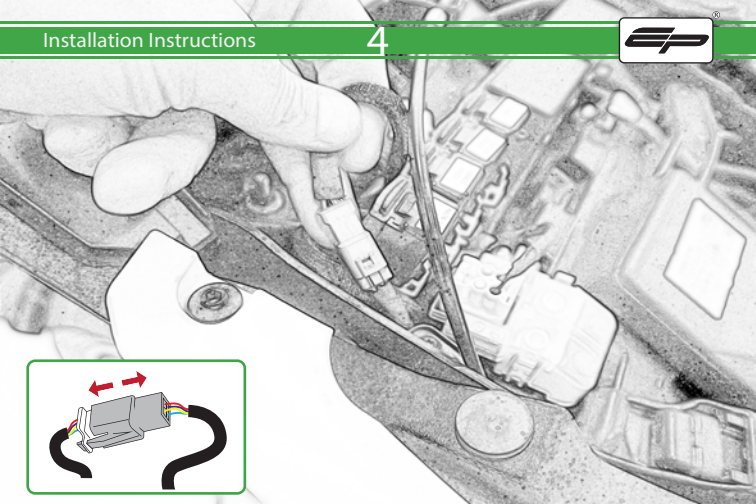

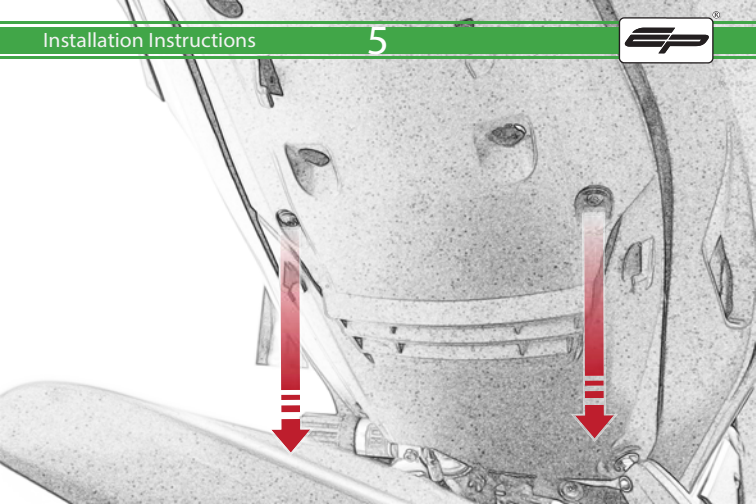

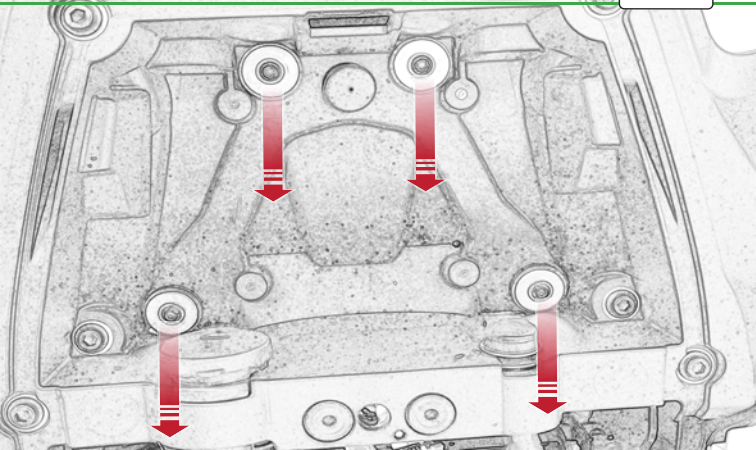

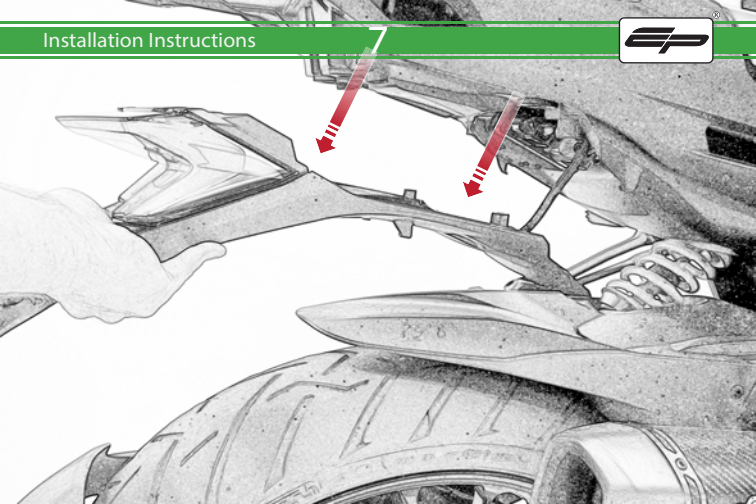



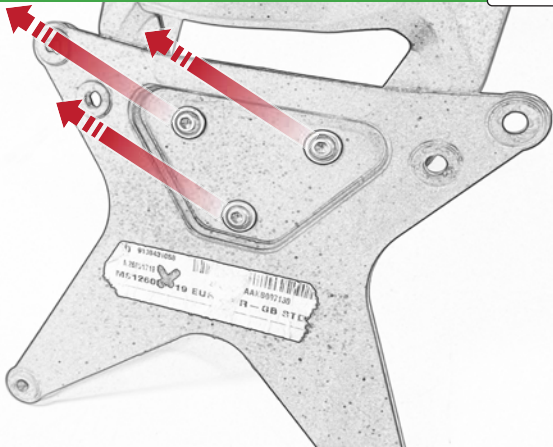

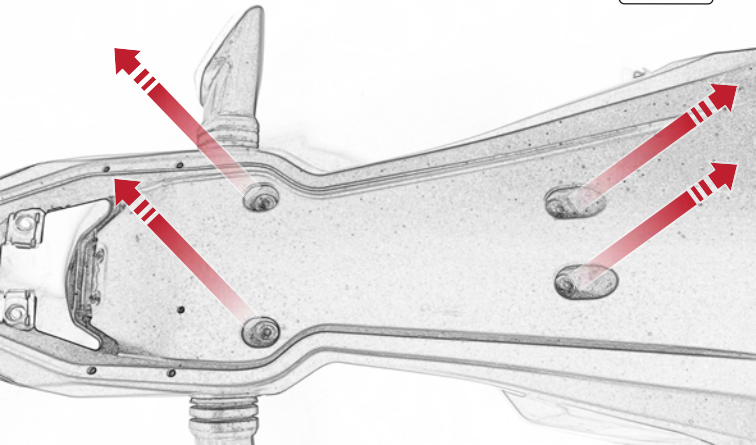

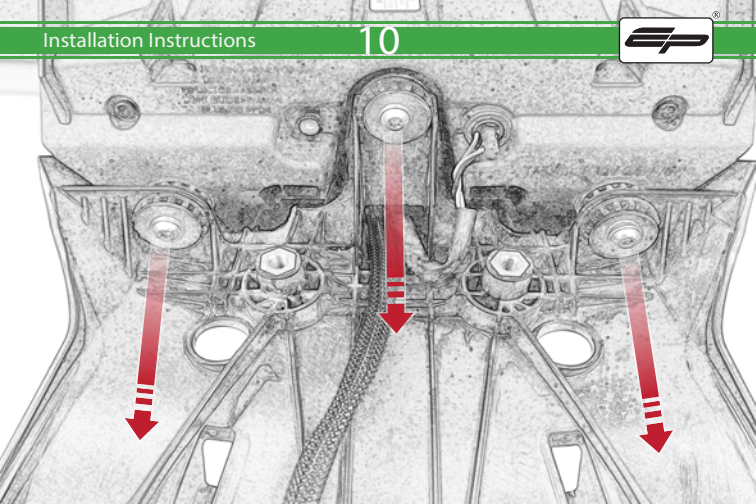

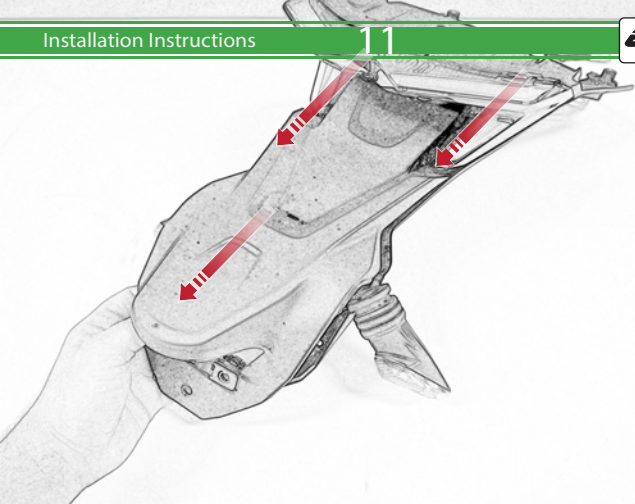

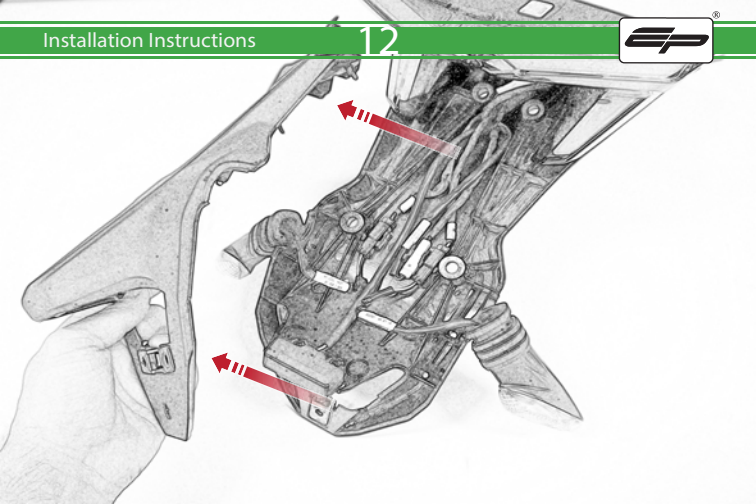

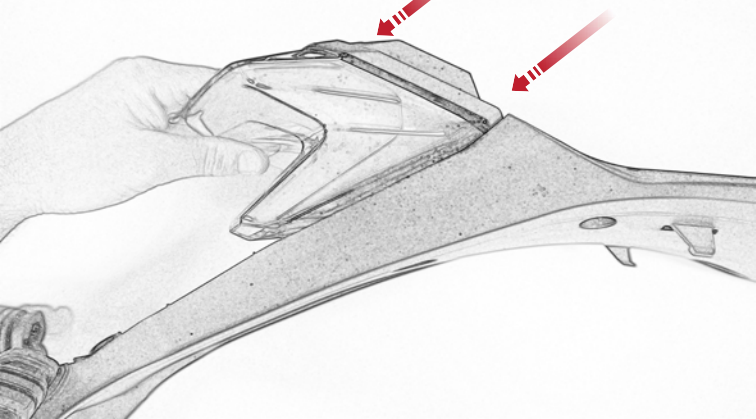

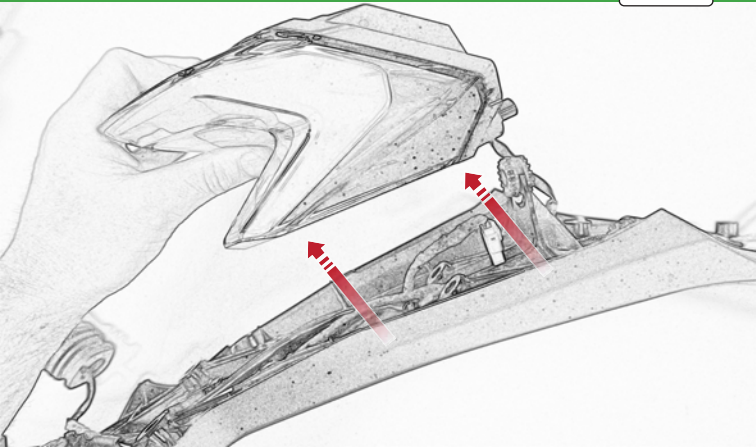

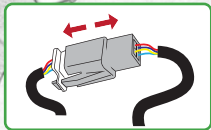
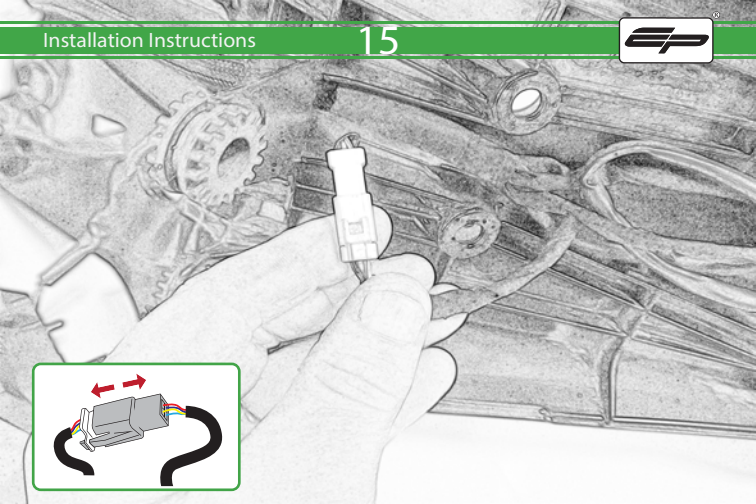



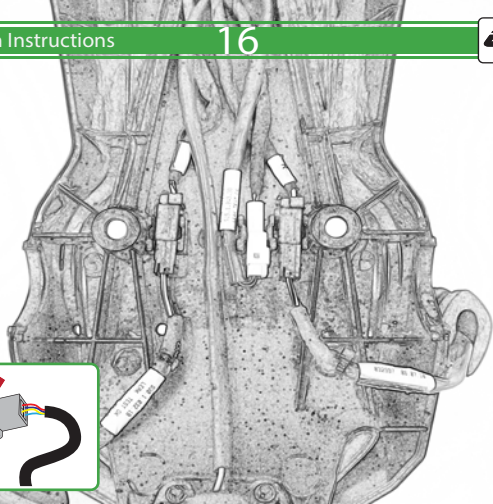
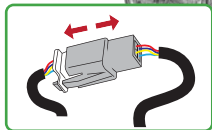

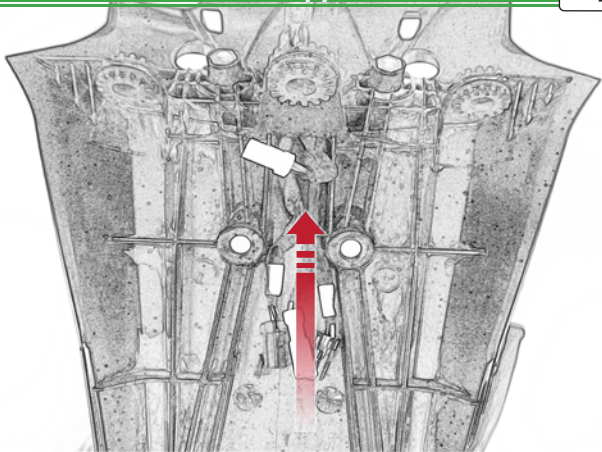

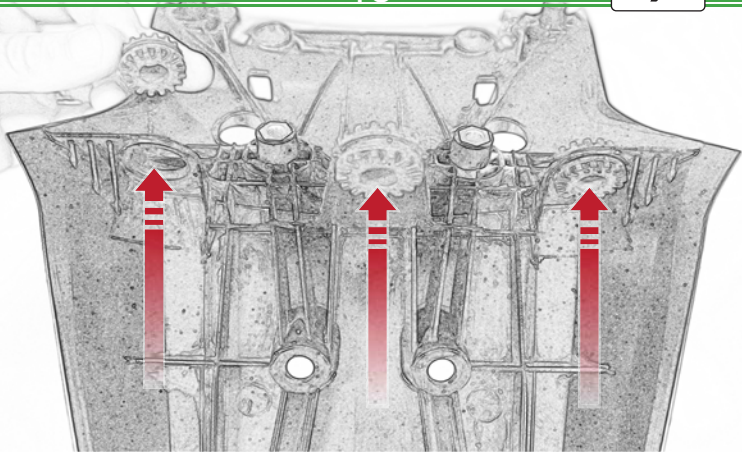

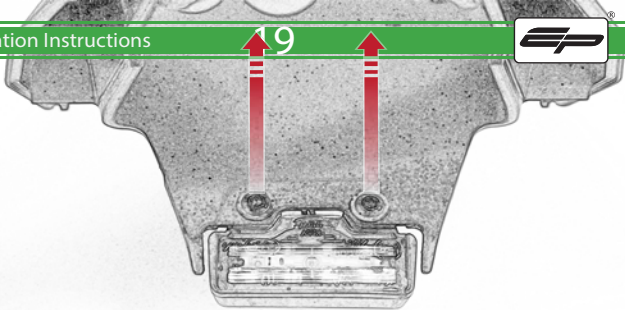



Repeat  
Both Sides

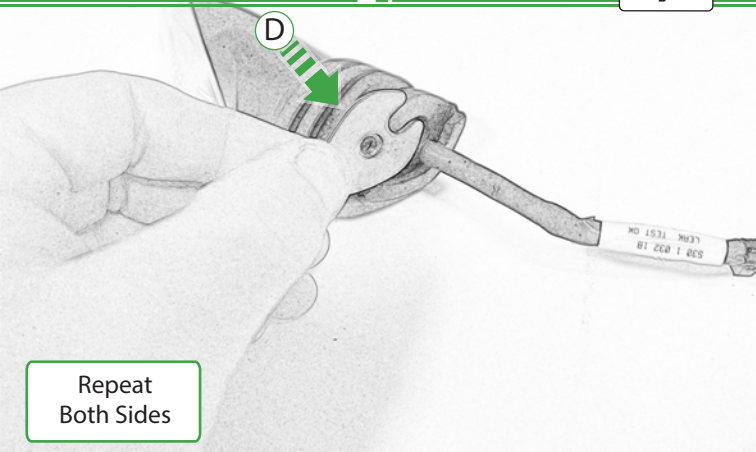

Repeat  
Both Sides

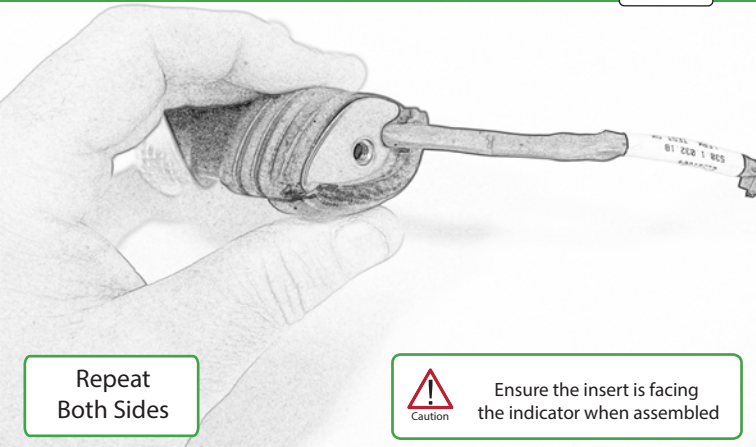

Repeat  
Both Sides



Ensure the insert is facing  
the indicator when assembled

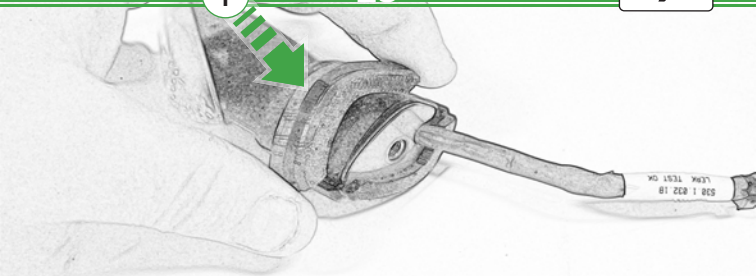

Repeat  
Both Sides



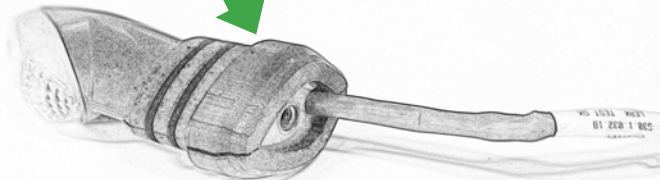

Repeat  
Both Sides

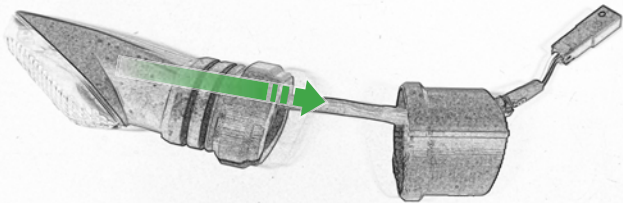

Repeat  
Both Sides



B

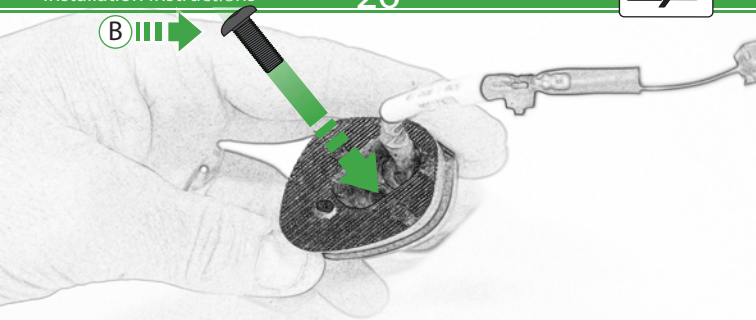

Repeat  
Both Sides

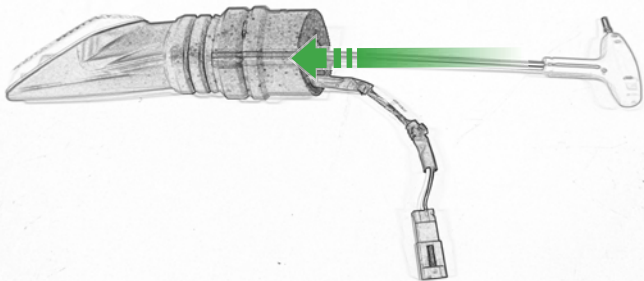

Repeat  
Both Sides

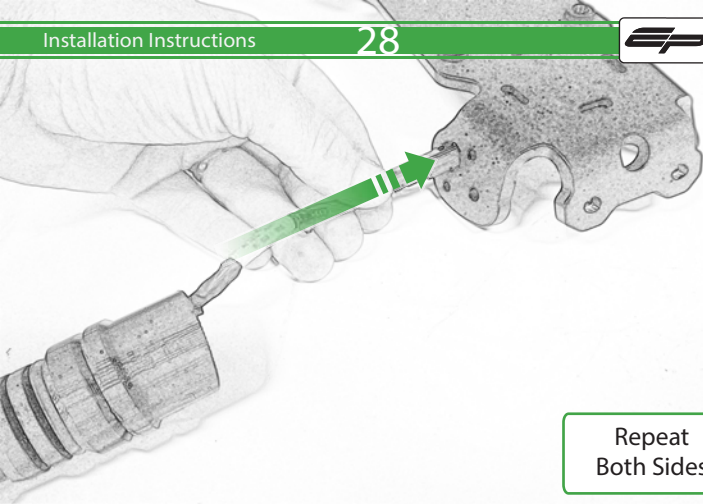

Repeat  
Both Sides

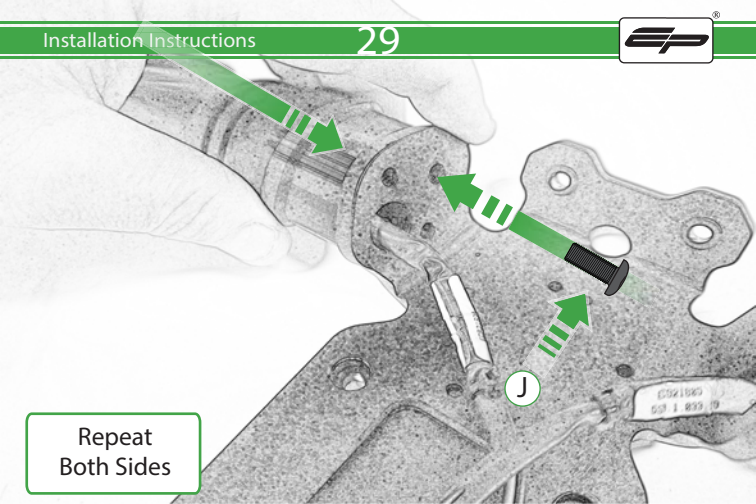

Repeat  
Both Sides

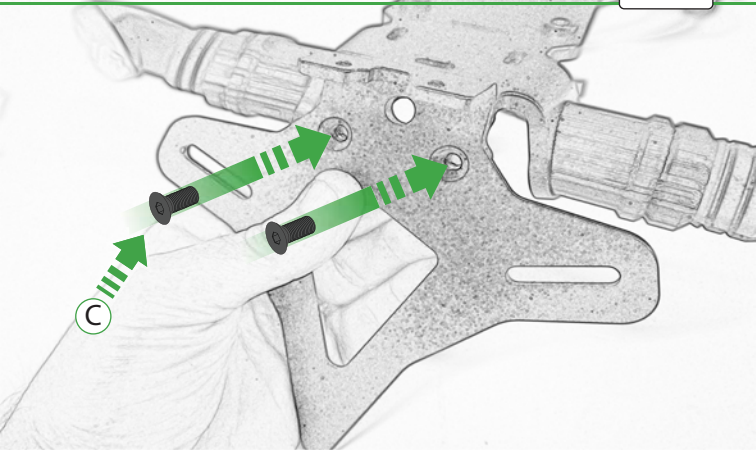

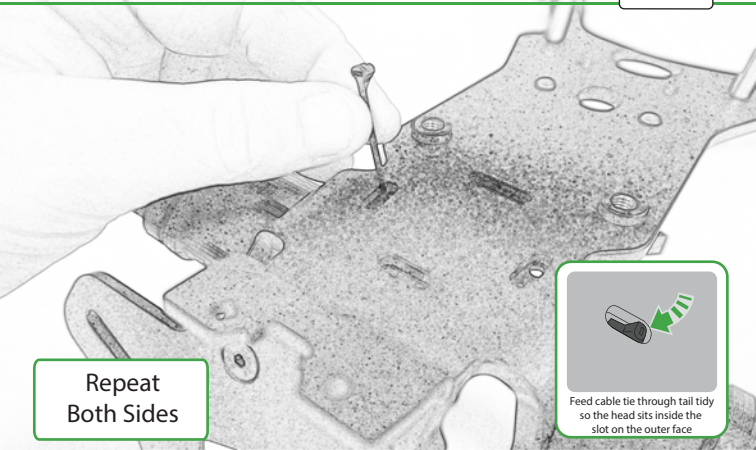

Repeat  
Both Sides



Feed cable tie through tail tidy  
so the head sits inside the  
slot on the outer face





Repeat  
Both Sides



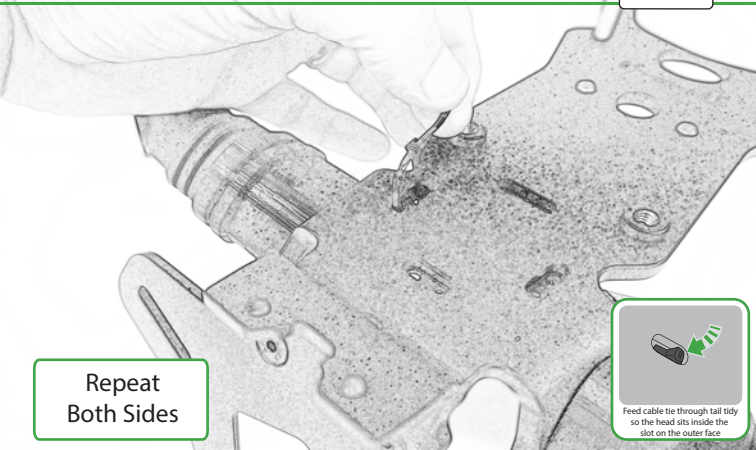

Repeat  
Both Sides



Feed cable tie through tail tidy  
so the head sits inside the  
slot on the outer face



Repeat  
Both Sides

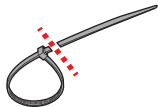



Feed cable tie through tail tidy so the head sits inside the slot on the outer face

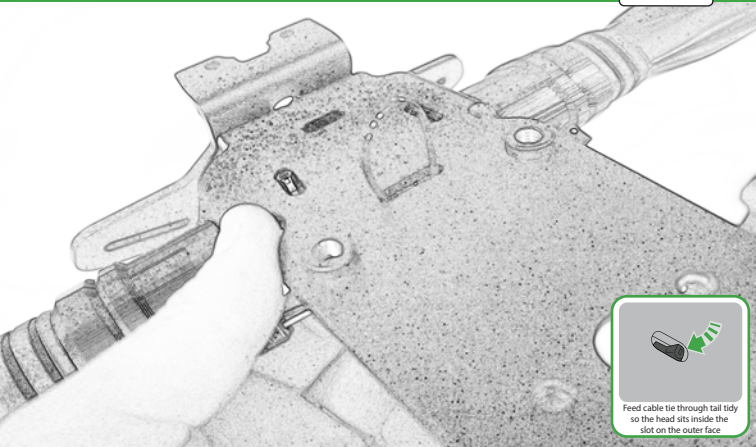

Feed cable tie through tail tidy so the head sits inside the slot on the outer face

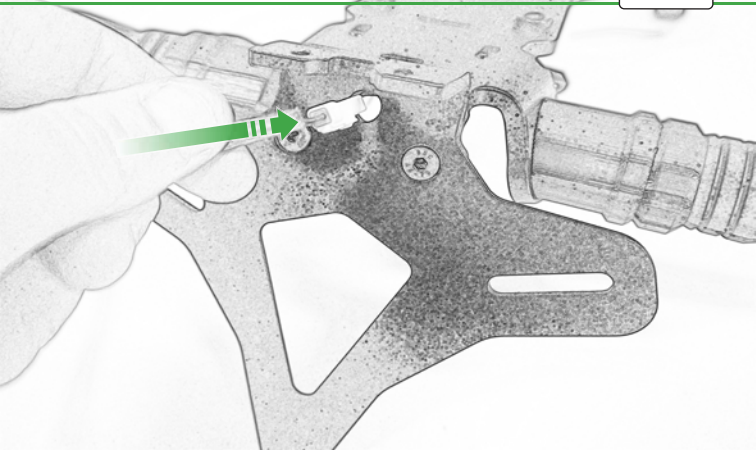

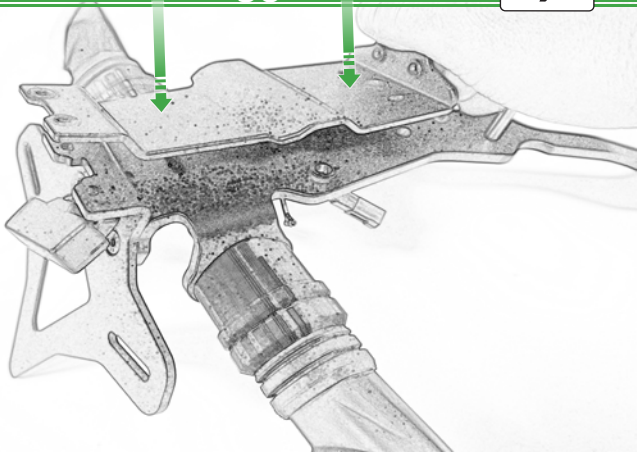

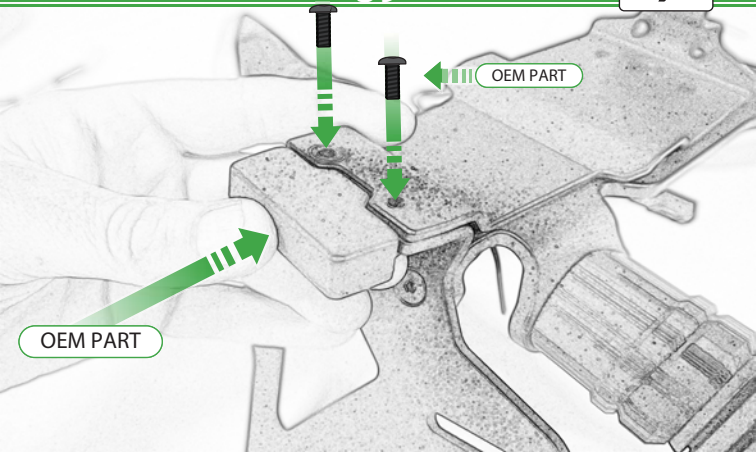

OEM PART

OEM PART



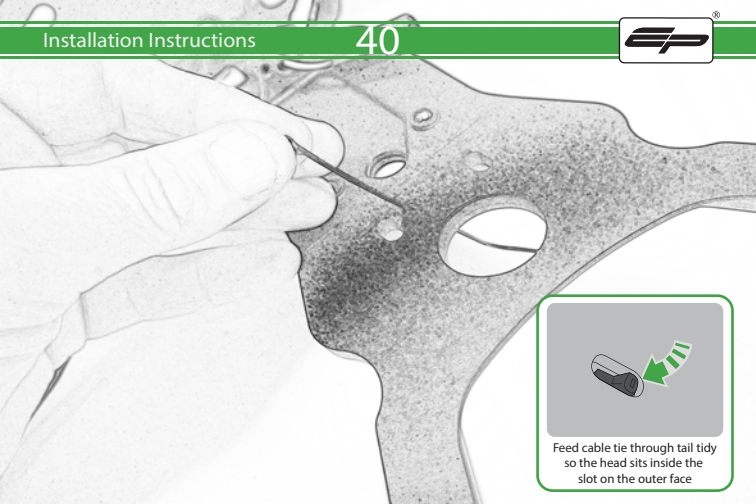

Feed cable tie through tail tidy  
so the head sits inside the  
slot on the outer face

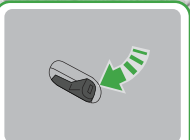
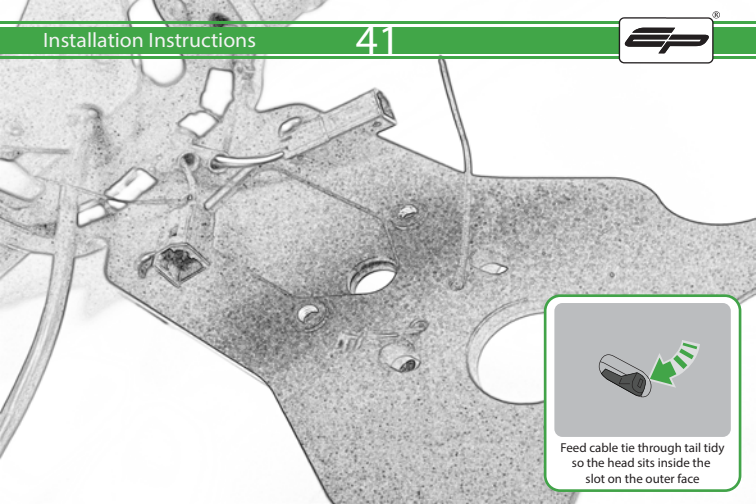

Feed cable tie through tail tidy  
so the head sits inside the  
slot on the outer face

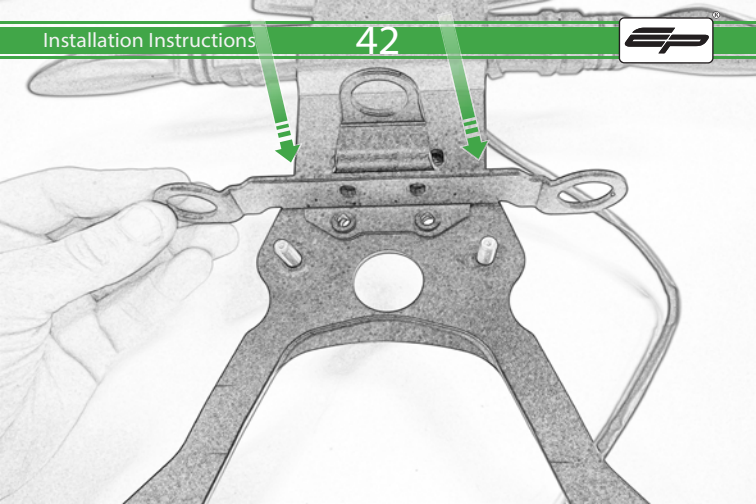

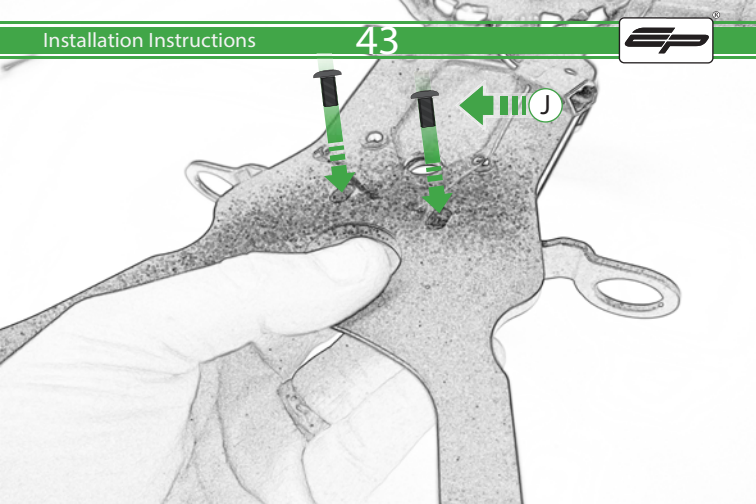

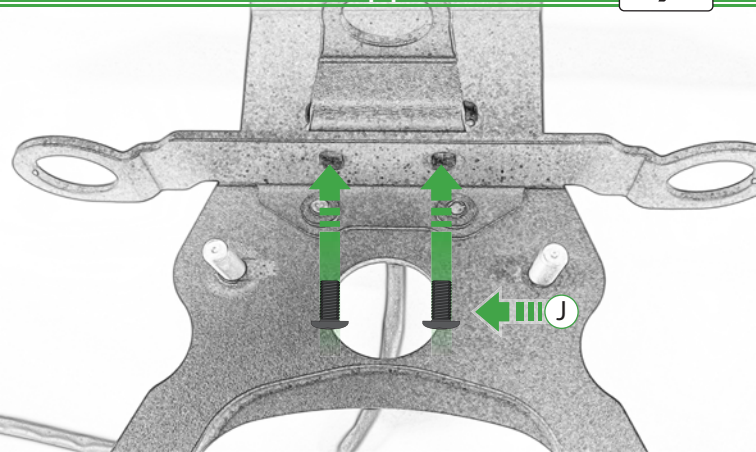

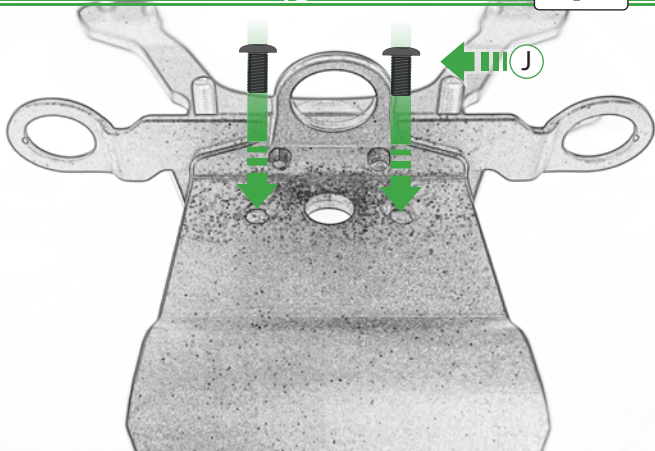

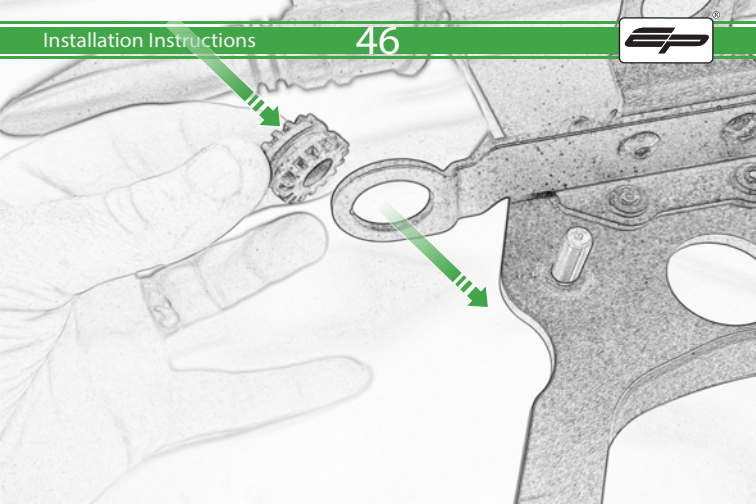

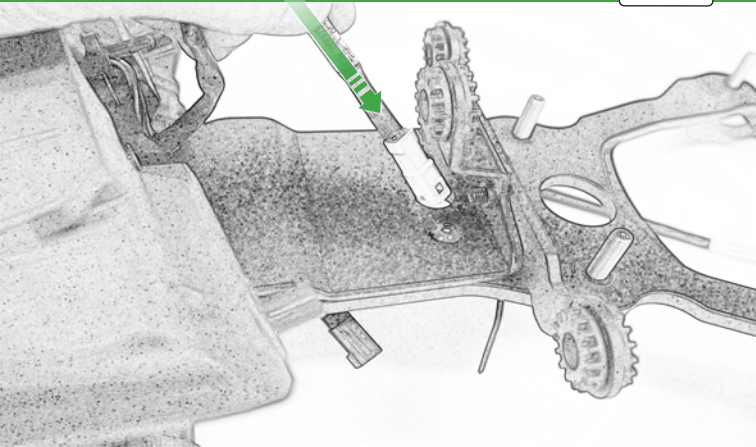



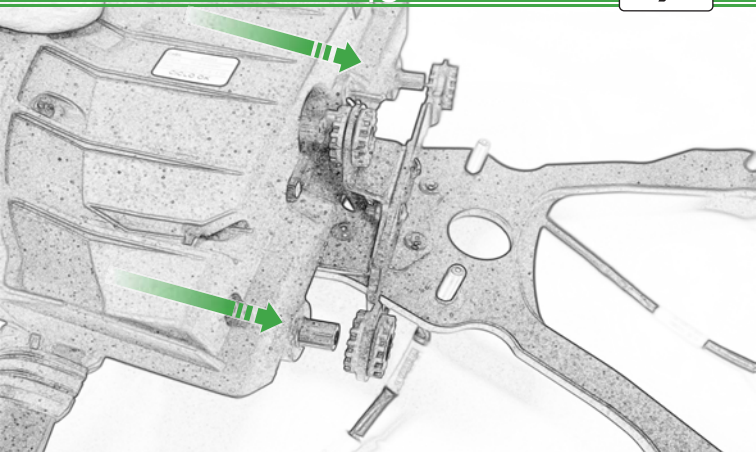

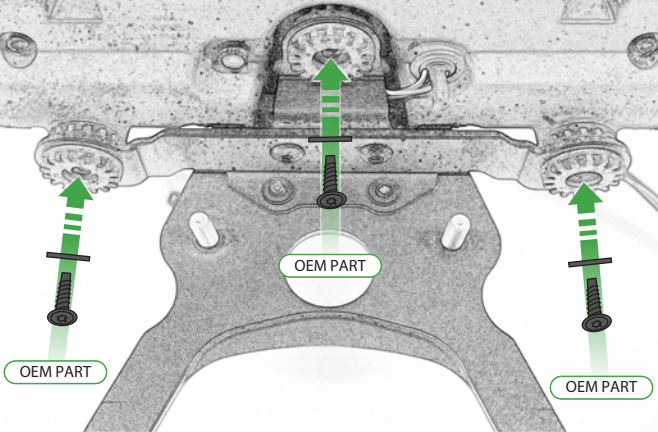

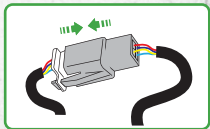
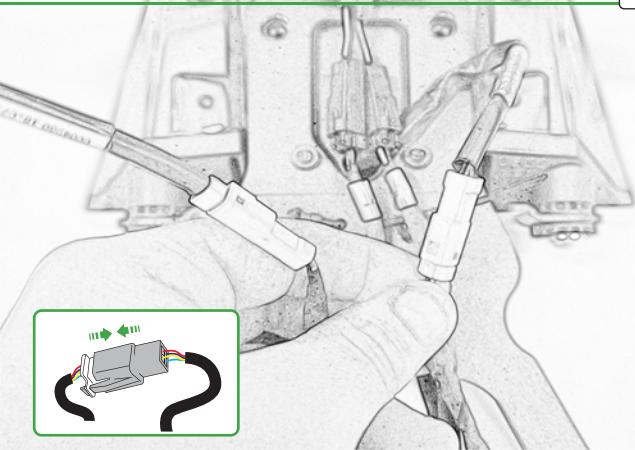



Feed cable tie through tail tidy  
so the head sits inside the  
slot on the outer face

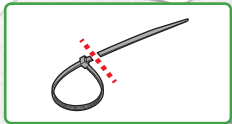
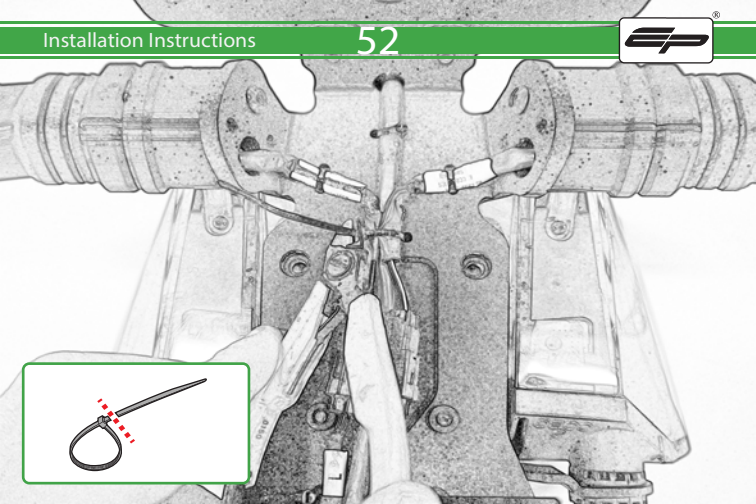

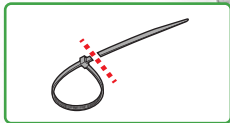
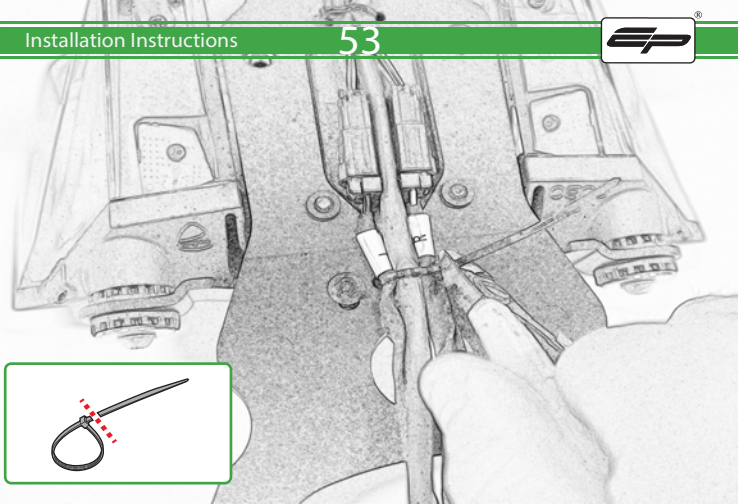

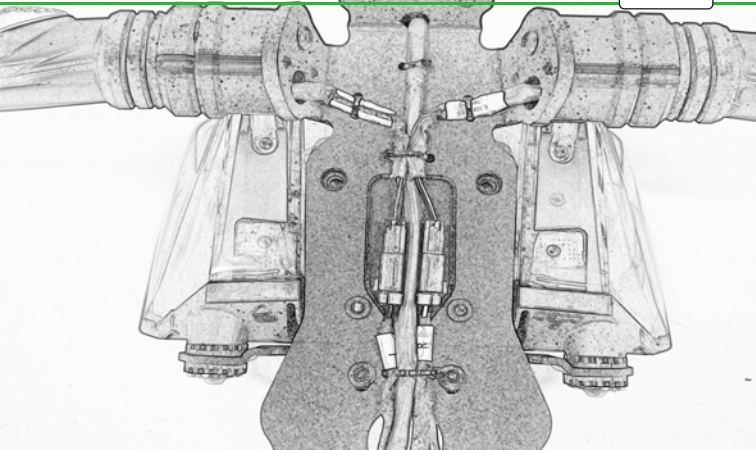

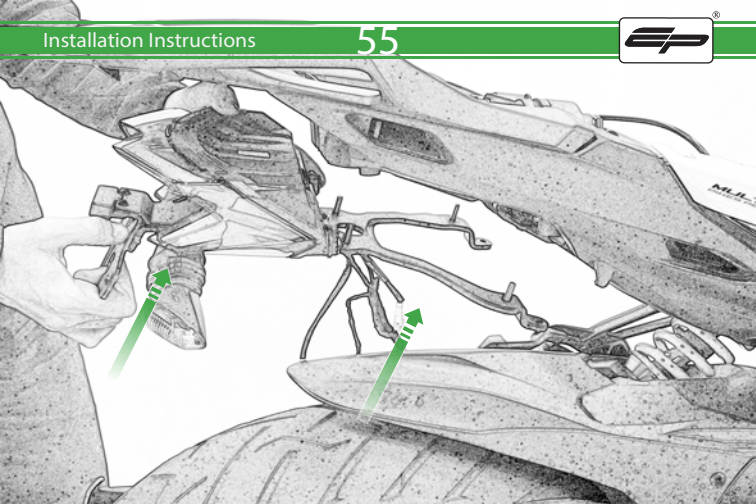



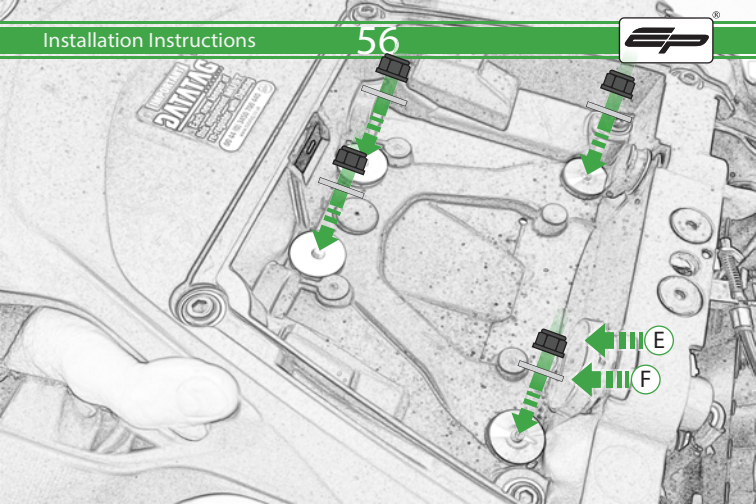

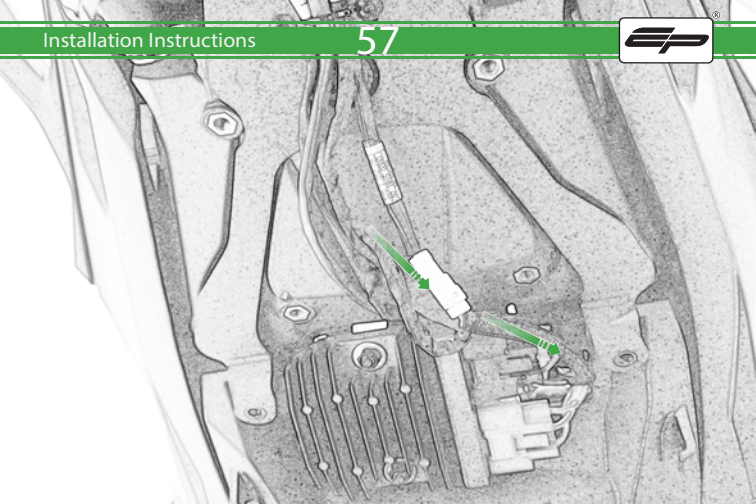

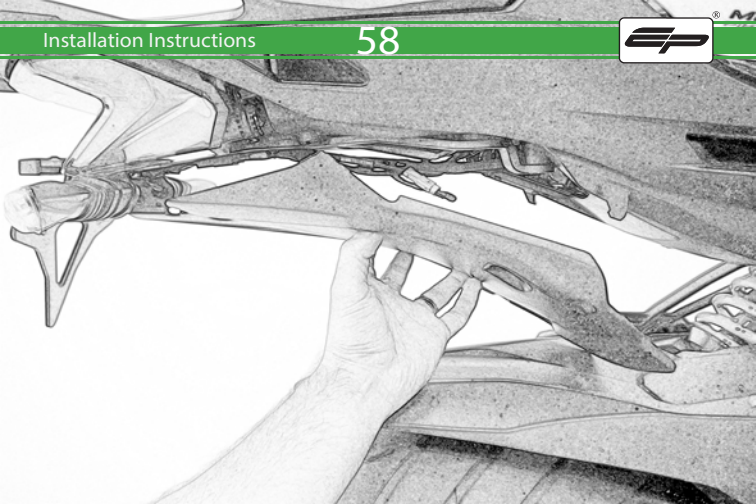



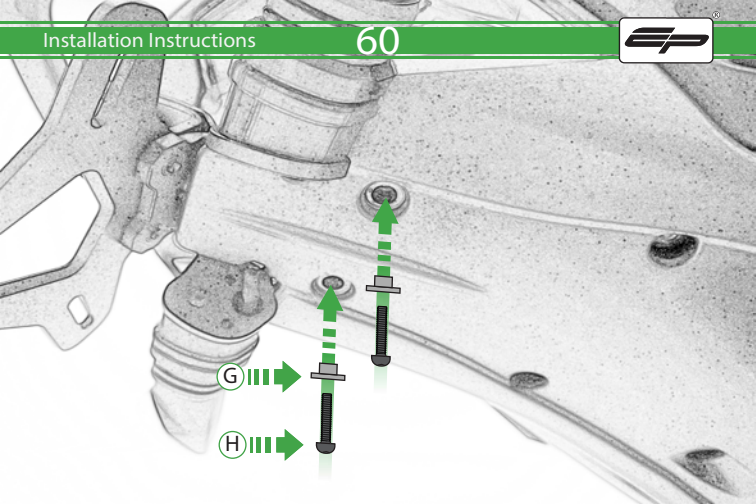

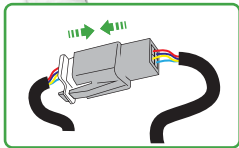
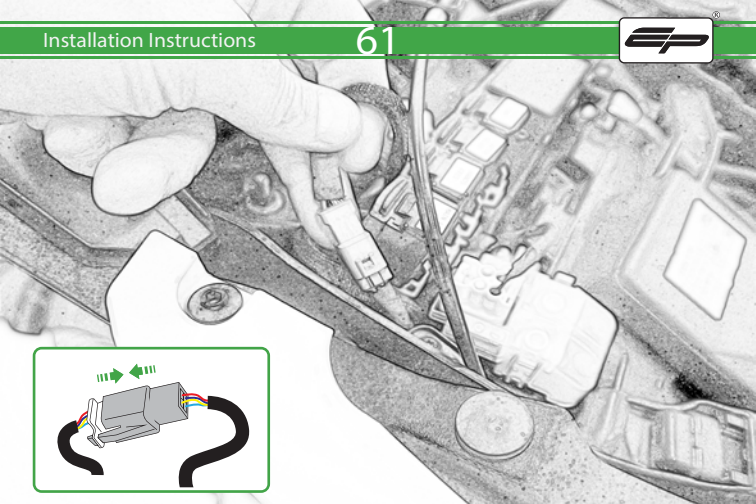

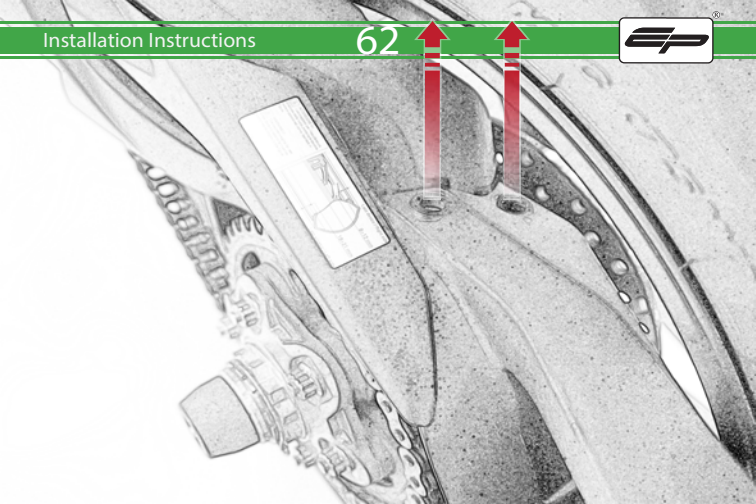
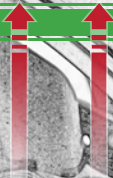

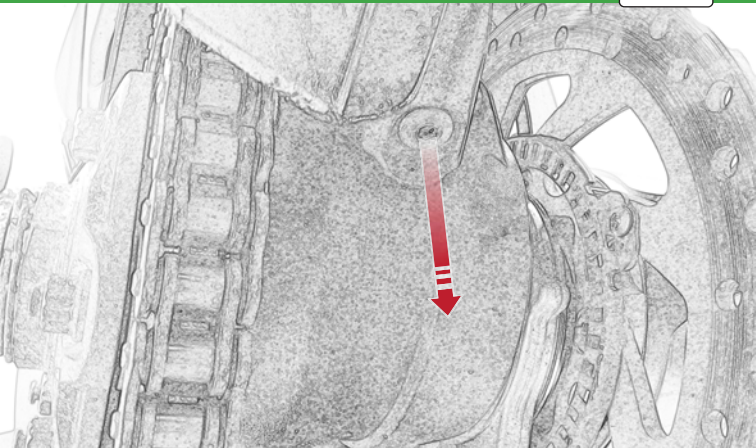



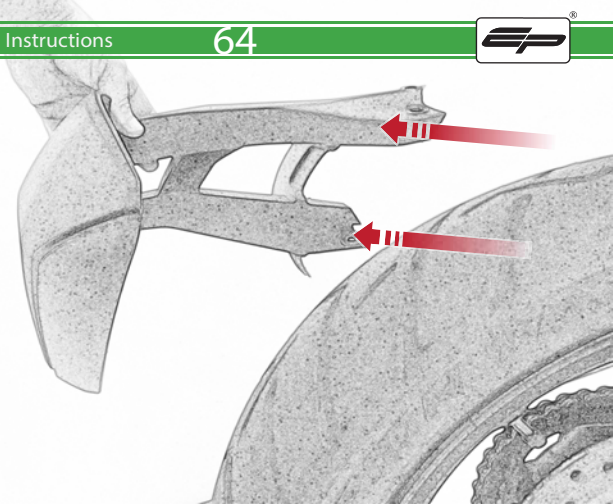





 **ESSENTIAL CHECKS** 

After installation of your tail tidy ensure that the licence plate does not contact the rear tyre when suspension is fully compressed.

Ensure all electrics including indicators, tail light, brake light and licence plate light lights are working correctly before riding the motorcycle.

It is recommended that periodic inspections are made to ensure that all fixings are fully tightend.

