

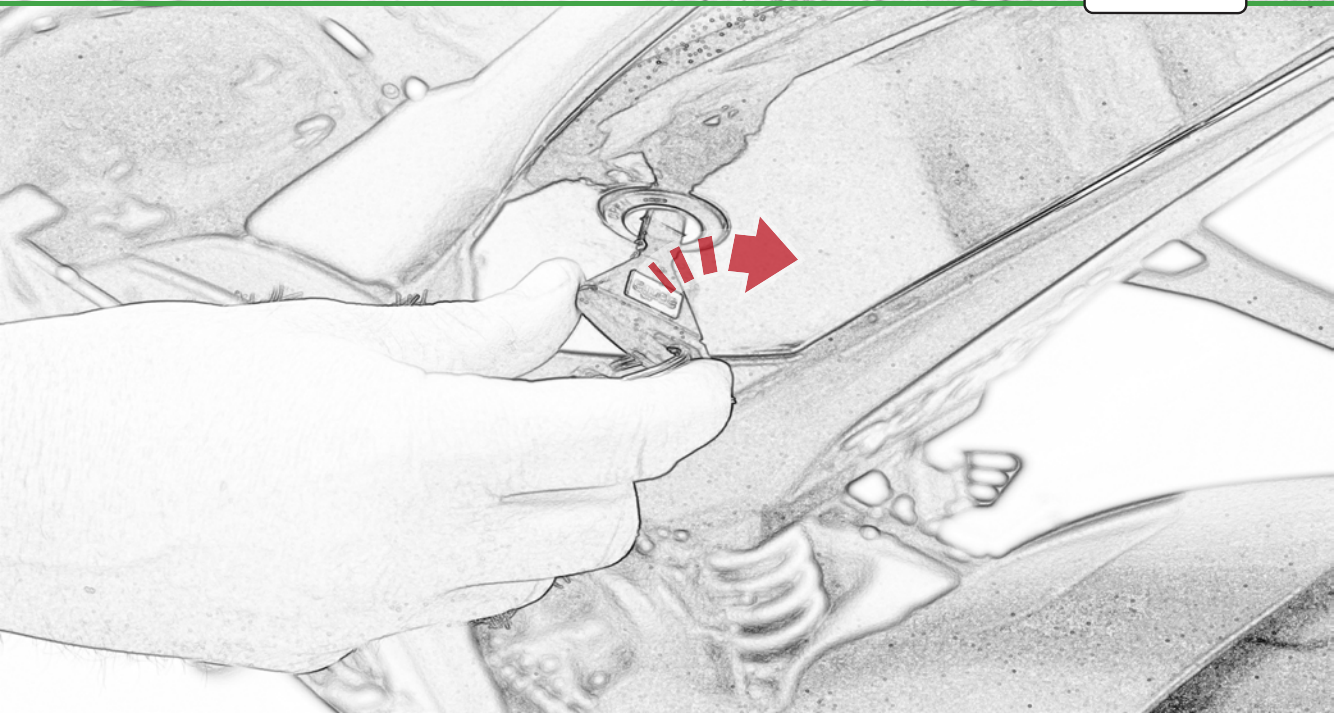

Kit Contents PRN015516

- Ⓐ 1 x Retro Light
- Ⓑ 1 x Spacer
- Ⓒ 1 x Con 10
- Ⓓ 2 x M6 x 12mm Black Button Head Bolts
- Ⓔ 2 x M6 x 25mm Black Button Head Bolts
- Ⓕ 2 x M6 Flange Nut
- Ⓖ 2 x M6 x 16mm Black Button Head Bolts
- Ⓗ 2 x Special Washer
- Ⓘ 2 x M4 Flange Nut
- Ⓝ 2 x M4 x 8mm Black Button Head Bolts
- Ⓚ 2 x M6 x 60mm Black Button Head Bolts (Double Indicator Spacers)
- Ⓛ 3 x M6 x 40mm Black Button Head Bolts (Single Indicator Spacers)

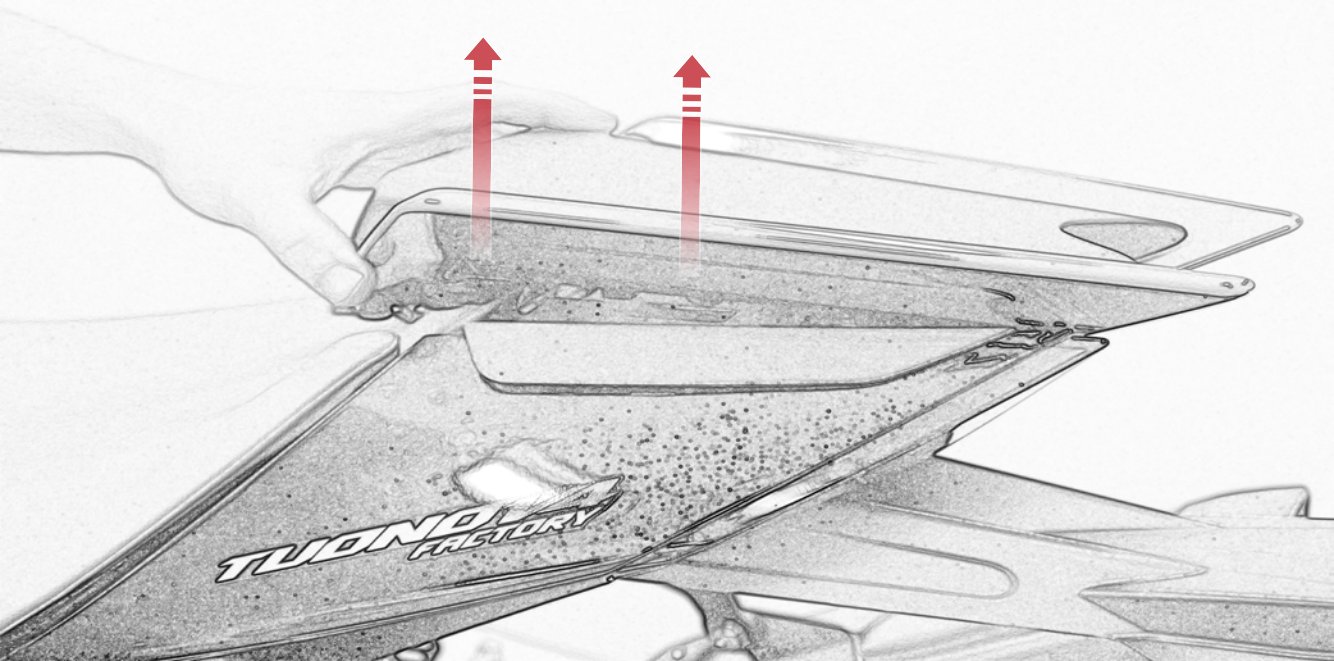





NOVA
FACTORY

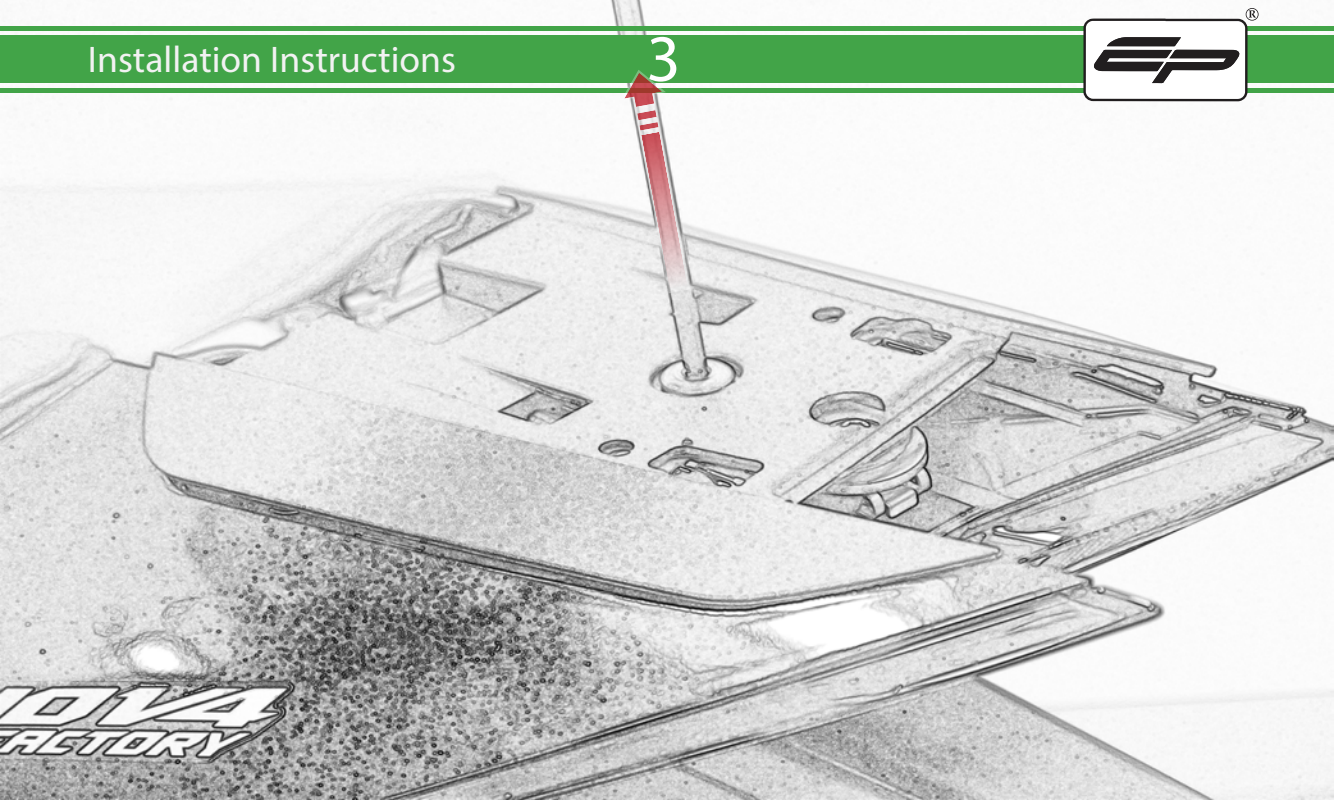

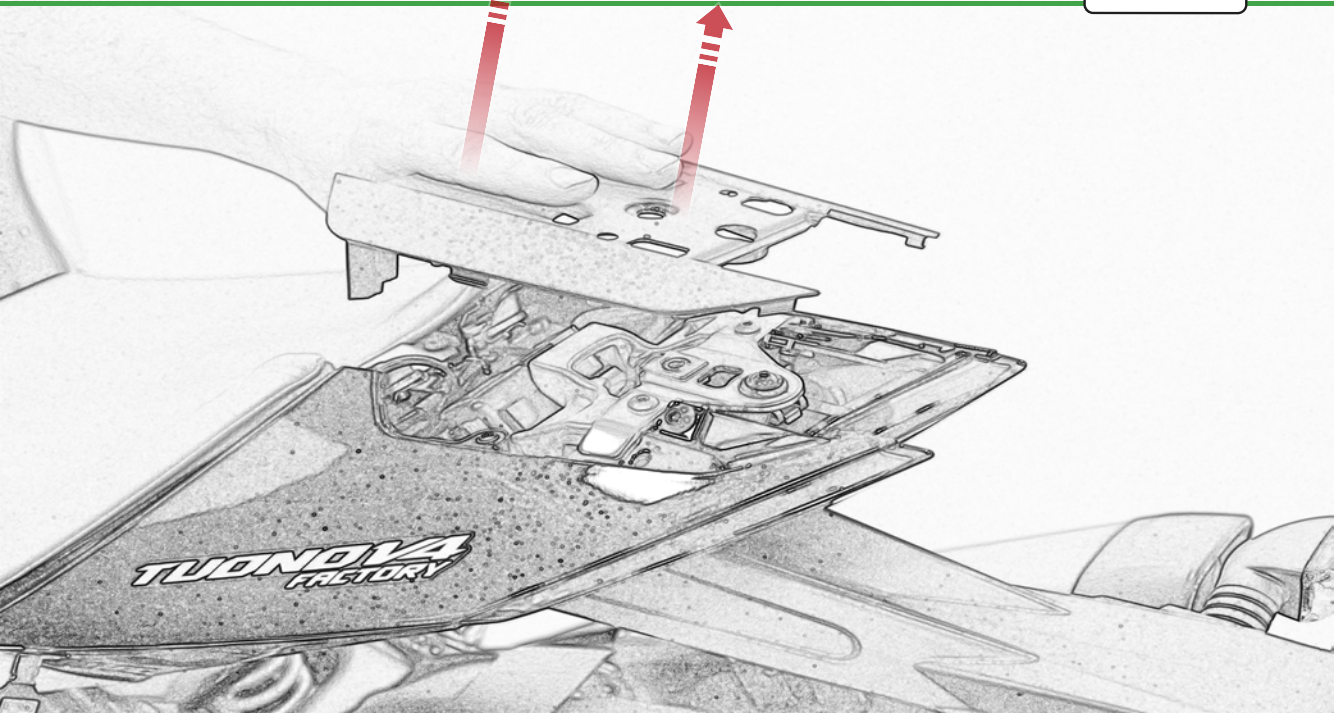

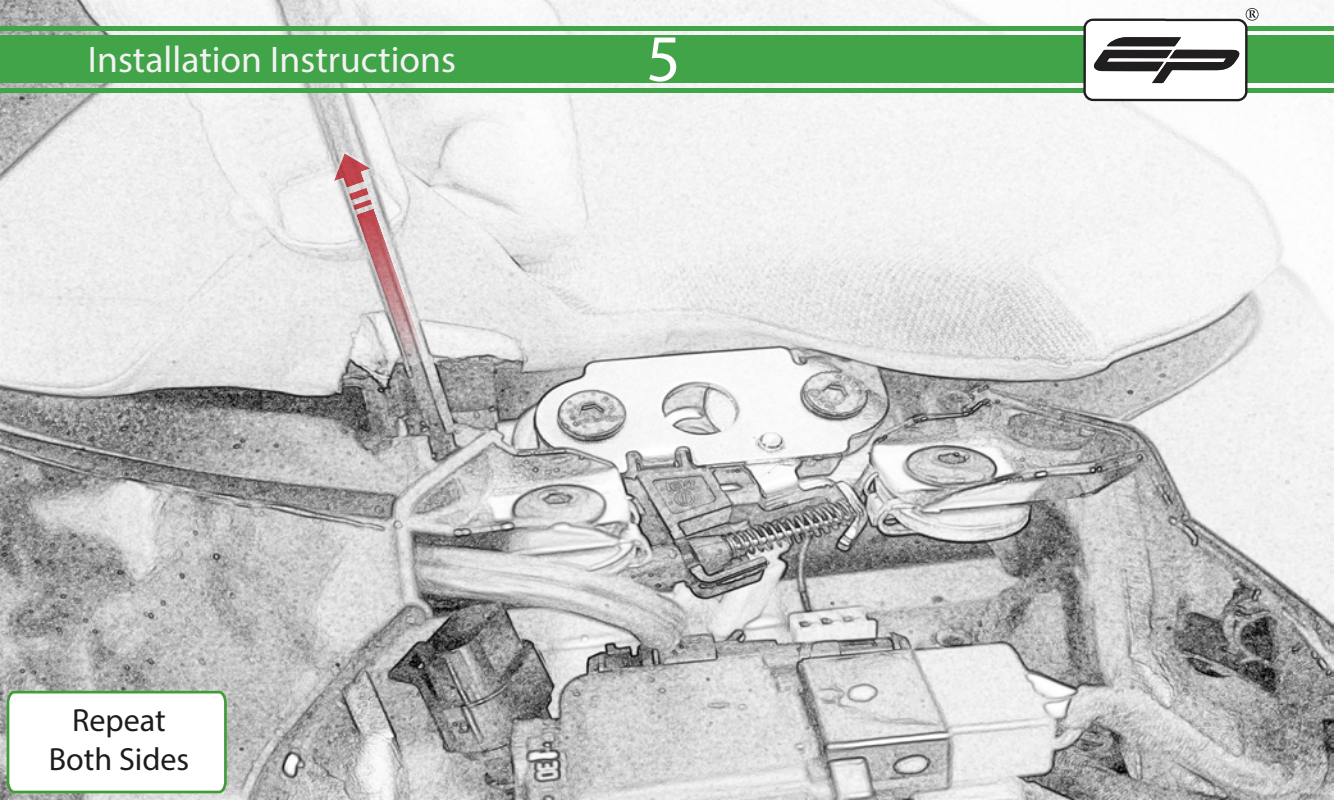

Repeat
Both Sides

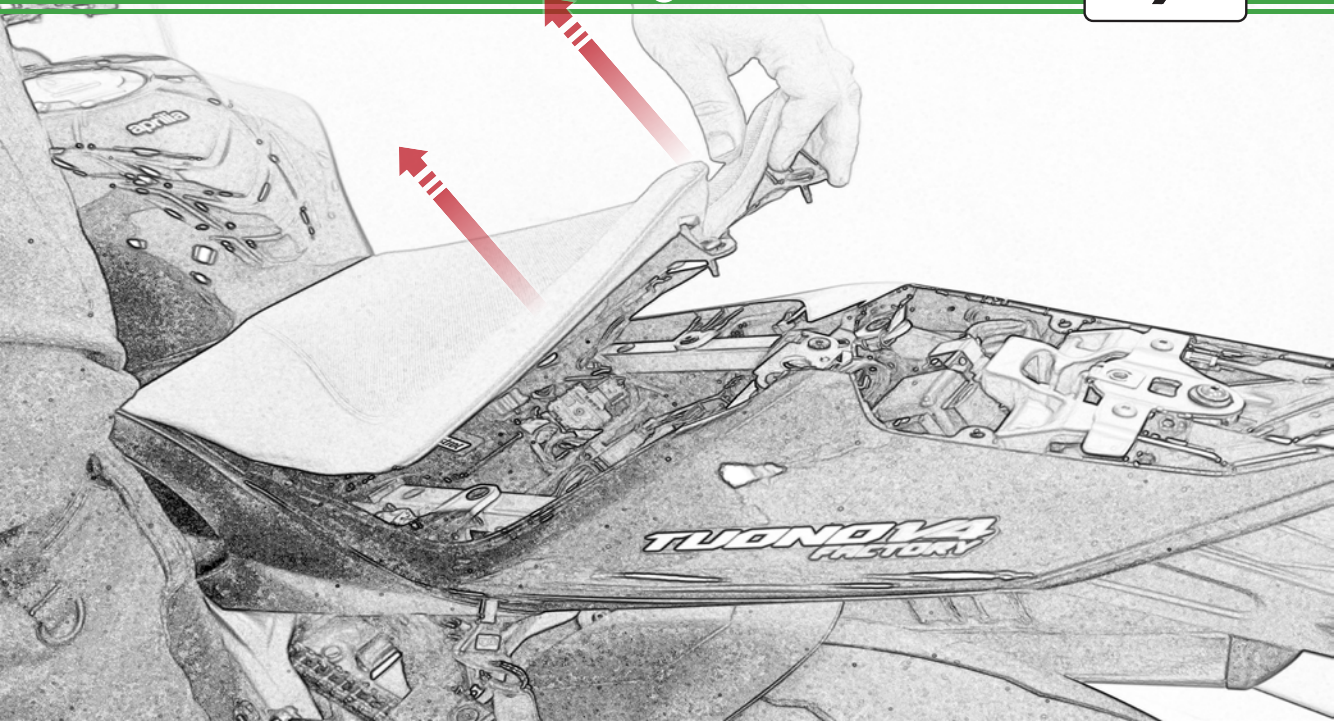

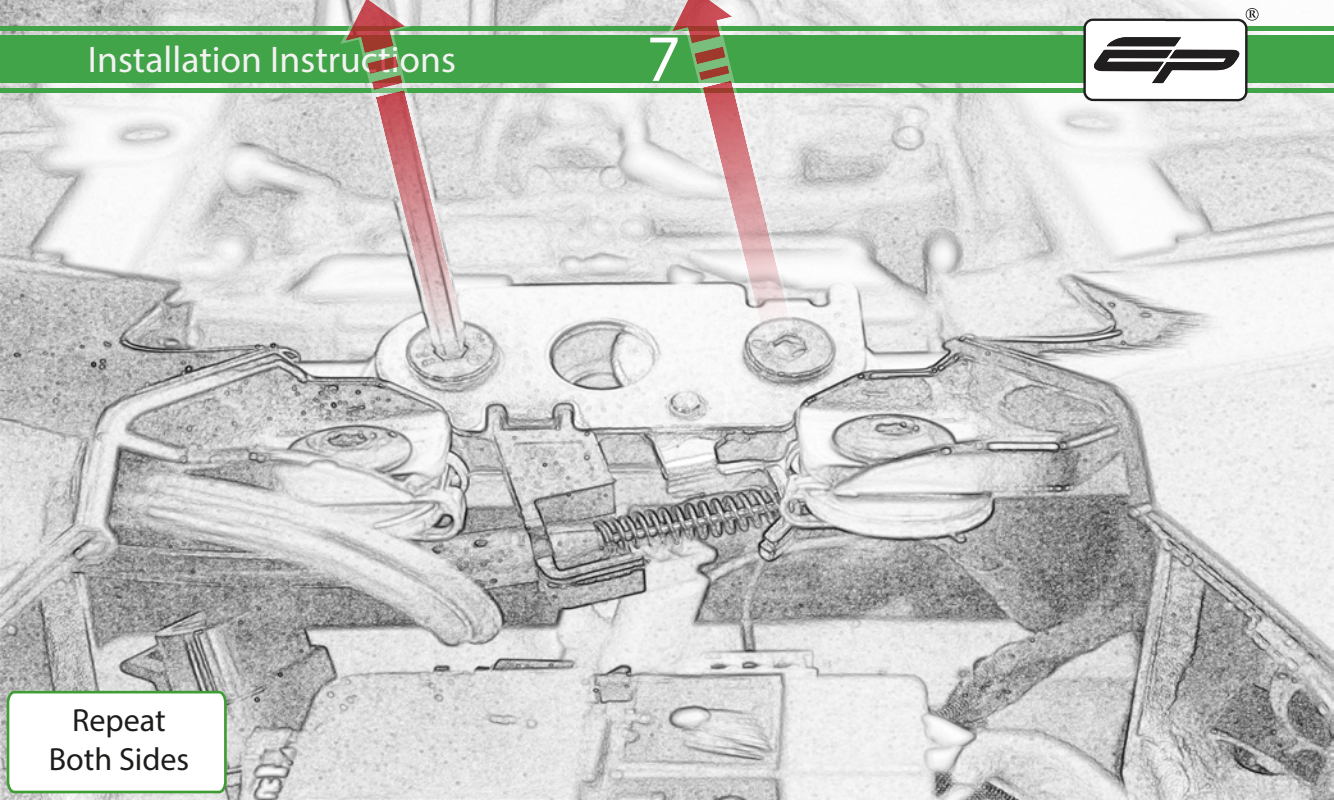

Repeat
Both Sides

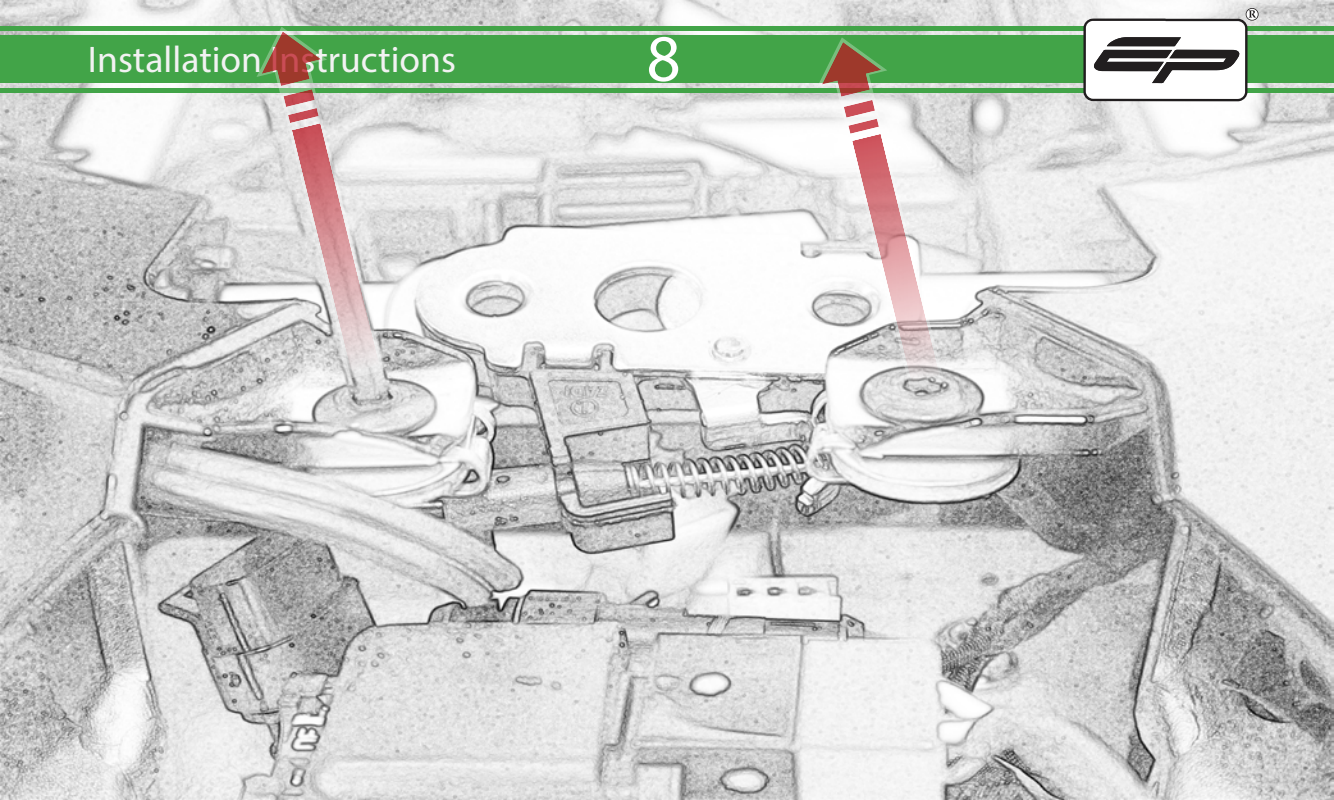

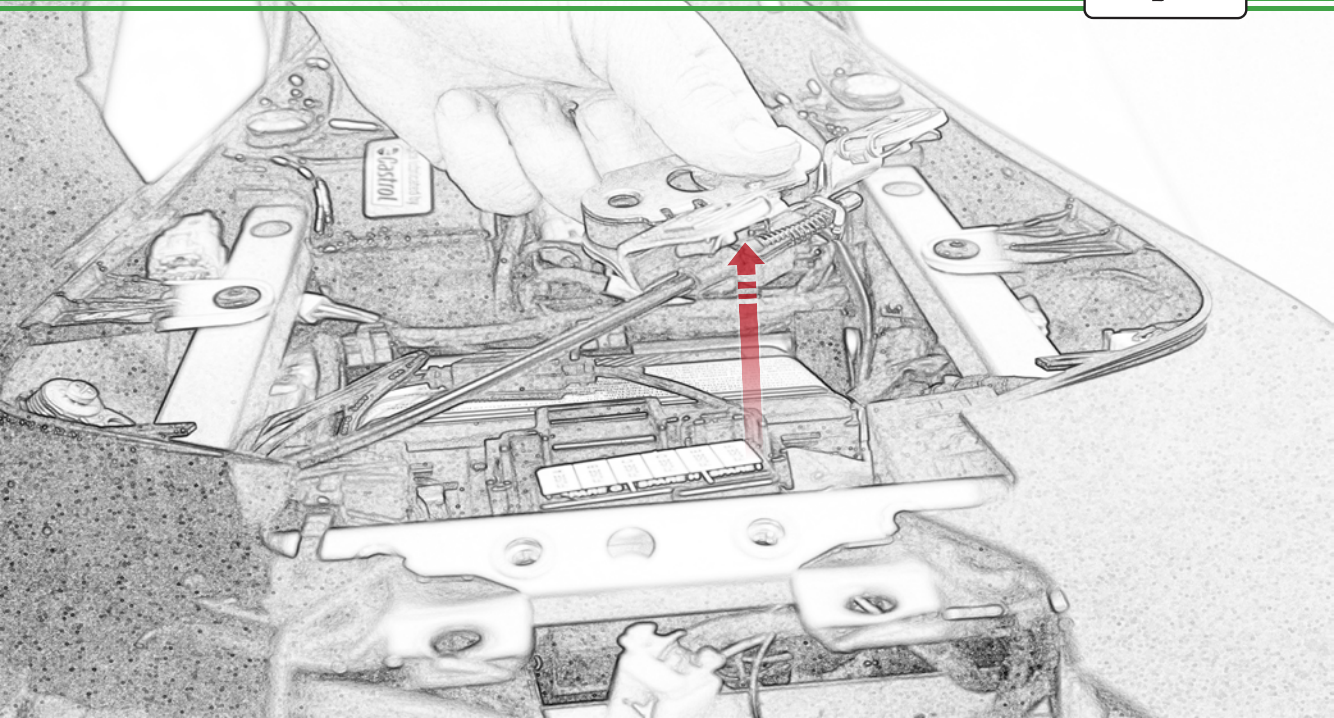

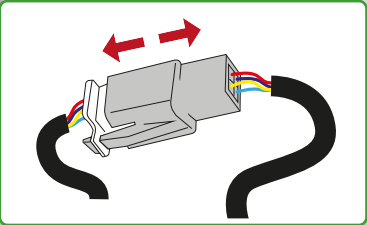
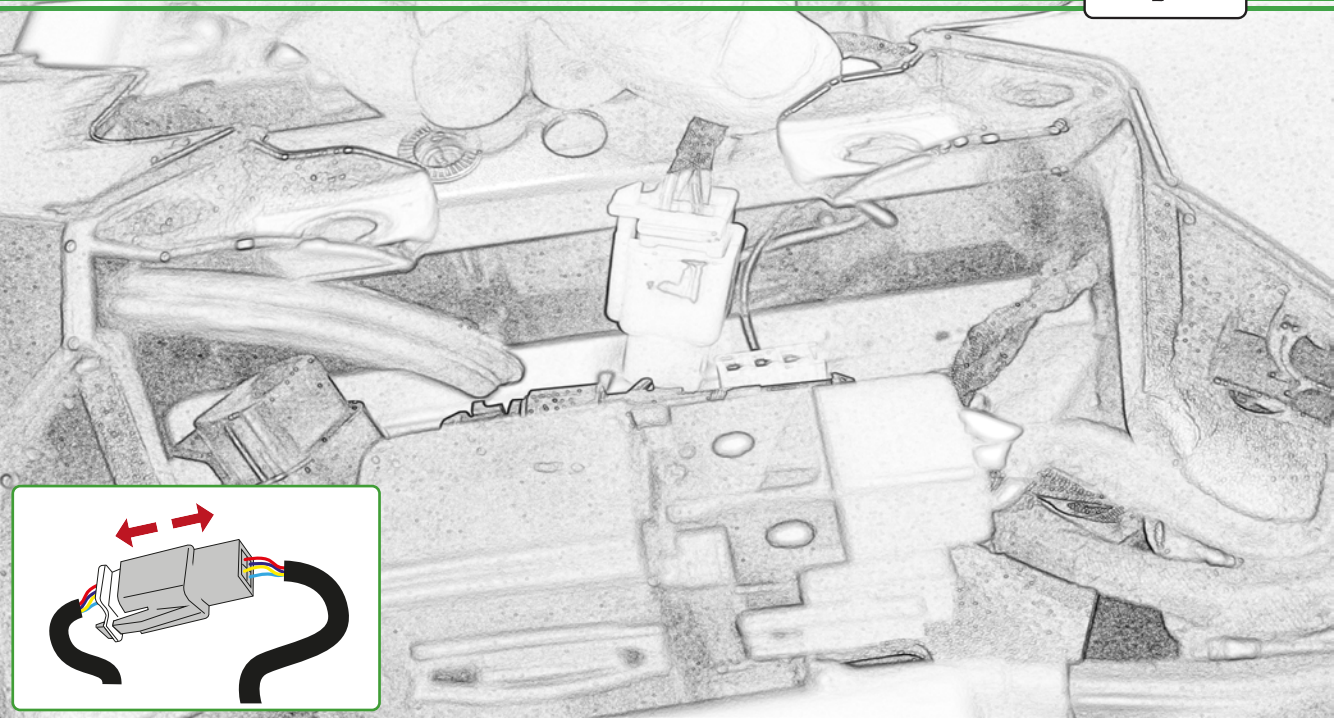

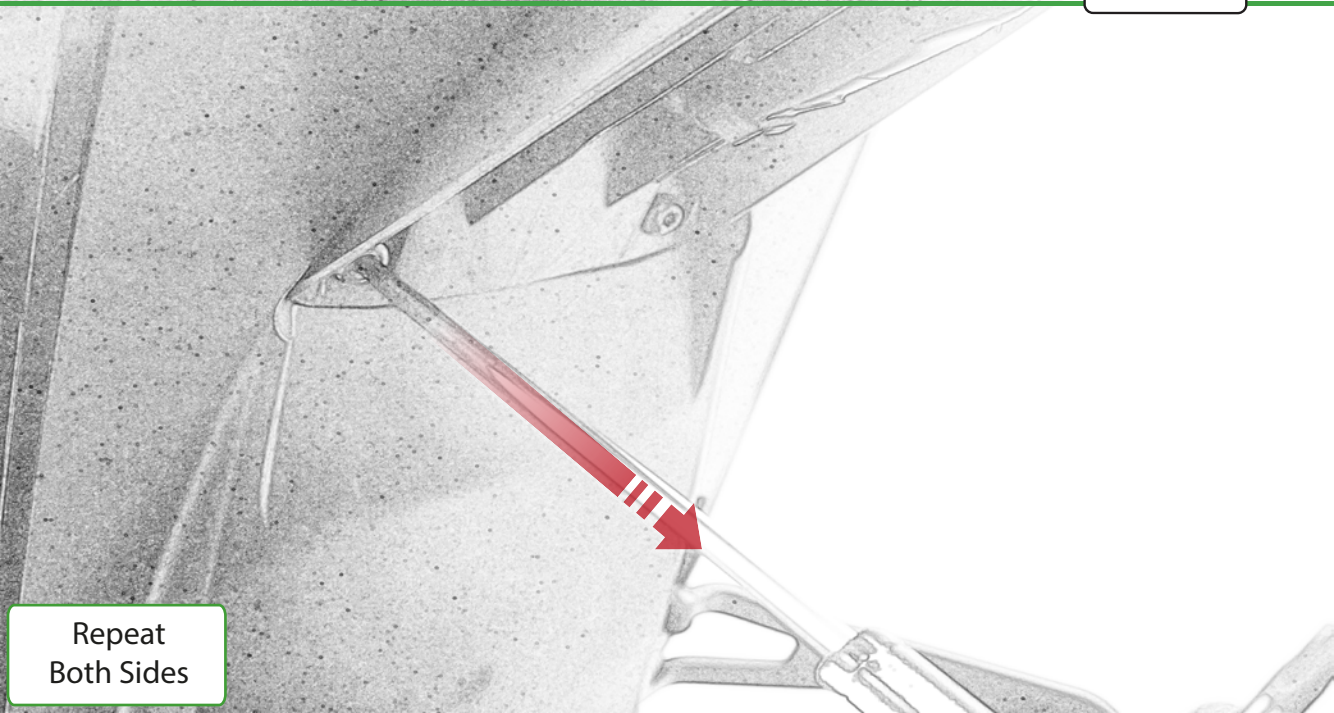

Repeat
Both Sides

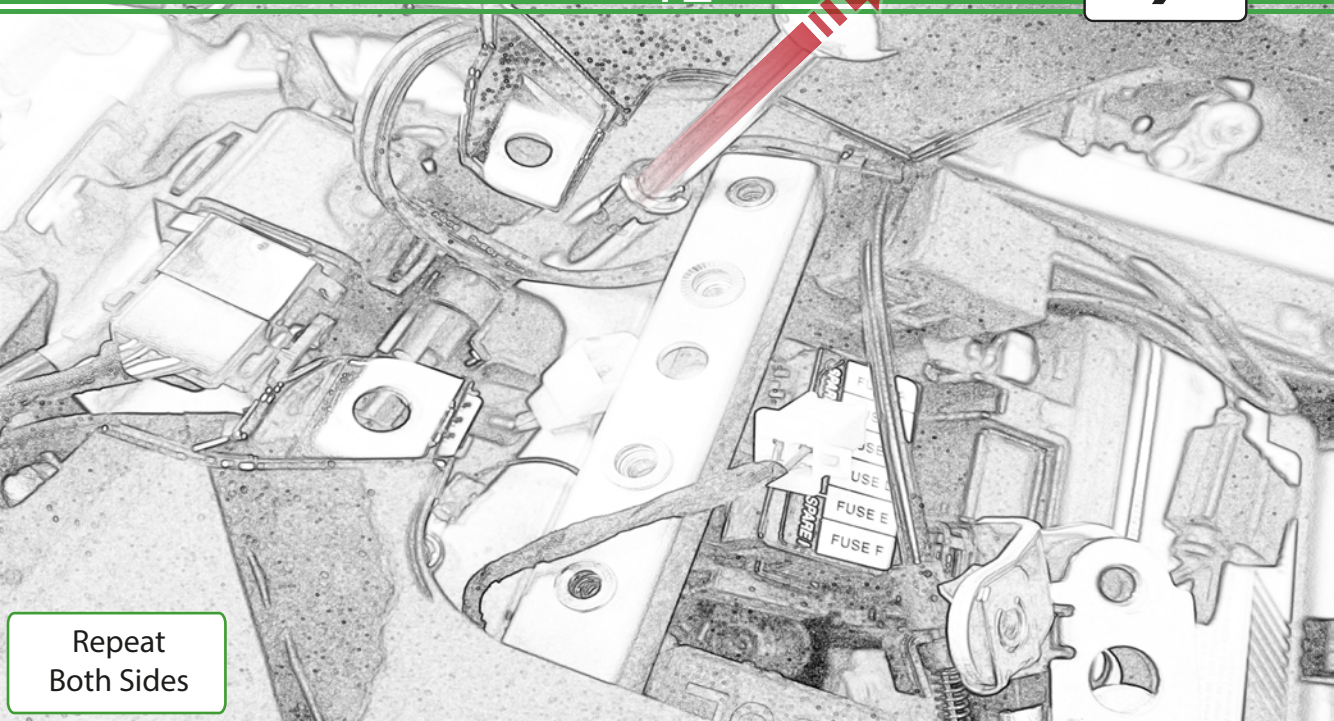

Repeat
Both Sides

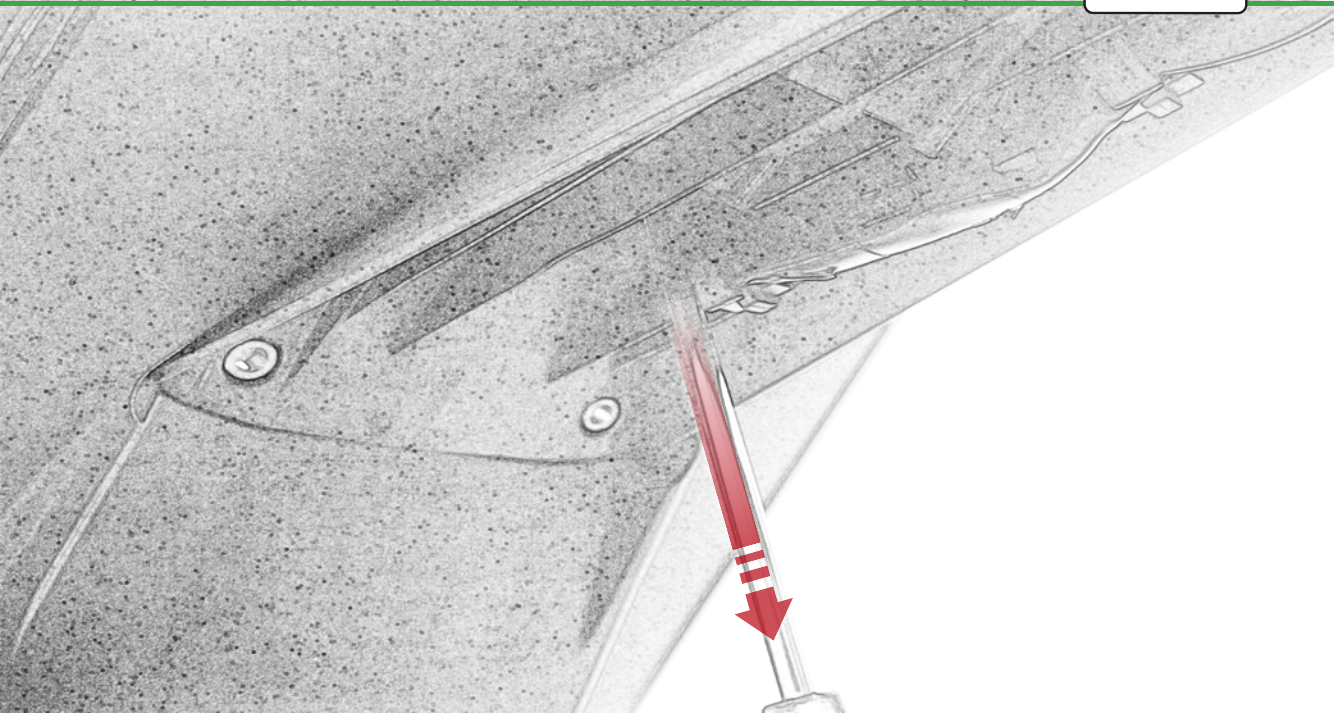

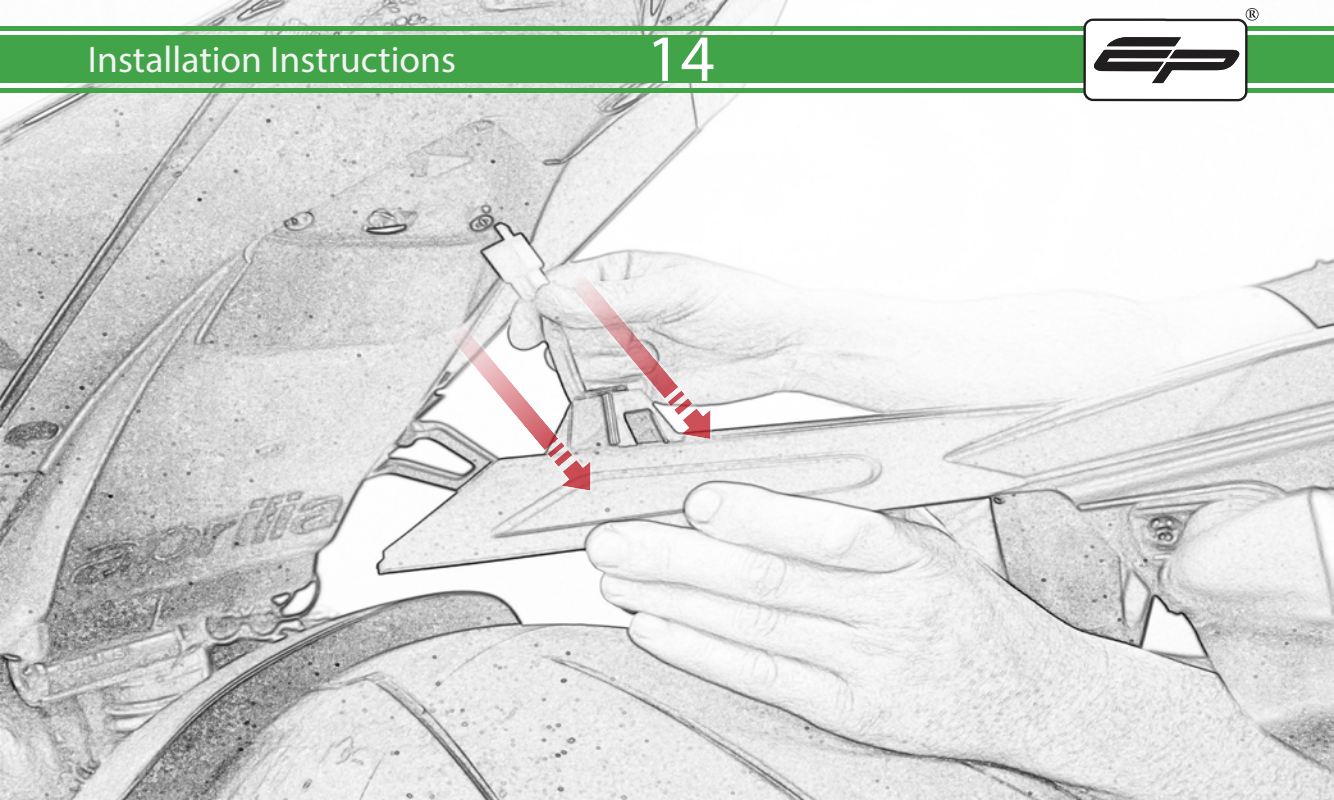

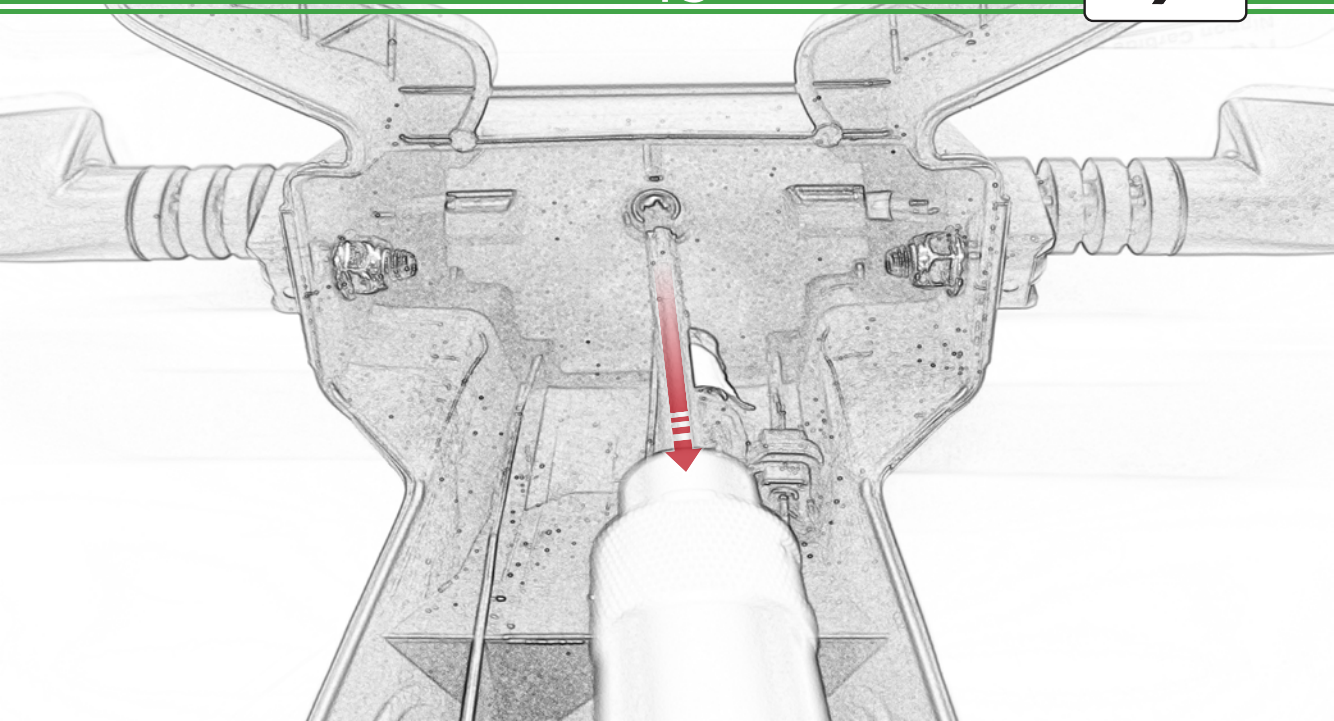

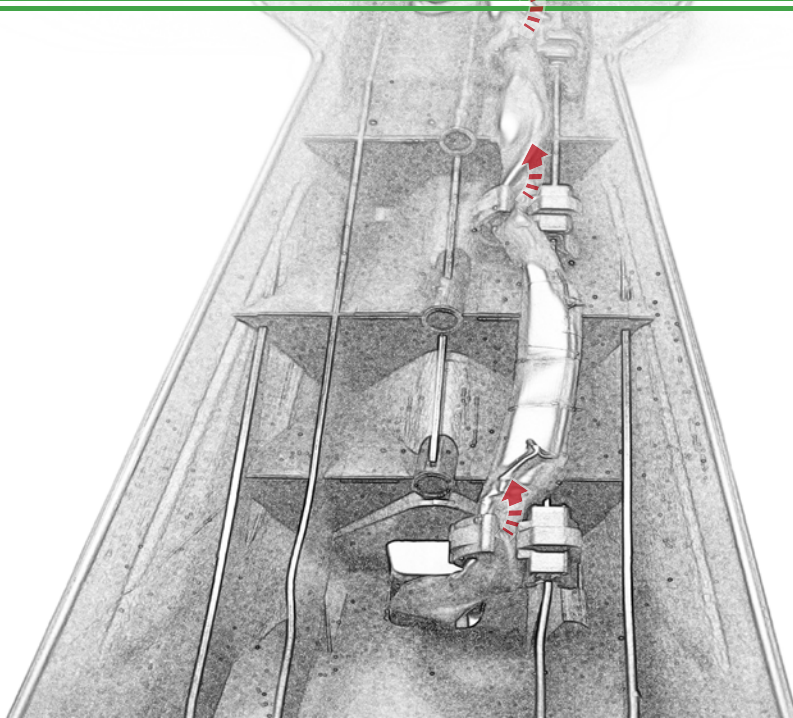

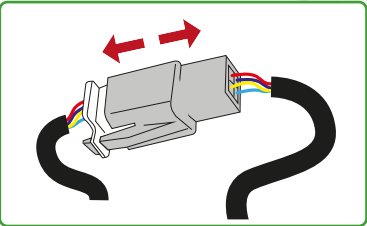
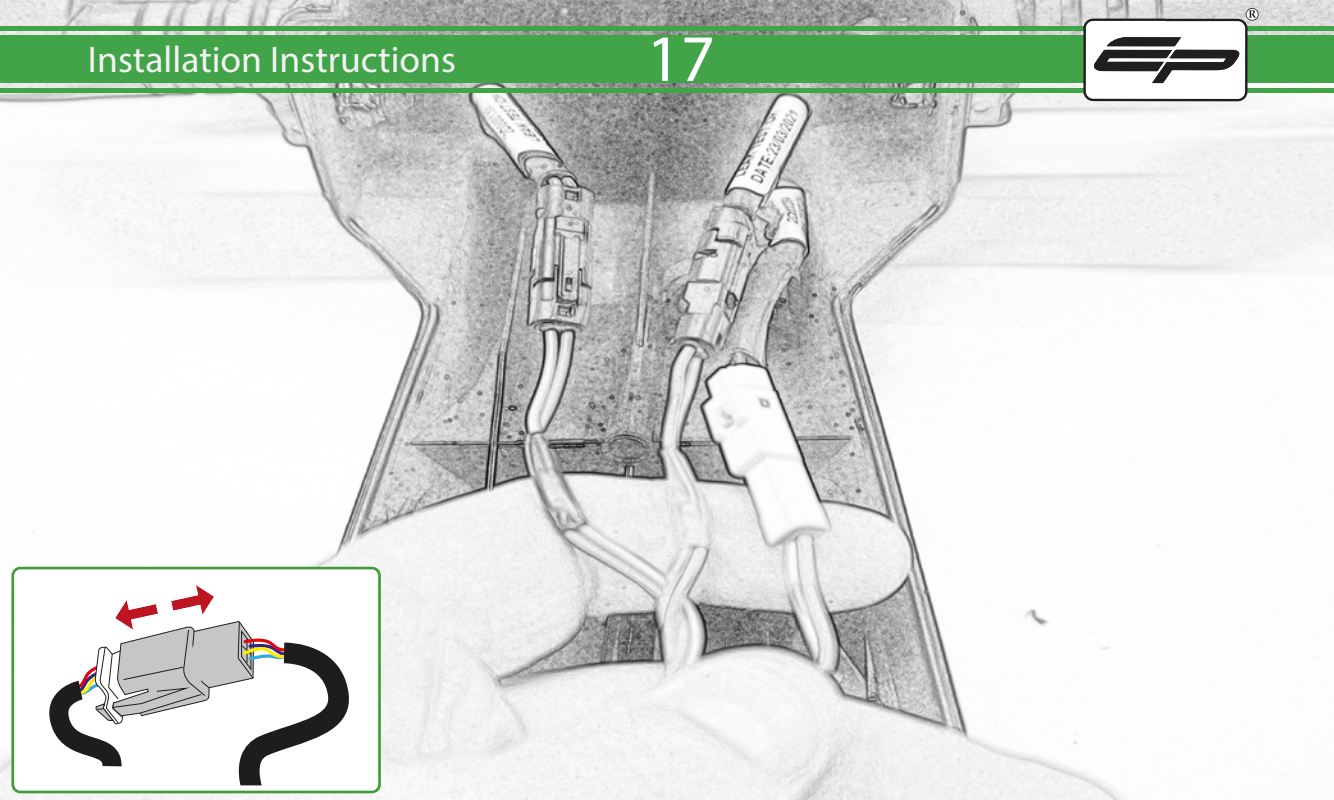

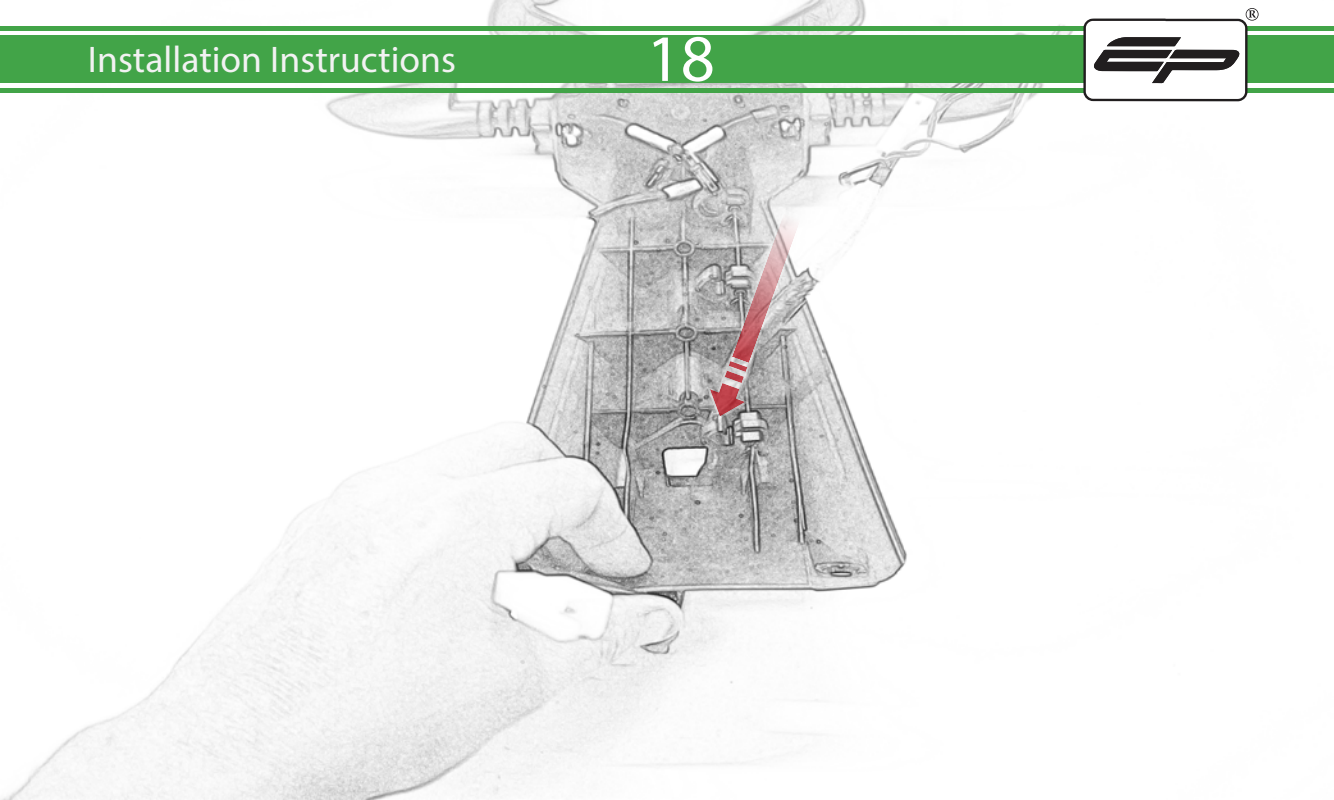

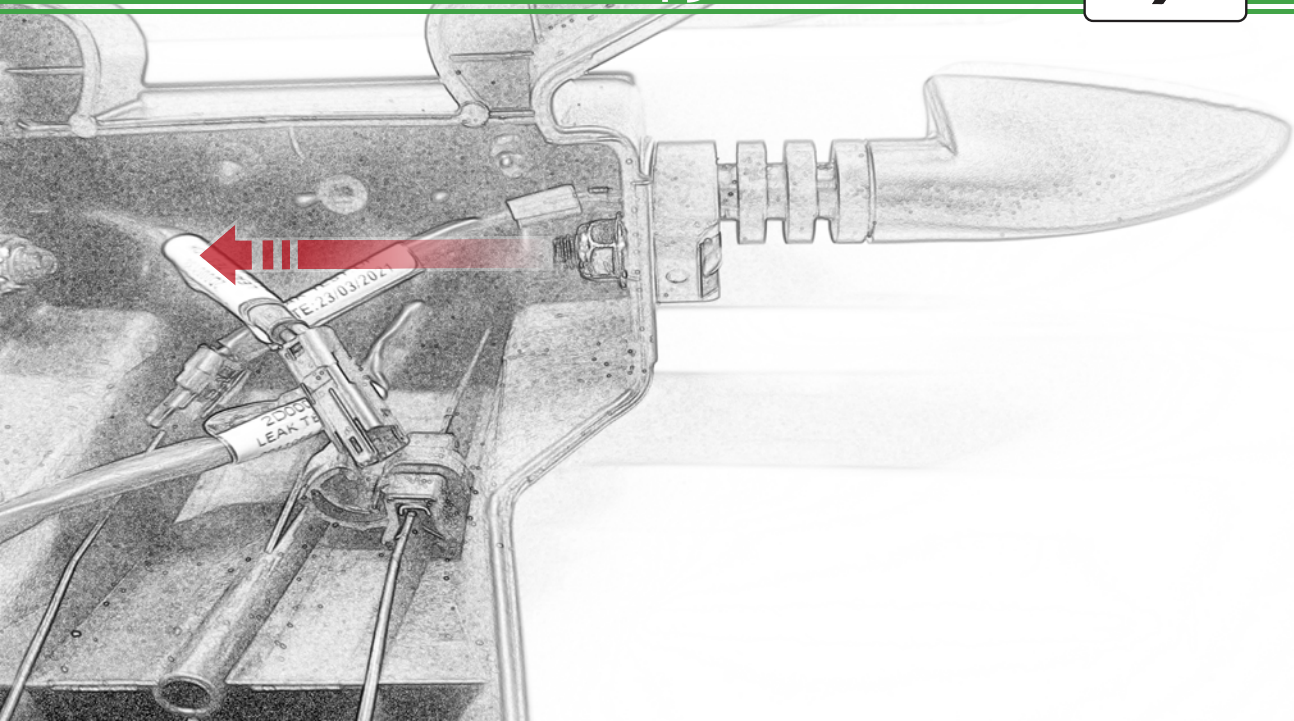

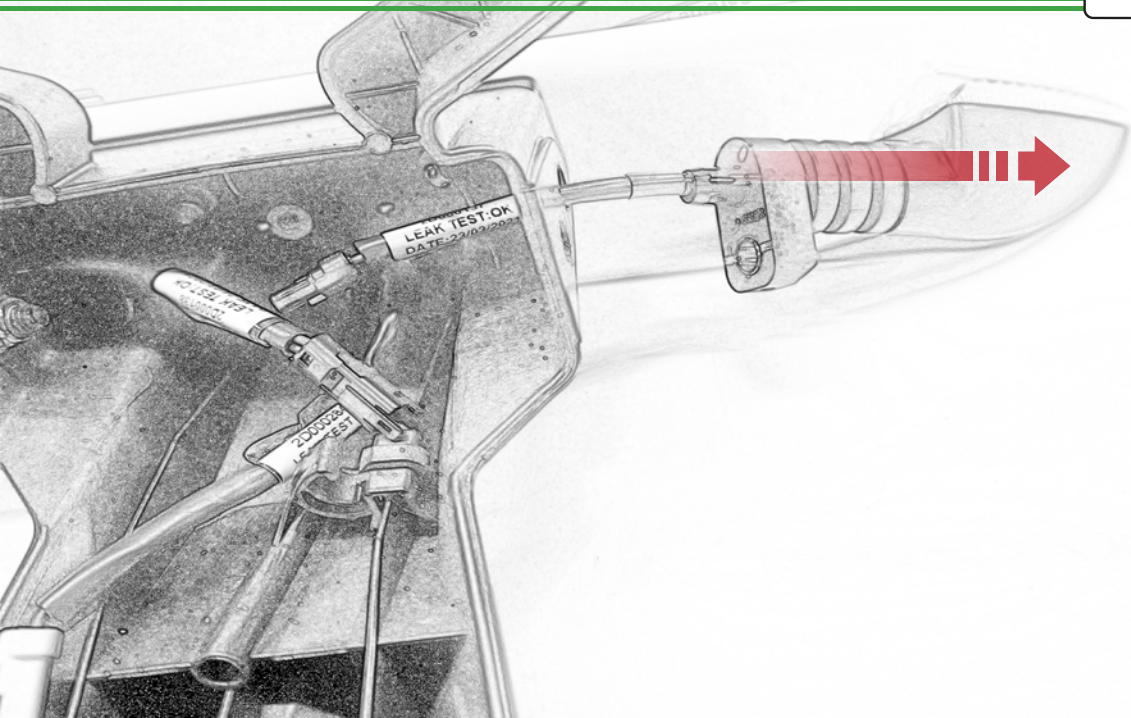

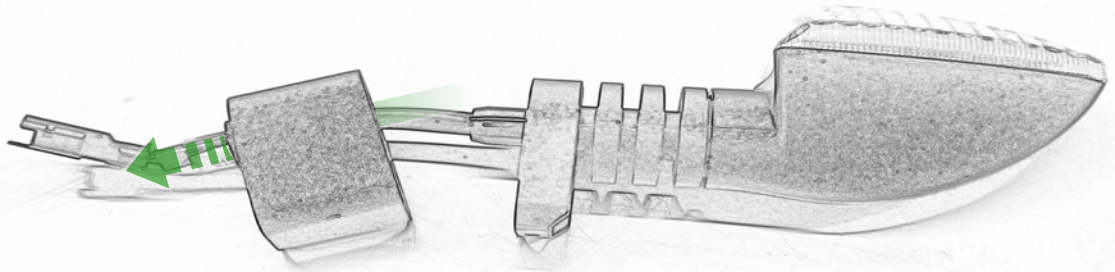

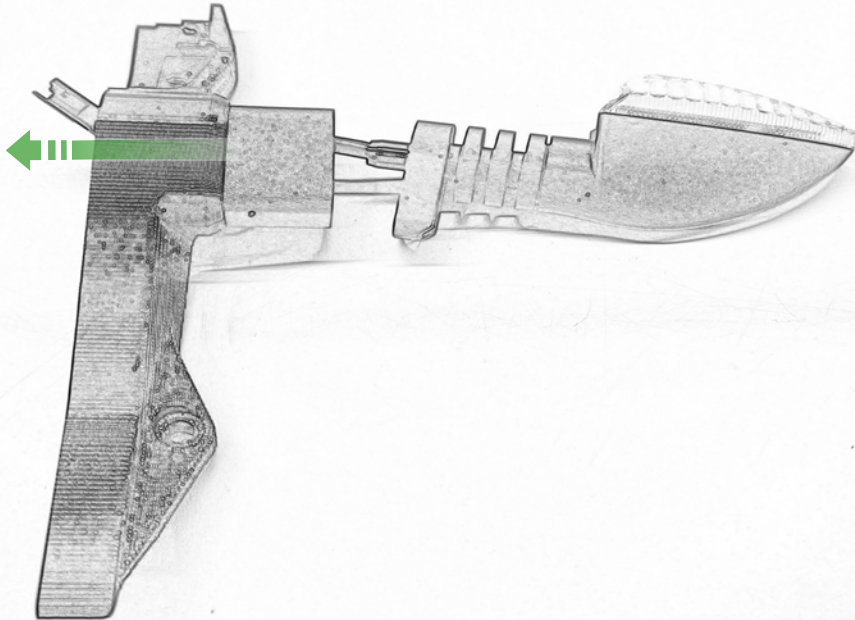

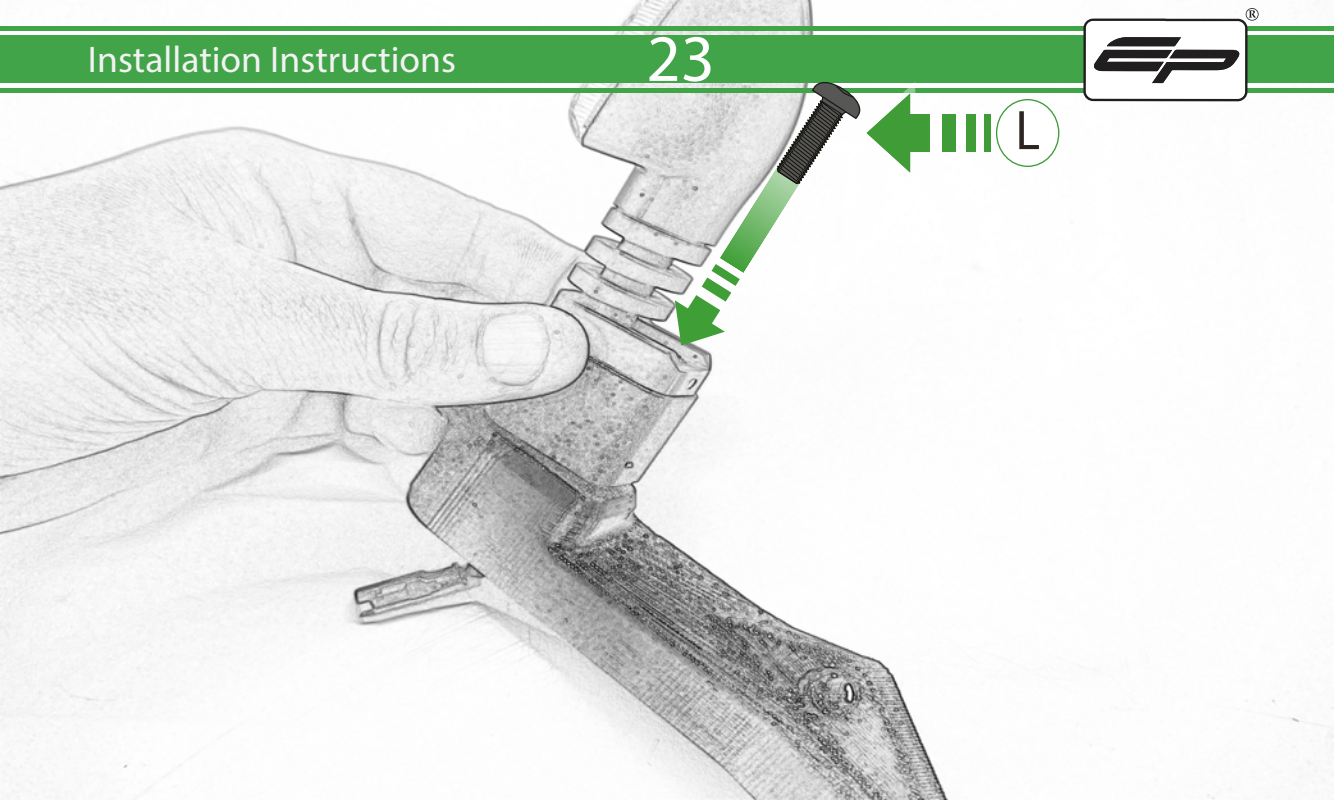

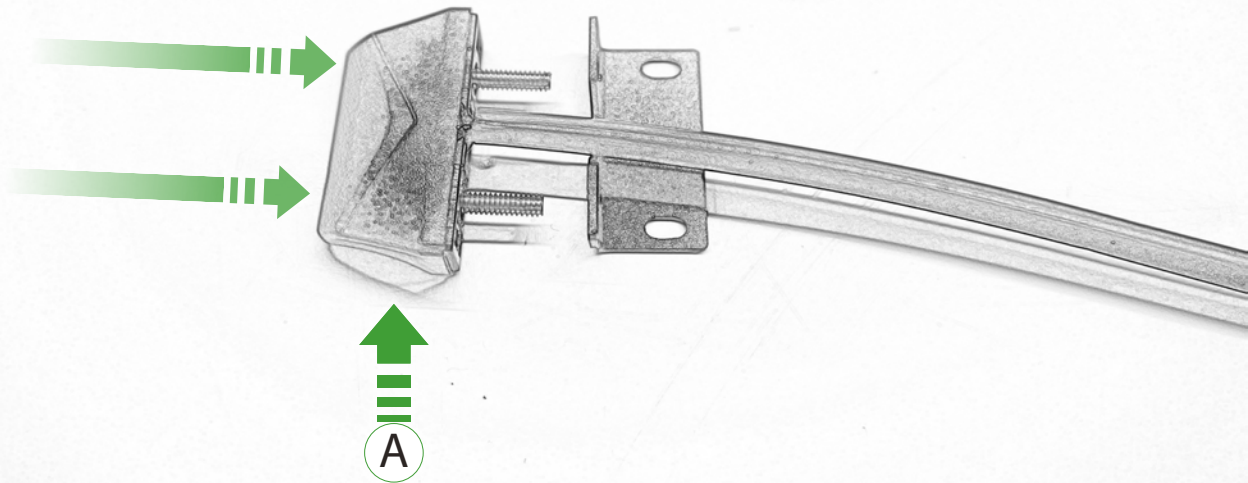

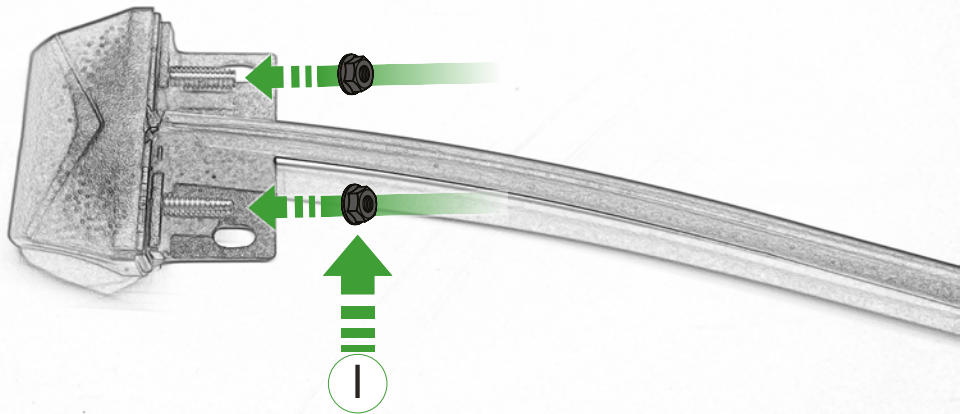



J

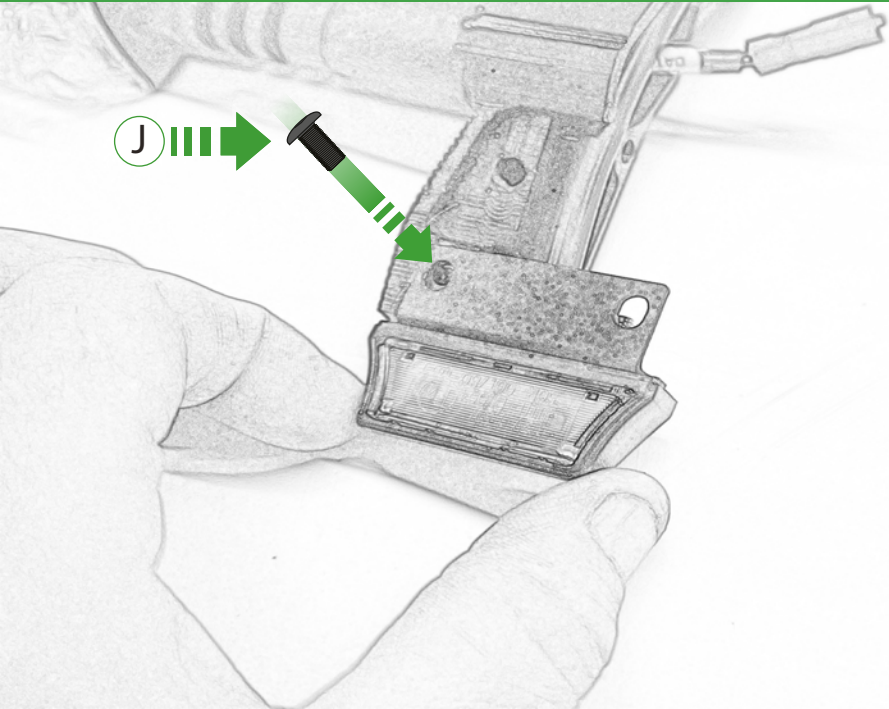

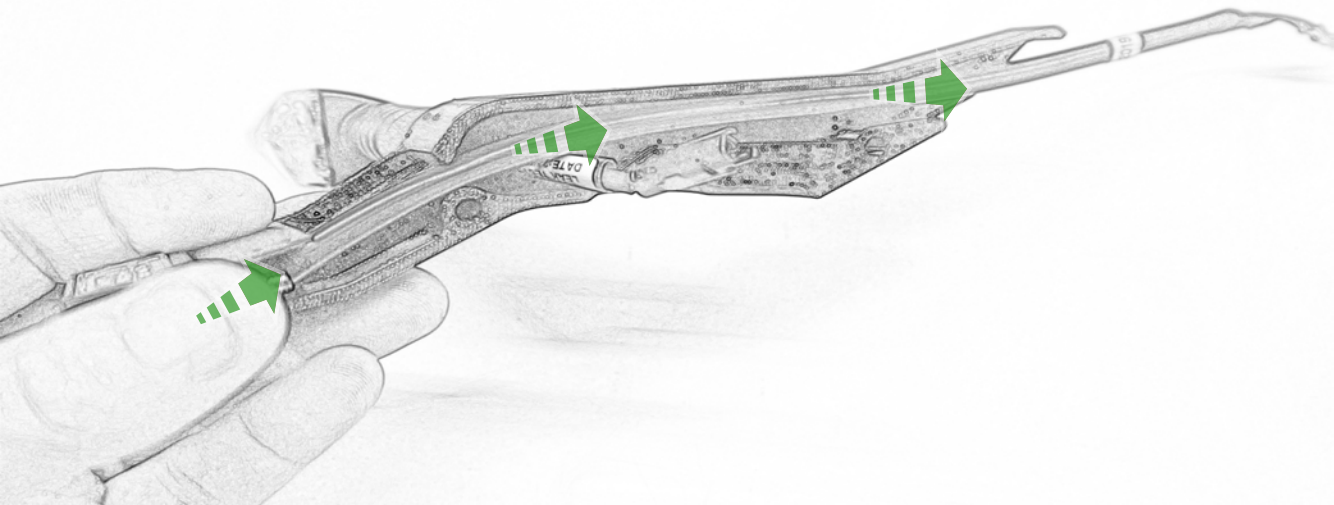

Caution

Run wires neatly down the channel in both parts ensuring they do not get trapped or squashed

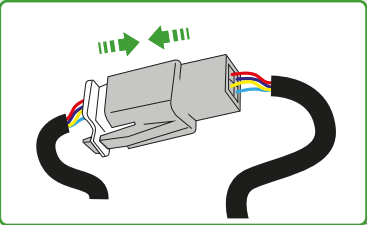
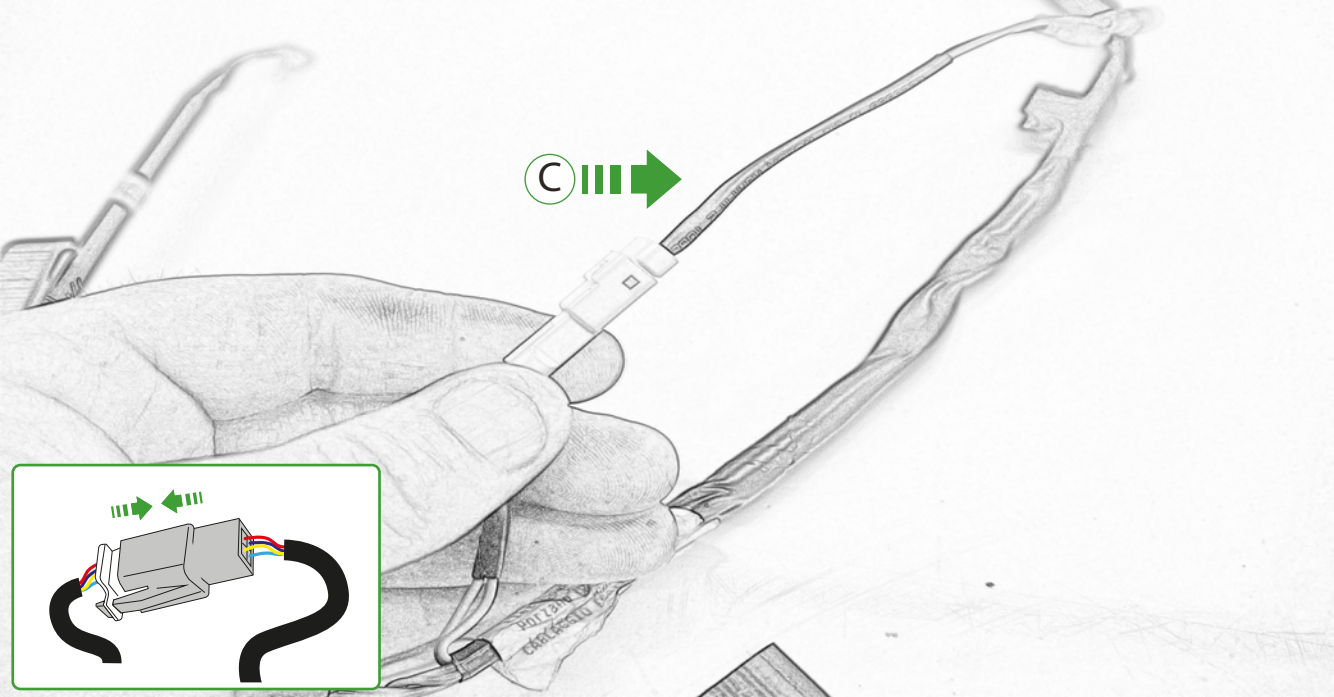

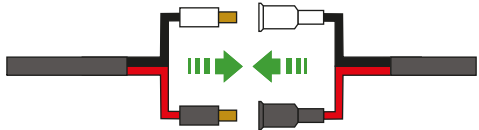
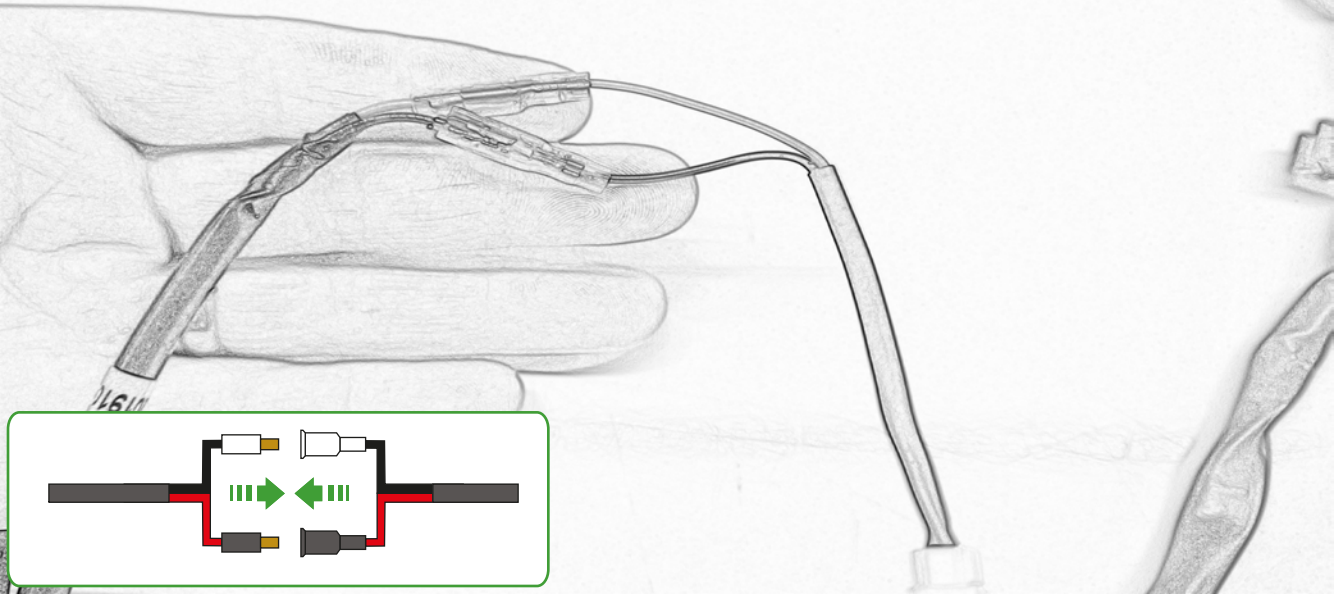

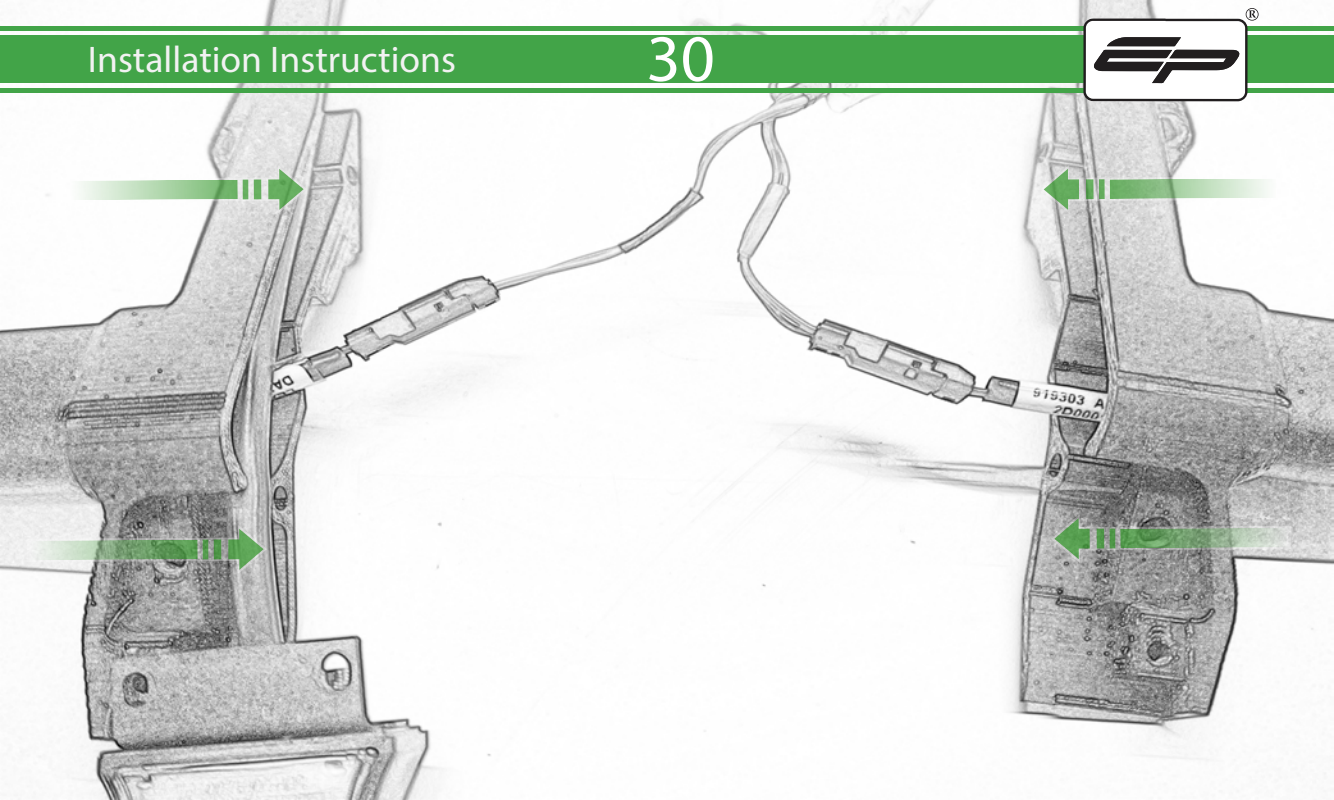

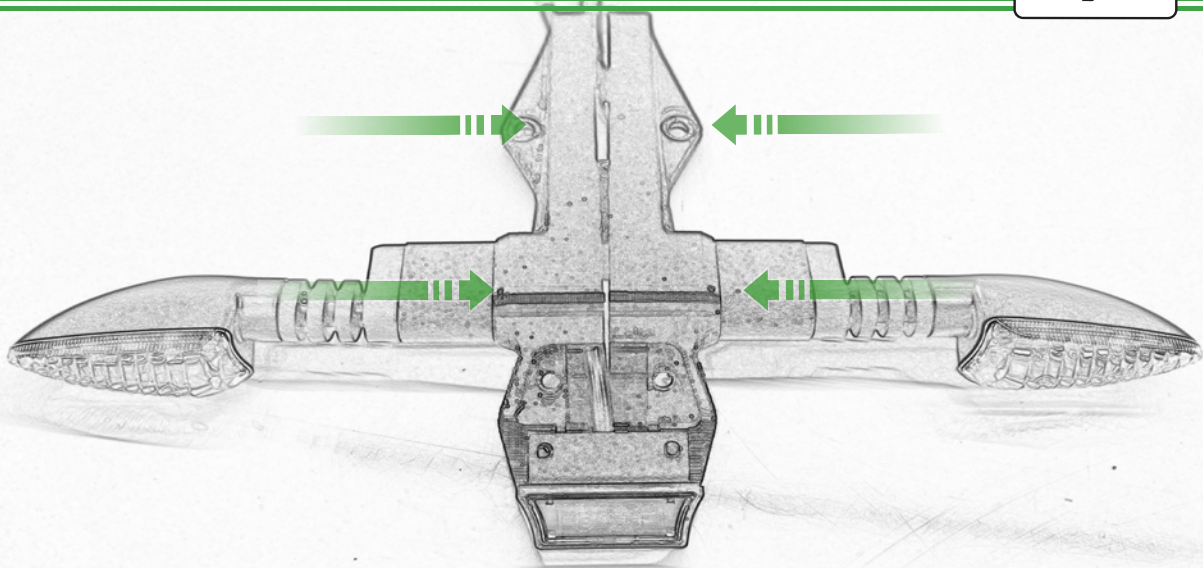

Caution

Run wires neatly down the channel in both parts ensuring they do not get trapped or squashed

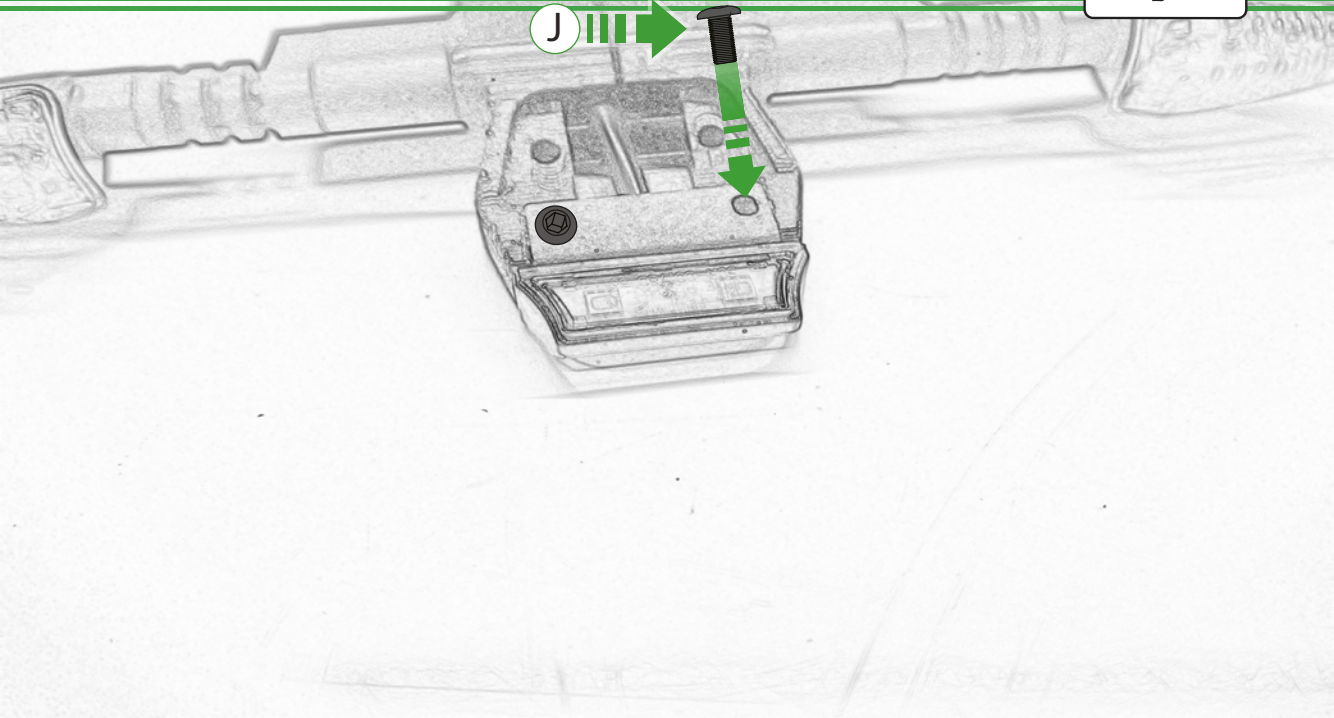

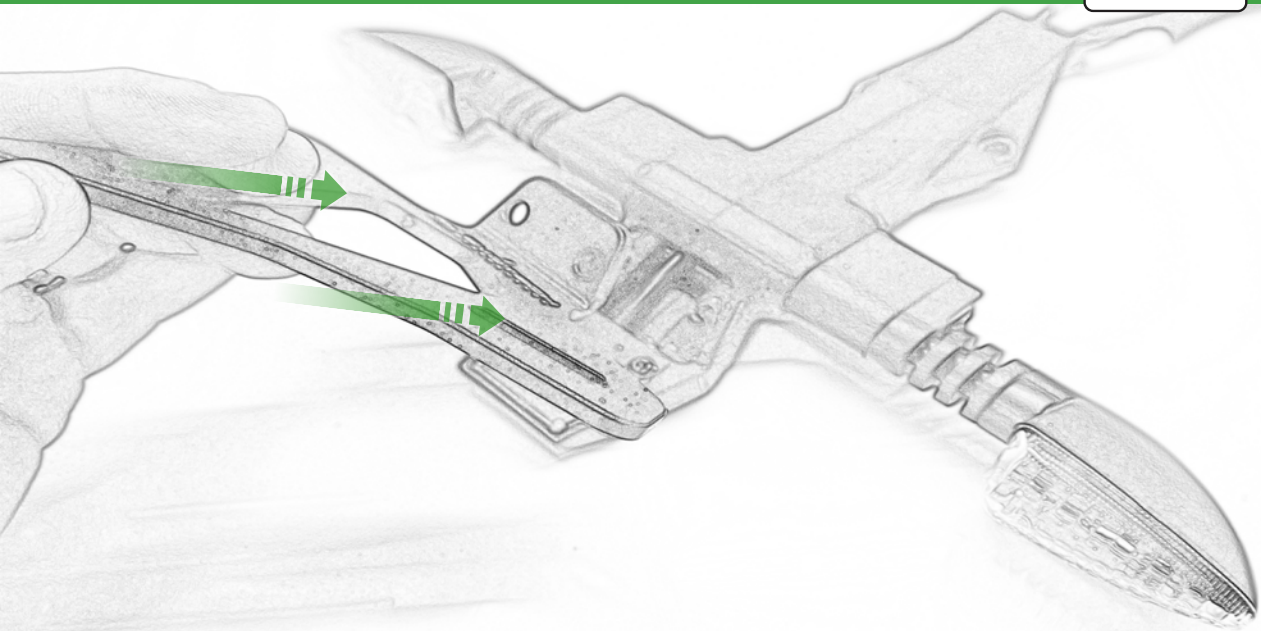

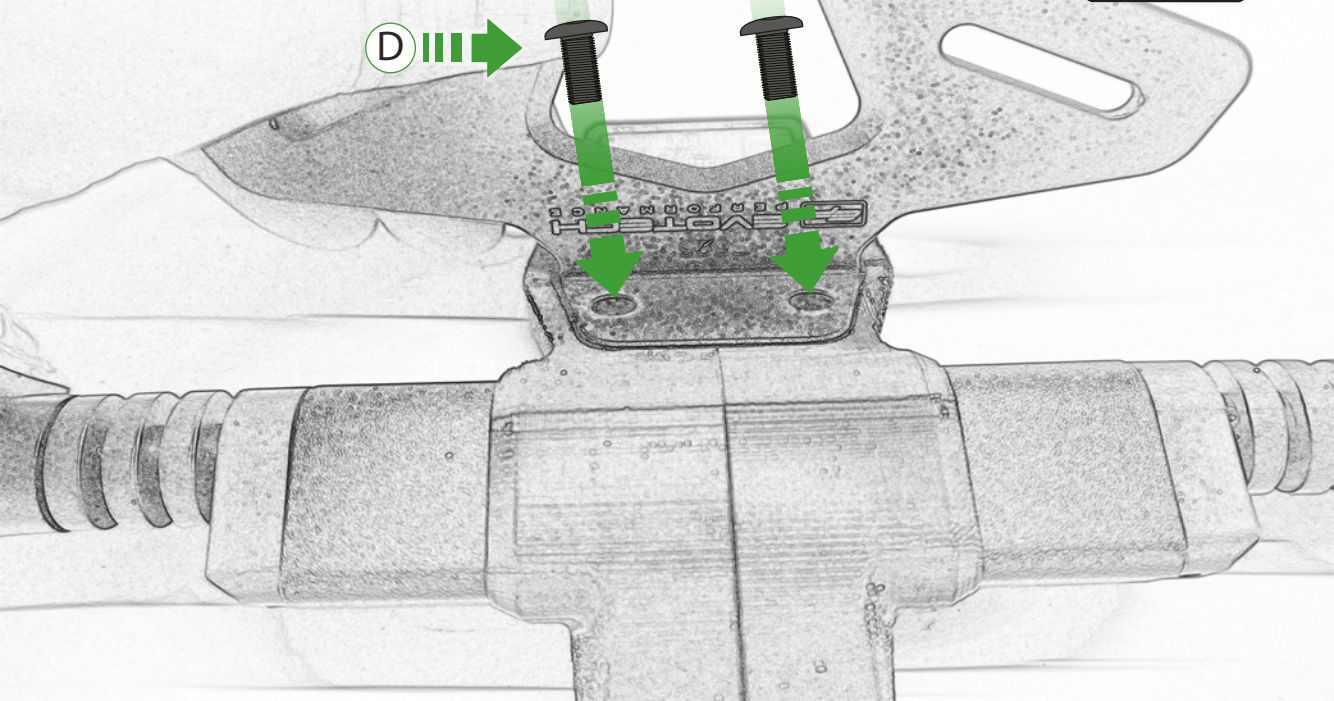

D

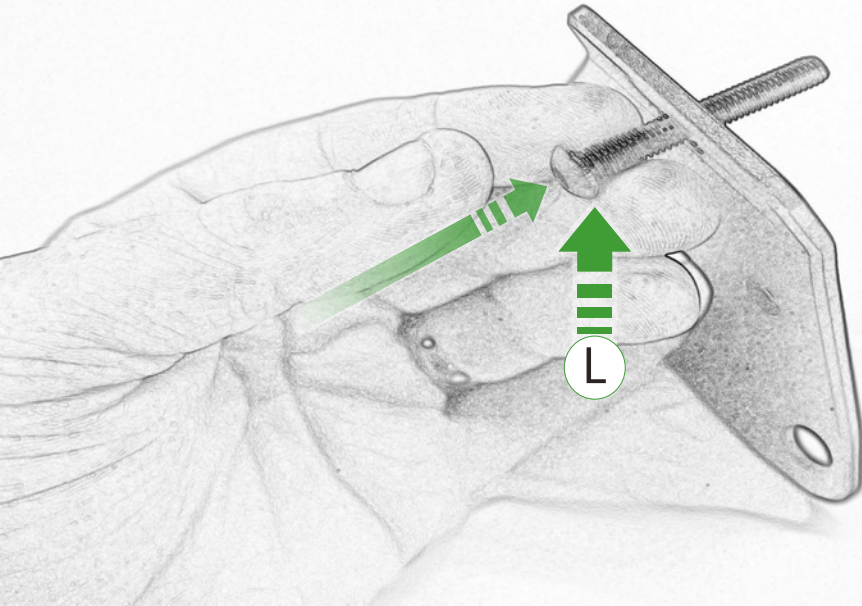

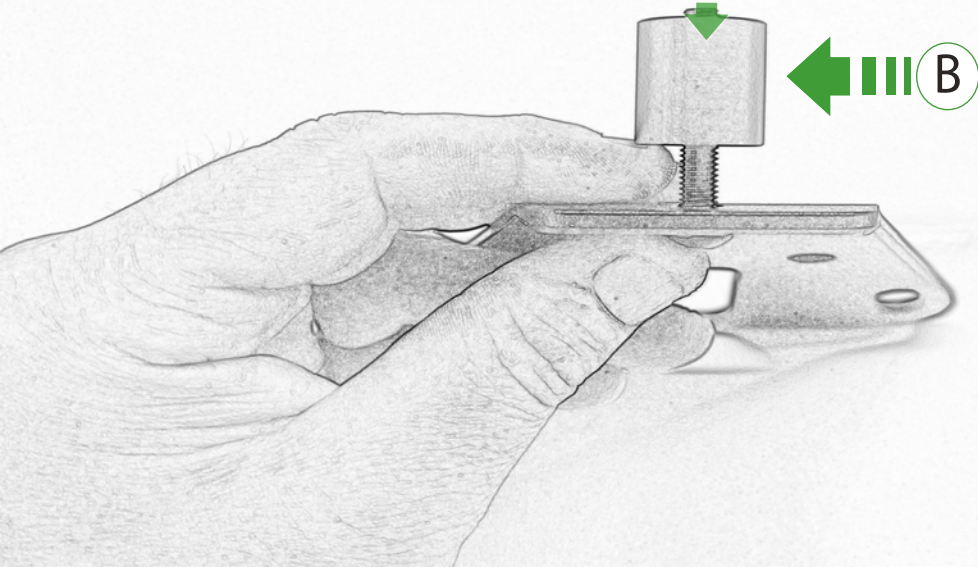

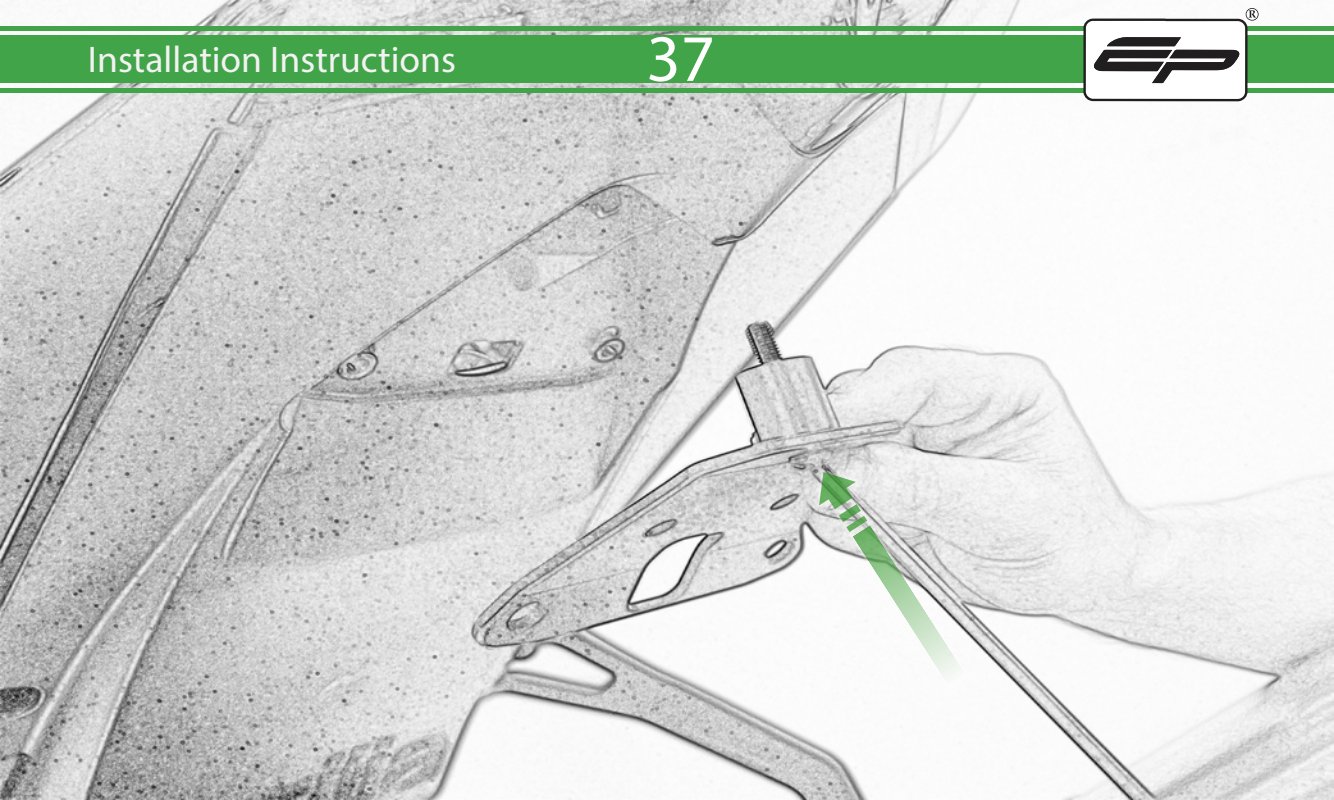

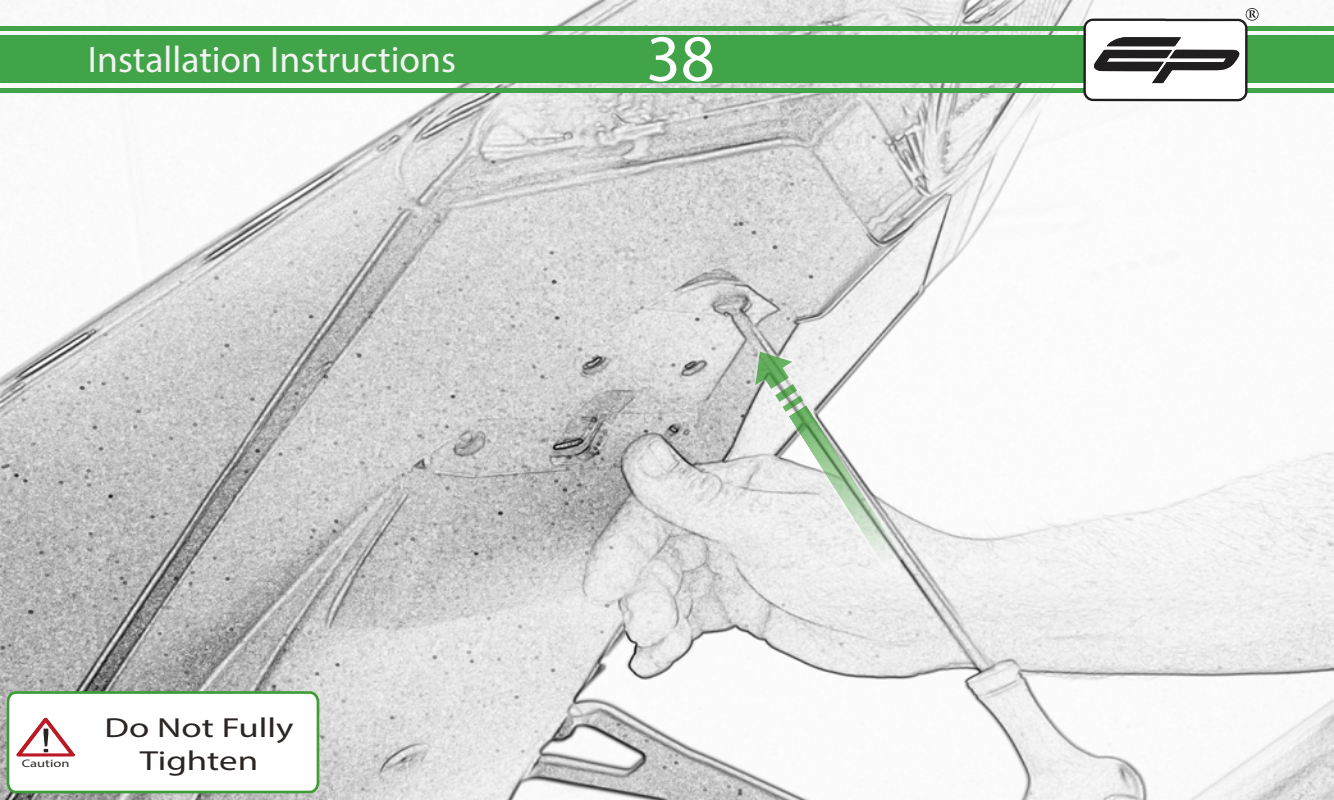

Do Not Fully Tighten

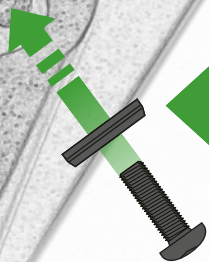
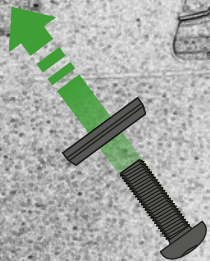
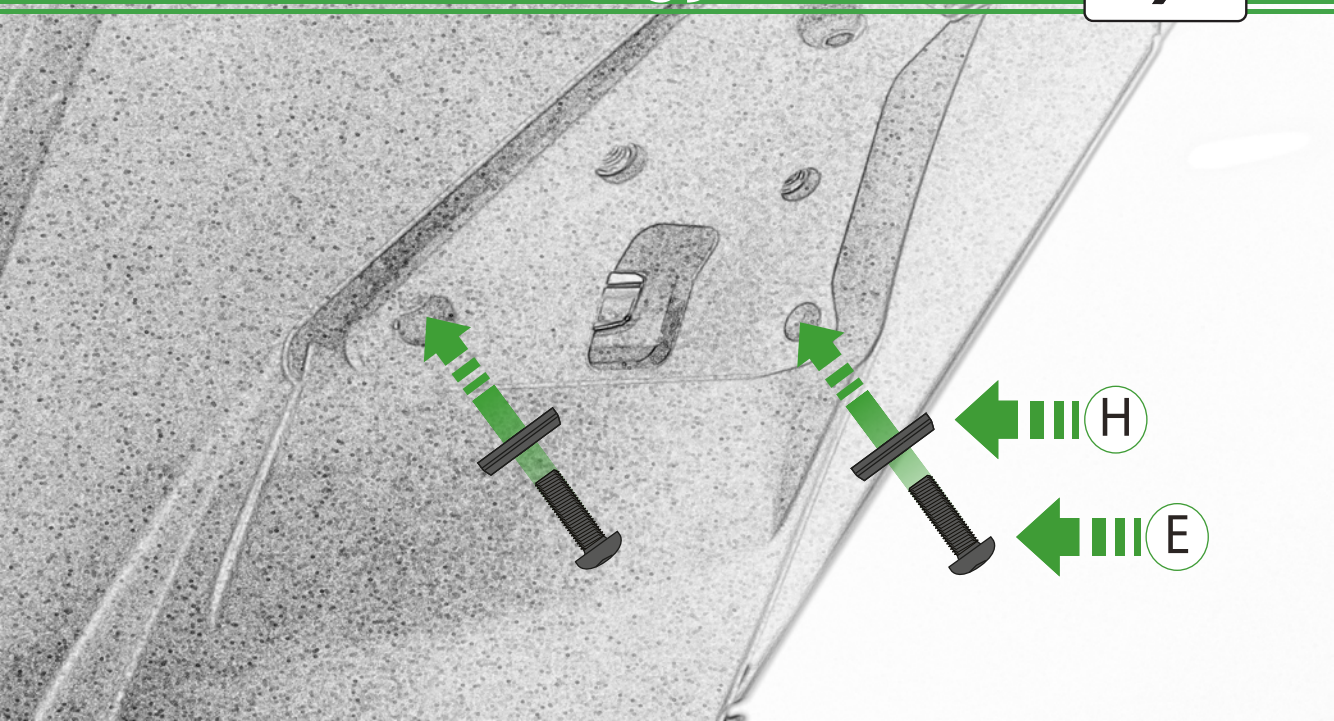

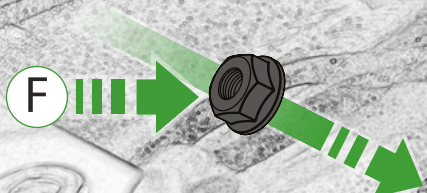

Repeat
Both Sides

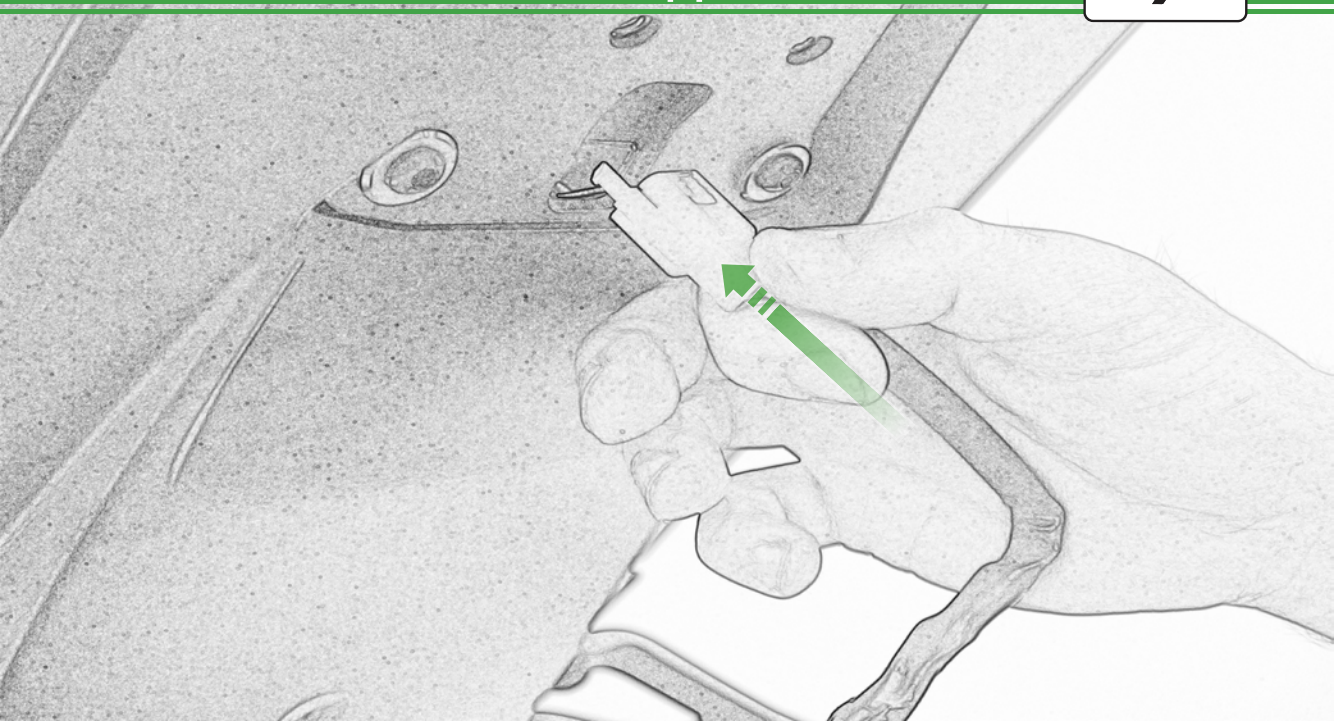

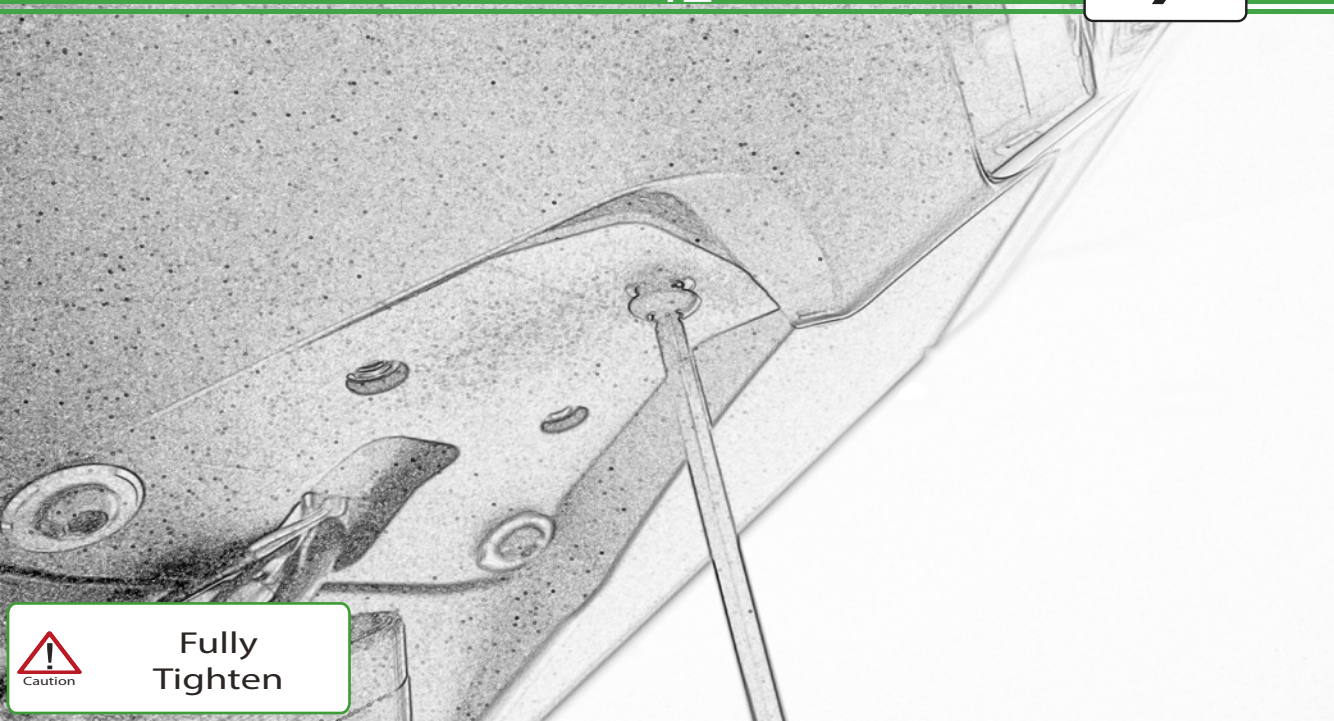

Caution

Fully
Tighten

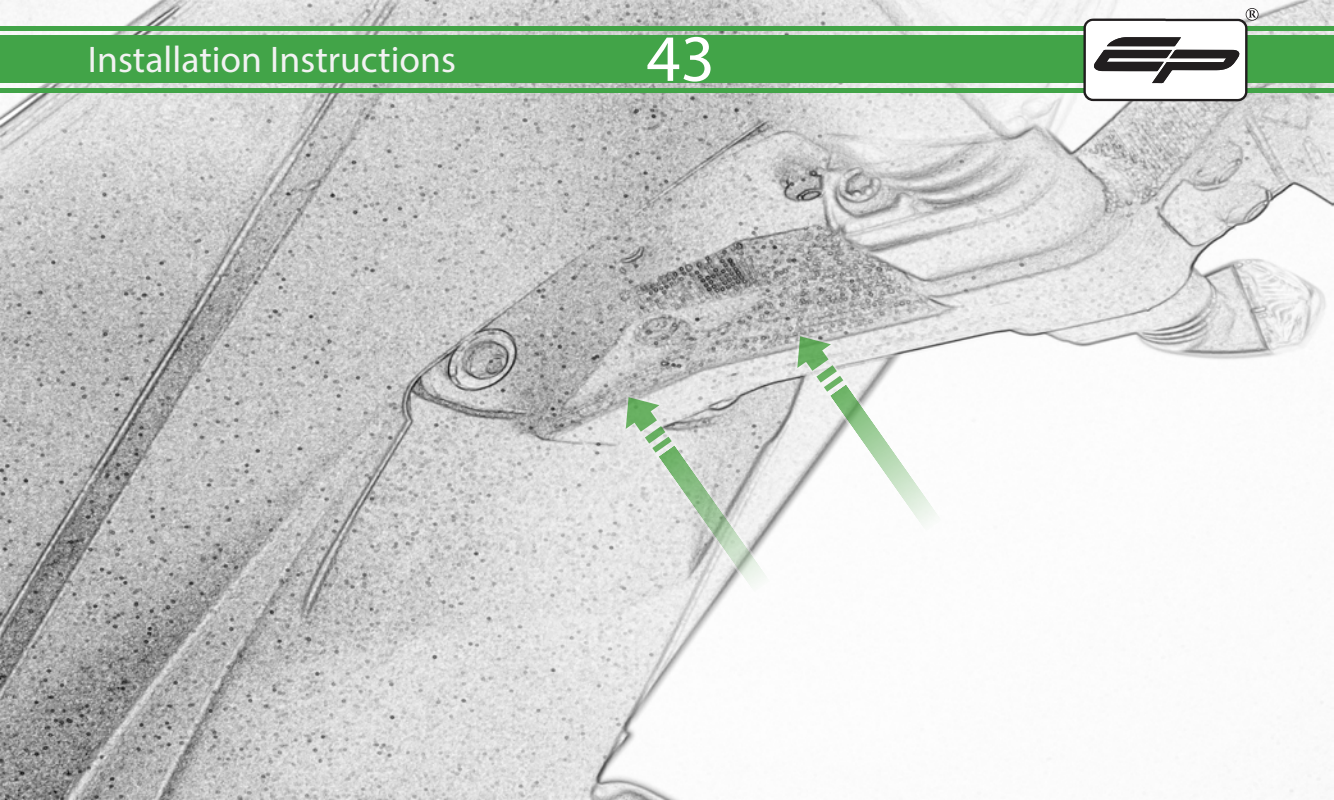

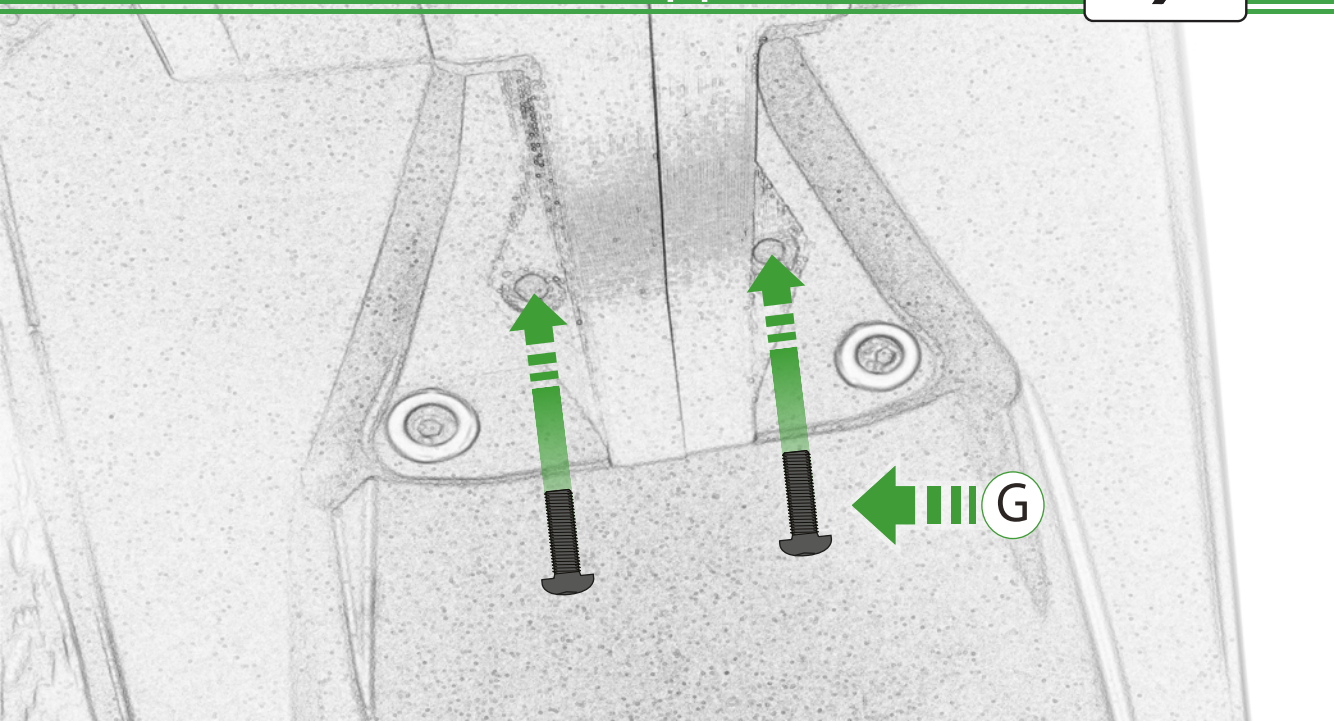

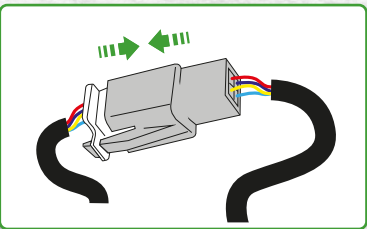
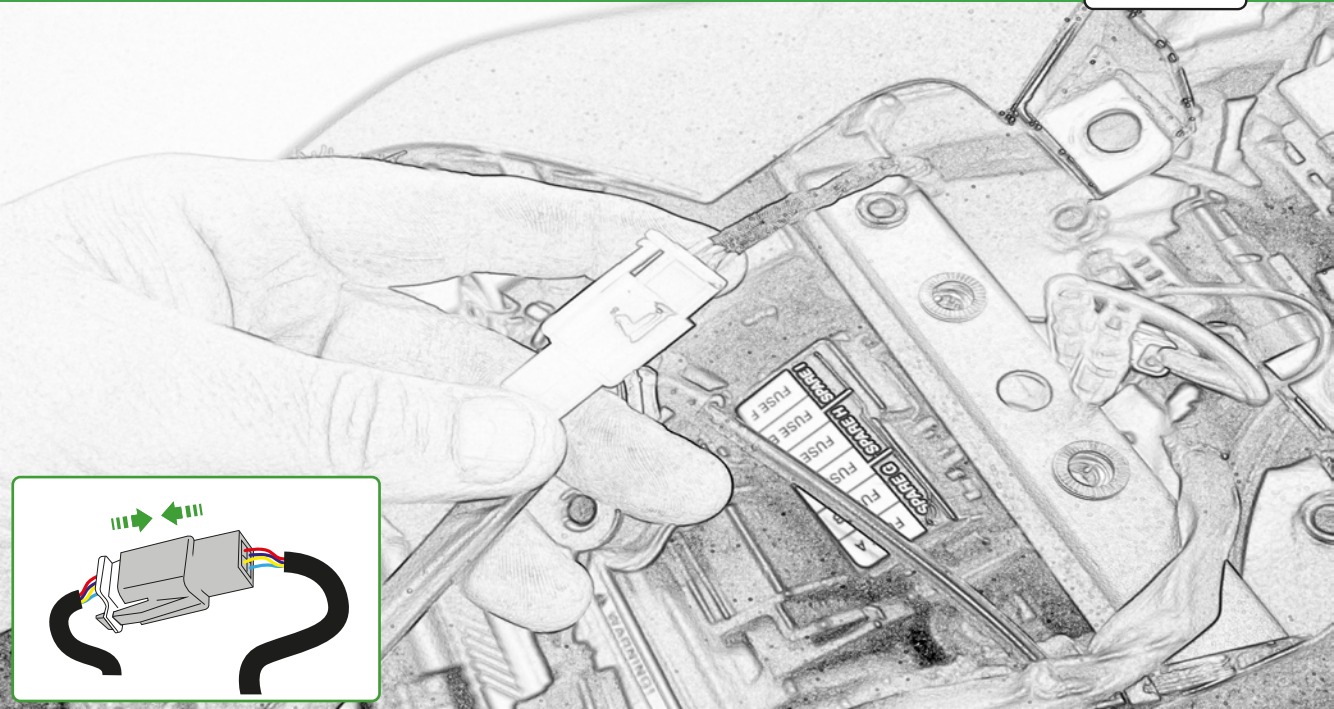

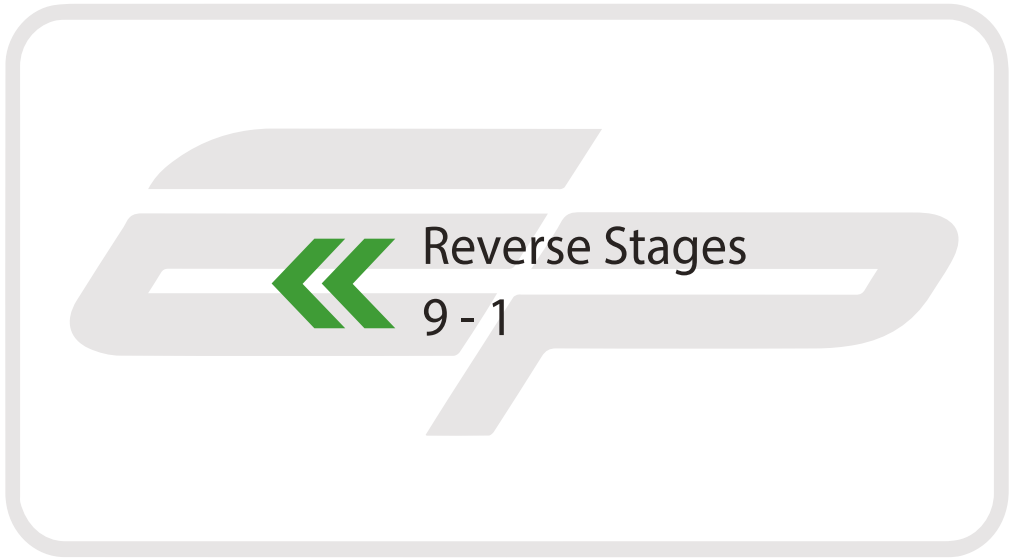

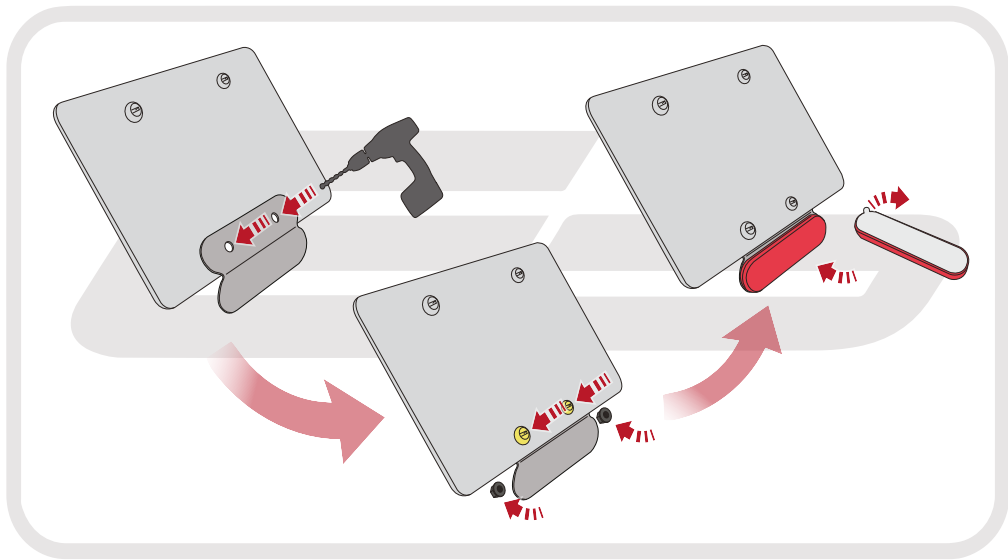

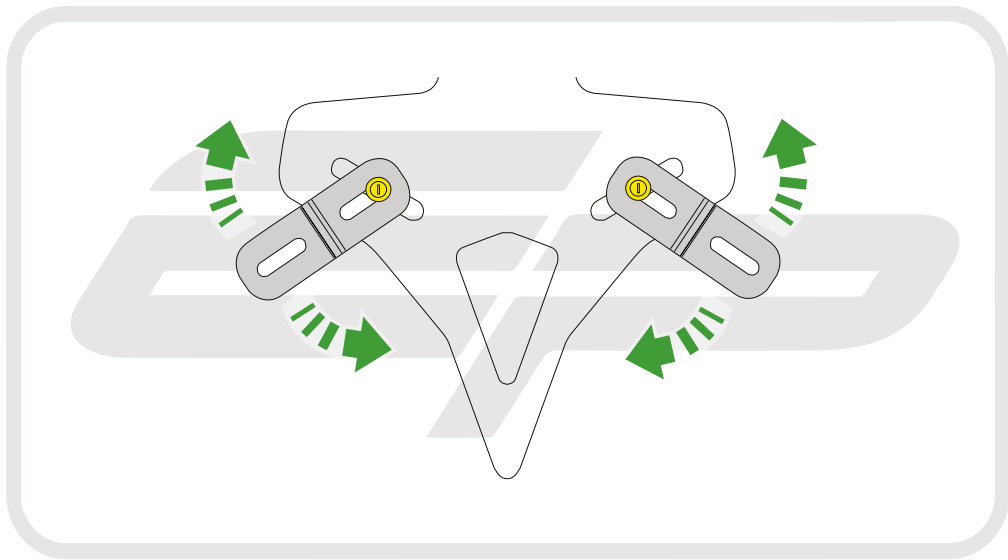



ESSENTIAL CHECKS

After installation of your tail tidy ensure that the licence plate does not contact the rear tyre when suspension is fully compressed.

Ensure all electrics including indicators, tail light, brake light and licence plate light lights are working correctly before riding the motorcycle.

It is recommended that periodic inspections are made to ensure that all fixings are fully tightend.