

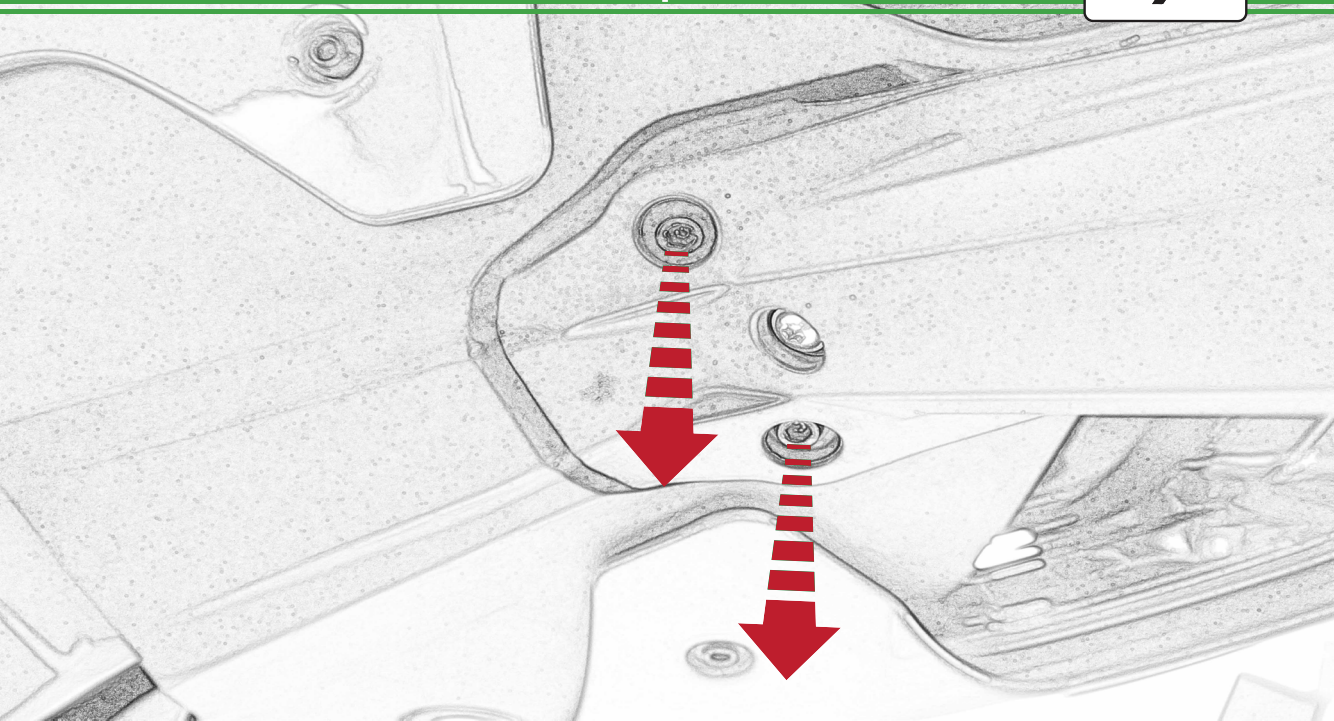

## Kit Contents PRN014957

- Ⓐ 1 x Reflector Kit
- Ⓑ 1 x Connector Type 10
- Ⓒ 1 x EP Number Plate Light
- Ⓓ 1 x M4 x 10 Button Head Bolt
- Ⓔ 2 x M4 Nuts
- Ⓕ 2 x M5 x 12 Button Head Bolt
- Ⓖ 2 x M6 x 16 Button Head Bolt
- Ⓗ 2 x M5 x 16 Button Head Bolt
- Ⓘ 2 x M5 x 70 Caphead Bolt (Double Stem Version)
- Ⓙ 2 x M5 x 40 Caphead Bolt (Single Stem Version)
- Ⓚ 2 x Indicator Adaptors
- Ⓛ 4 x Indicator Stems
- Ⓜ 4 x Indicator Clamps

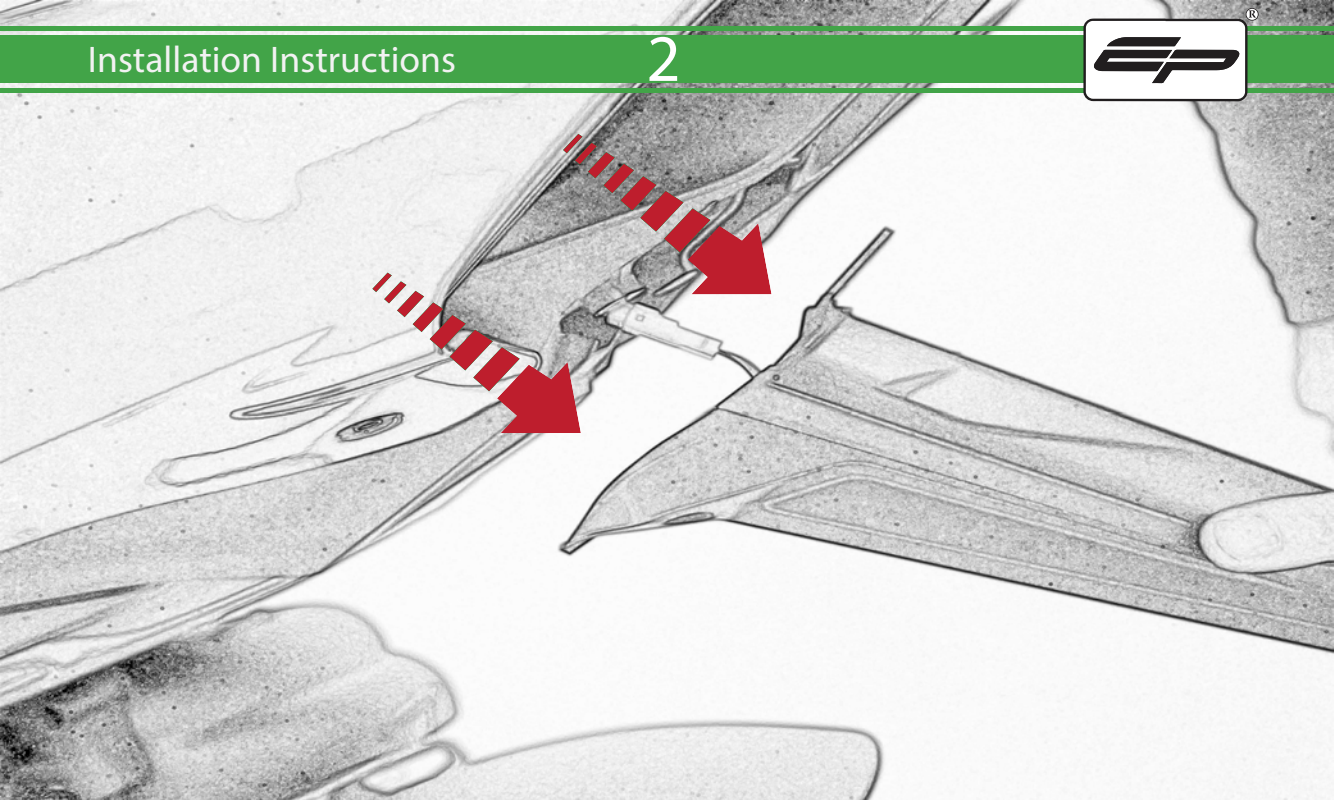



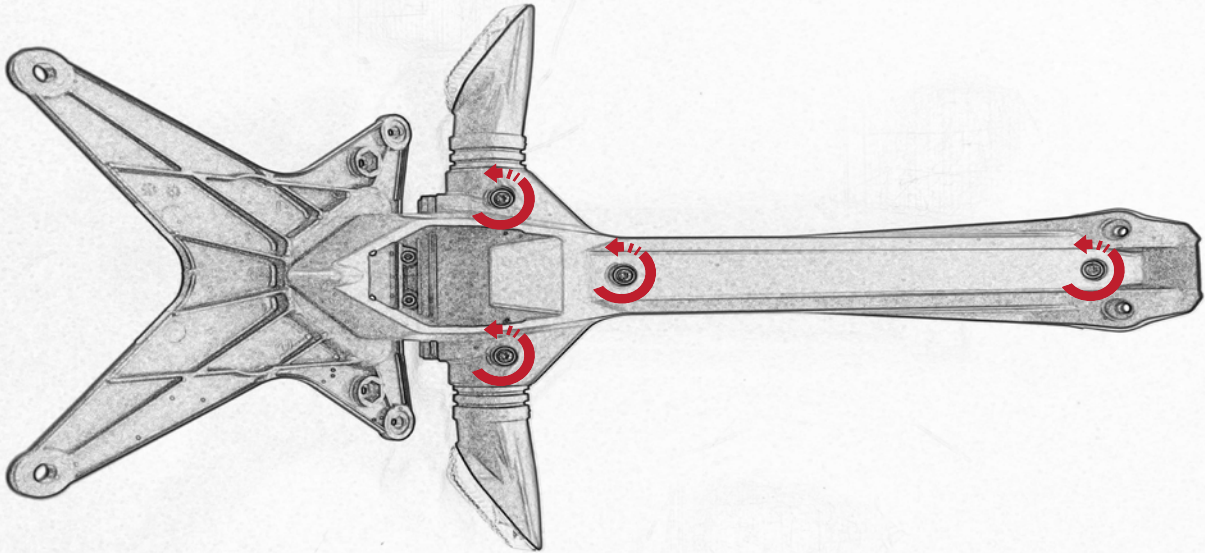

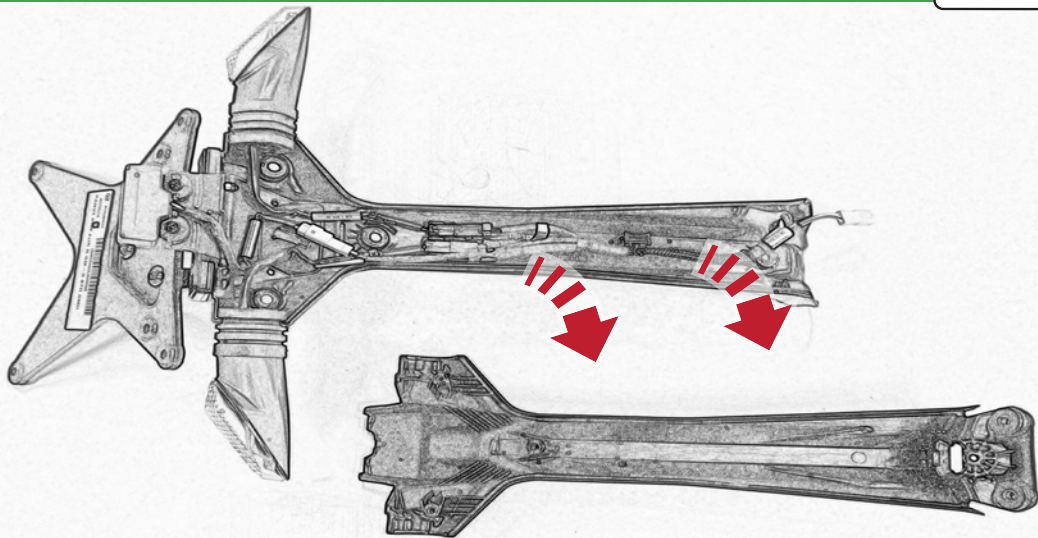

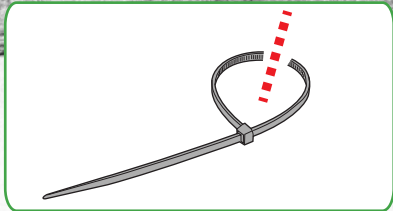
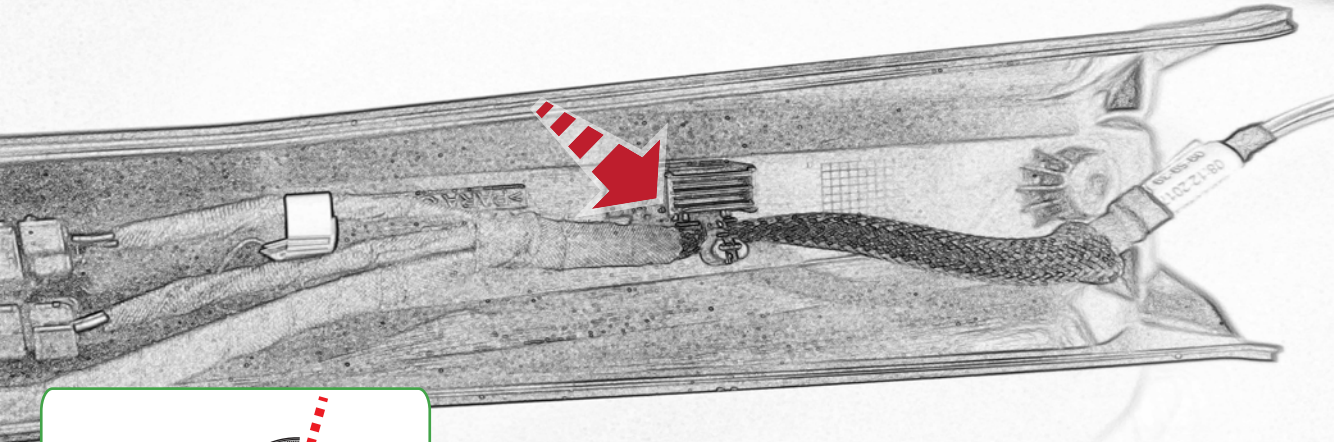



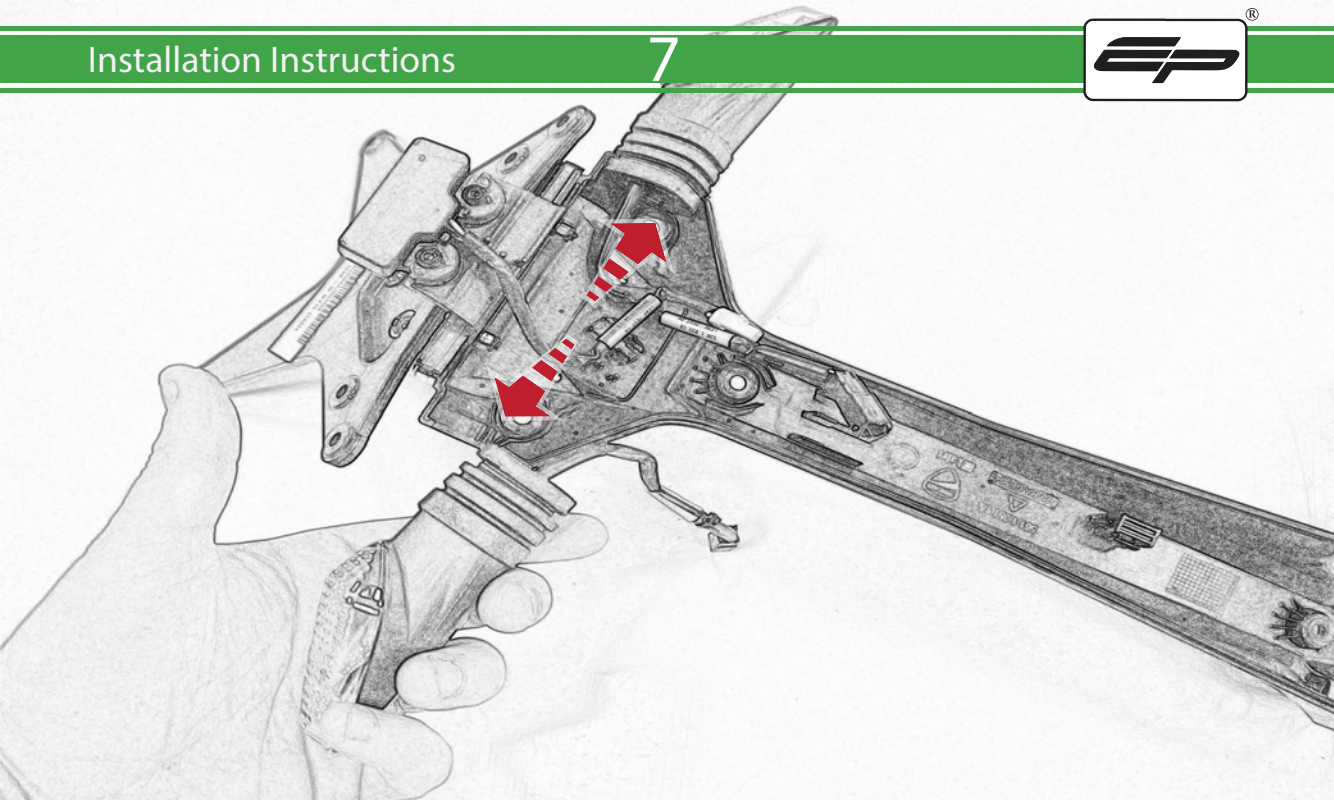



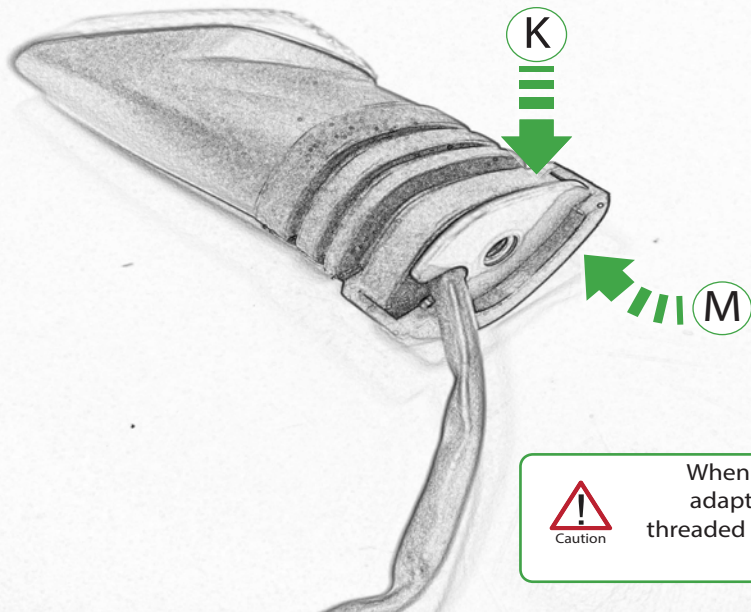

Repeat  
Both Sides



When fitting the indicator  
adaptor plate ensure the  
threaded insert is facing towards  
the indicator

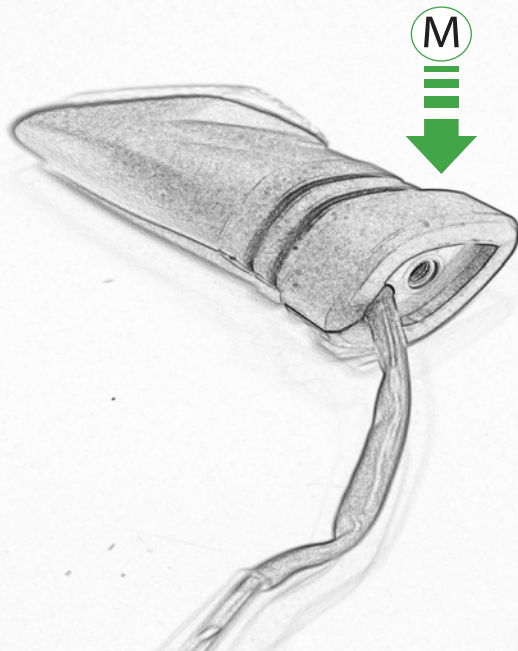

Repeat  
Both Sides

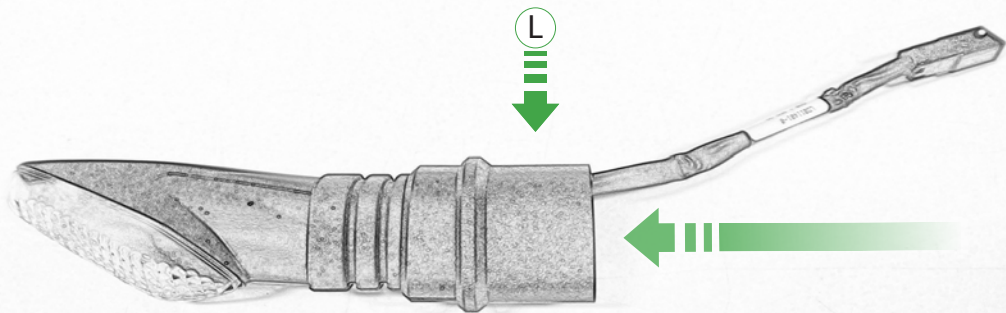

Repeat  
Both Sides

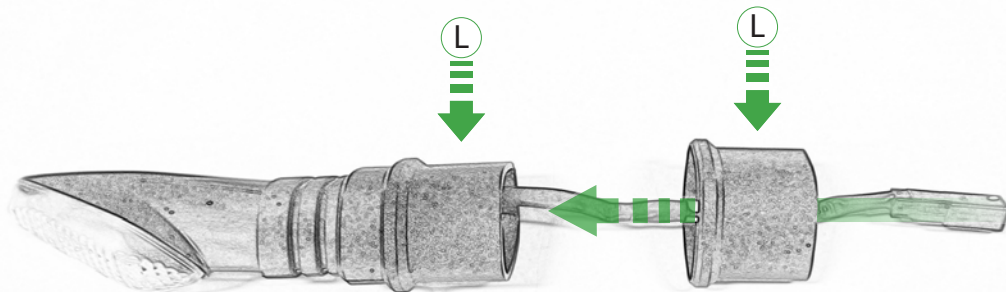

Repeat  
Both Sides



Second stem only required  
for large numberplates

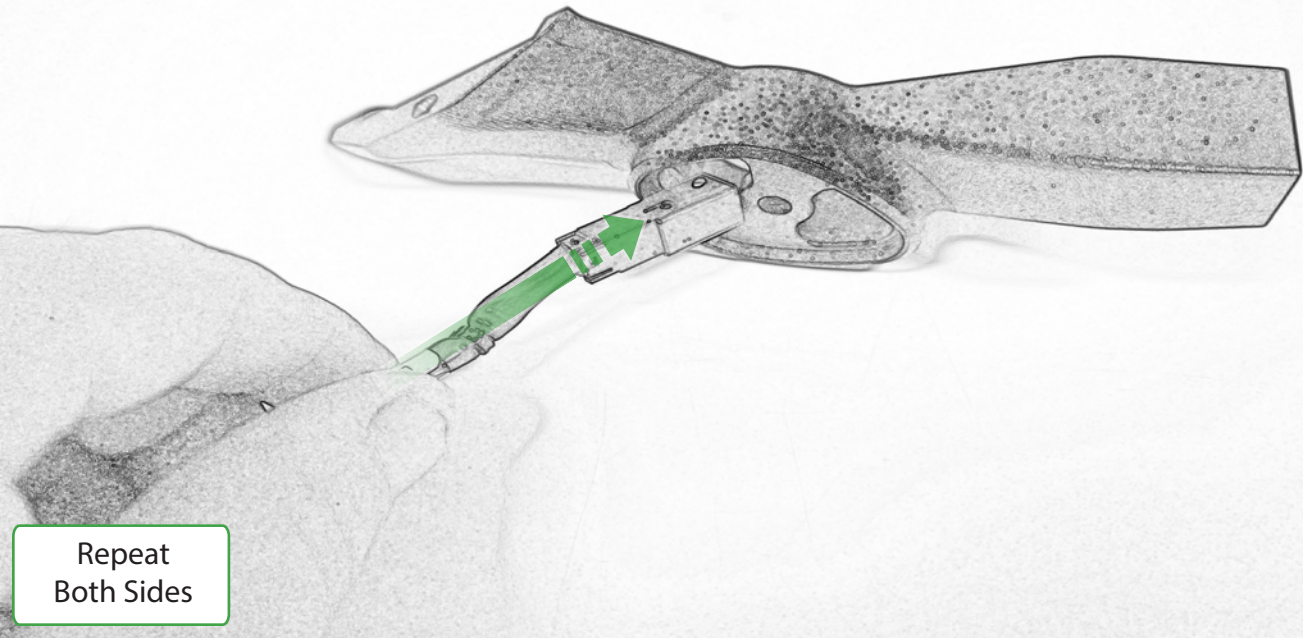

Repeat  
Both Sides

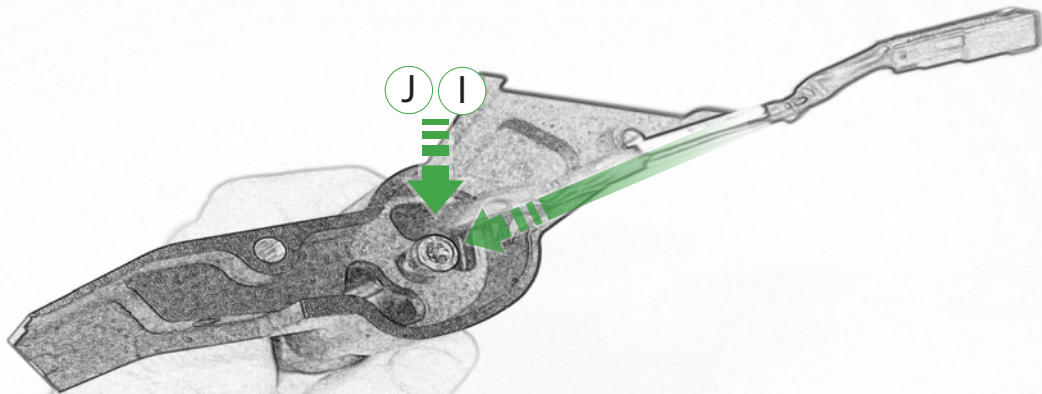

Repeat  
Both Sides

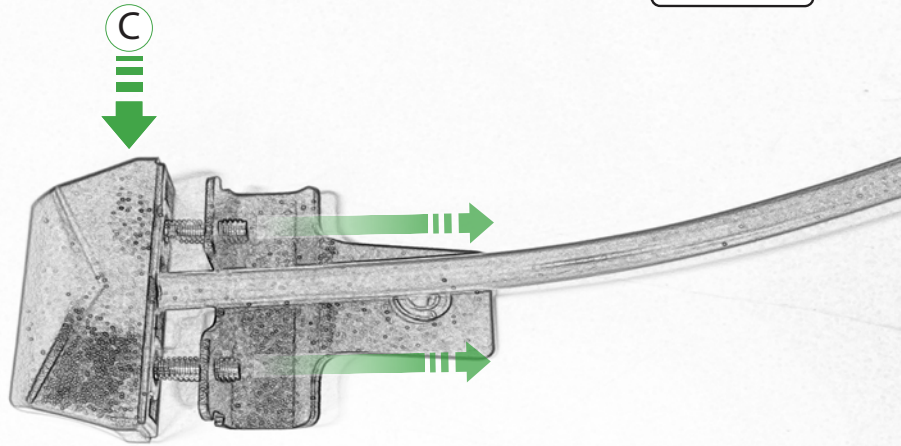

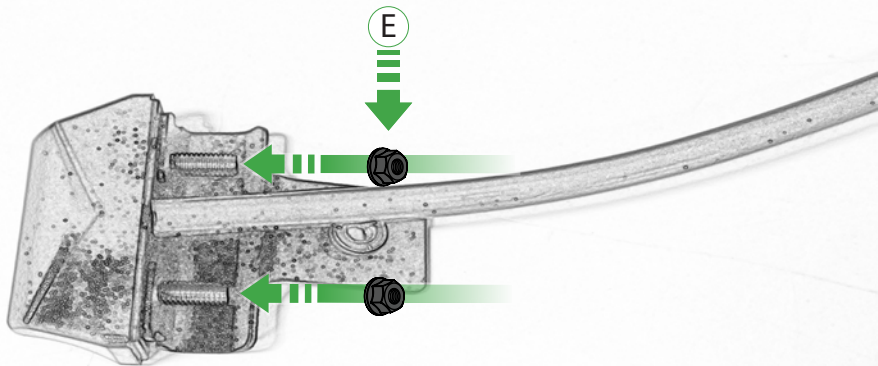



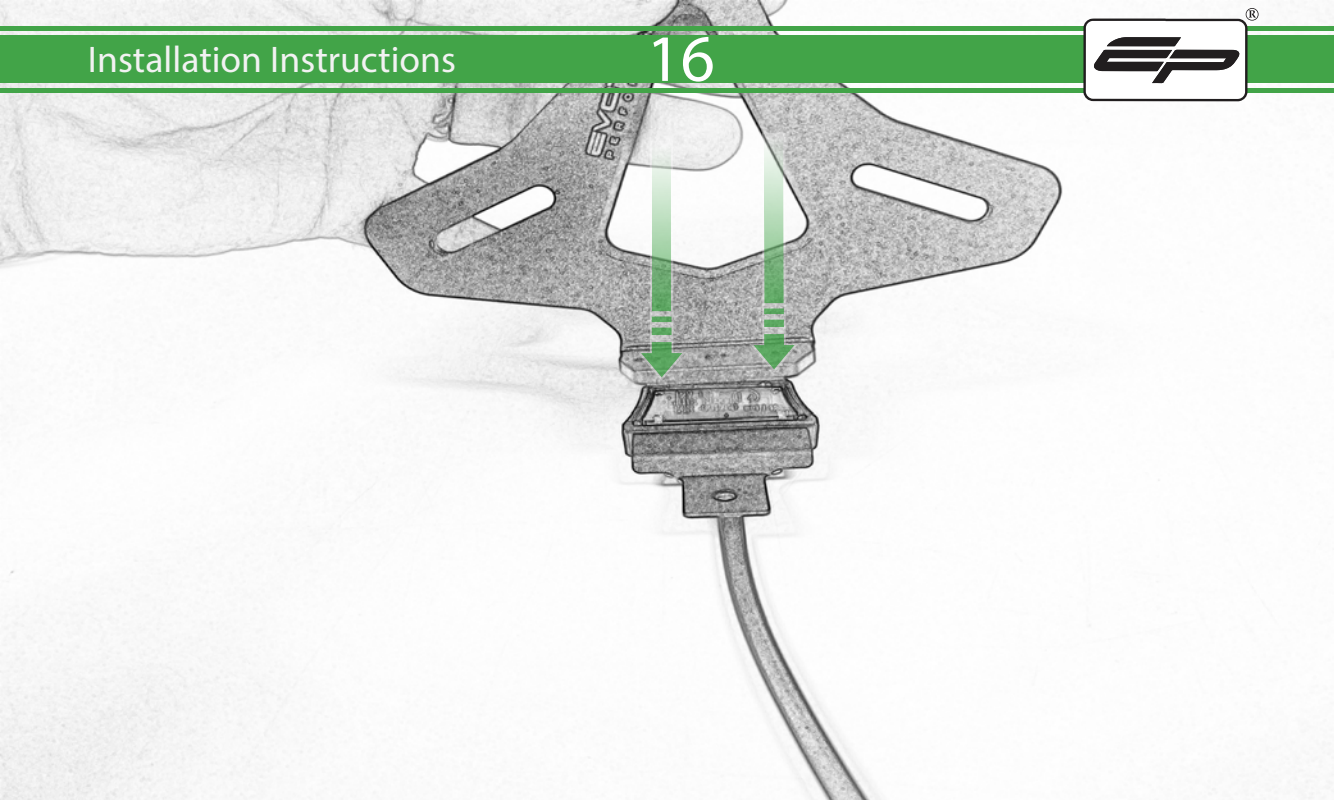

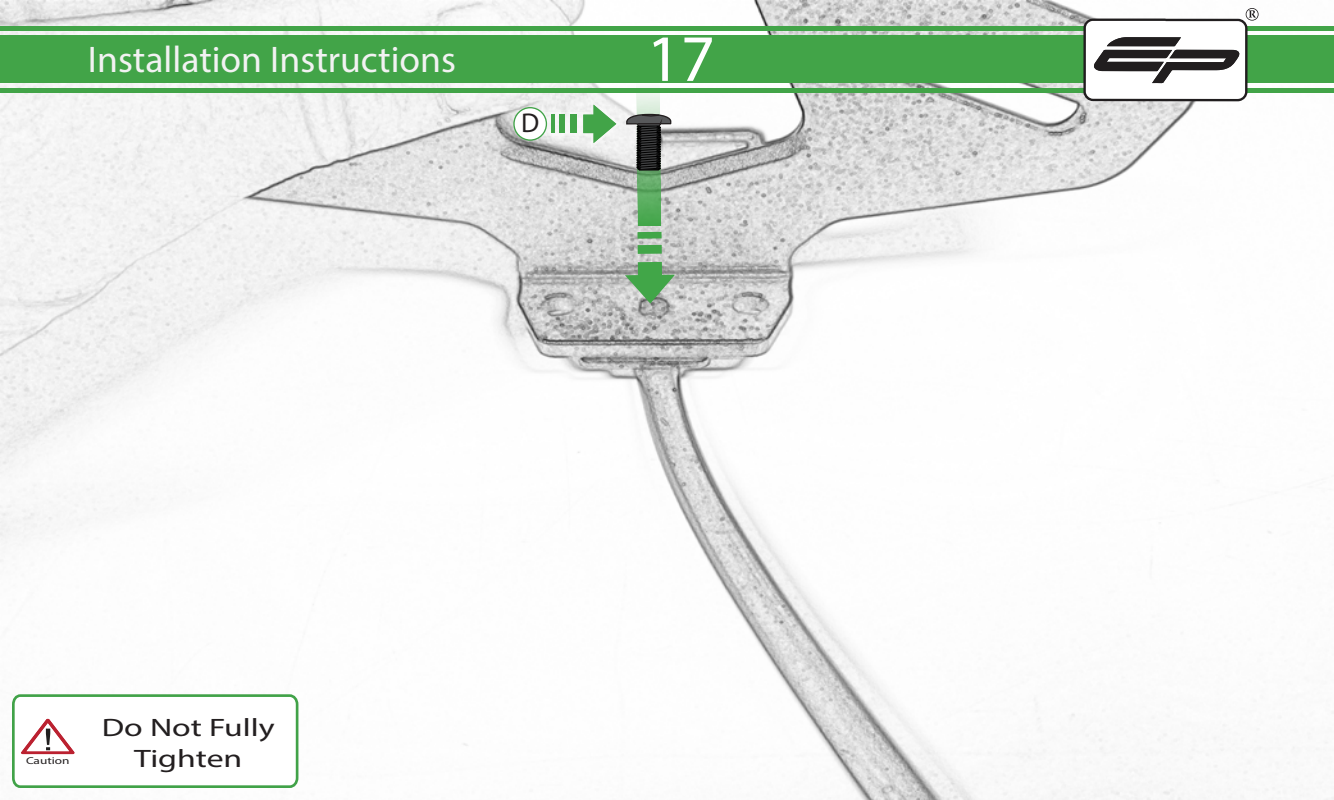

Caution

Do Not Fully  
Tighten

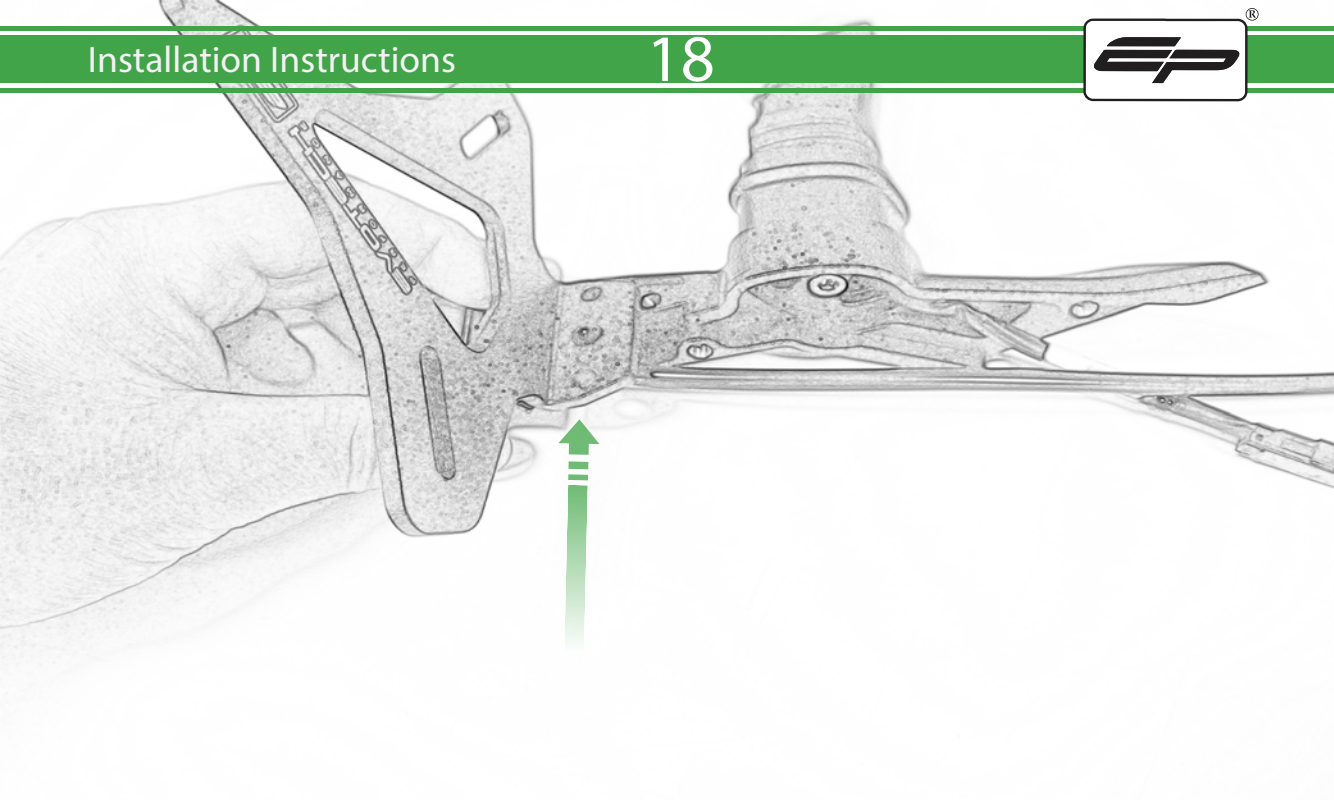

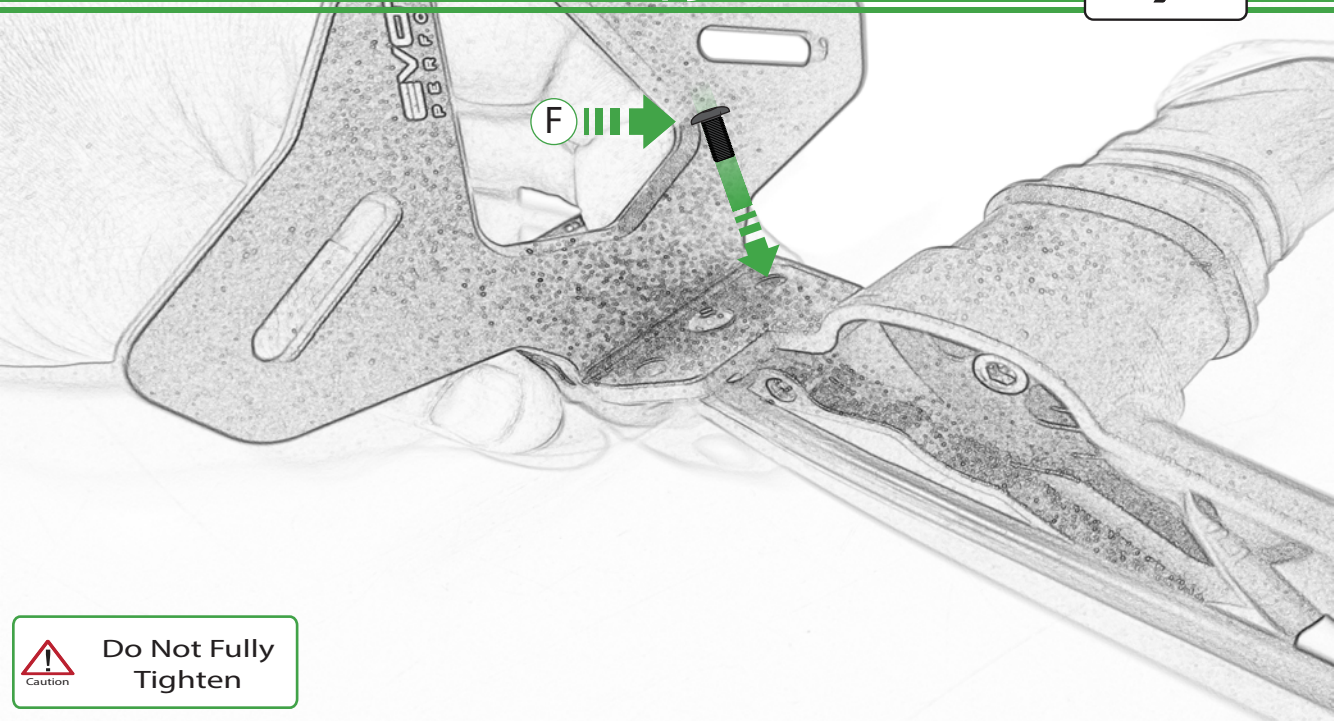

F



Caution

Do Not Fully  
Tighten

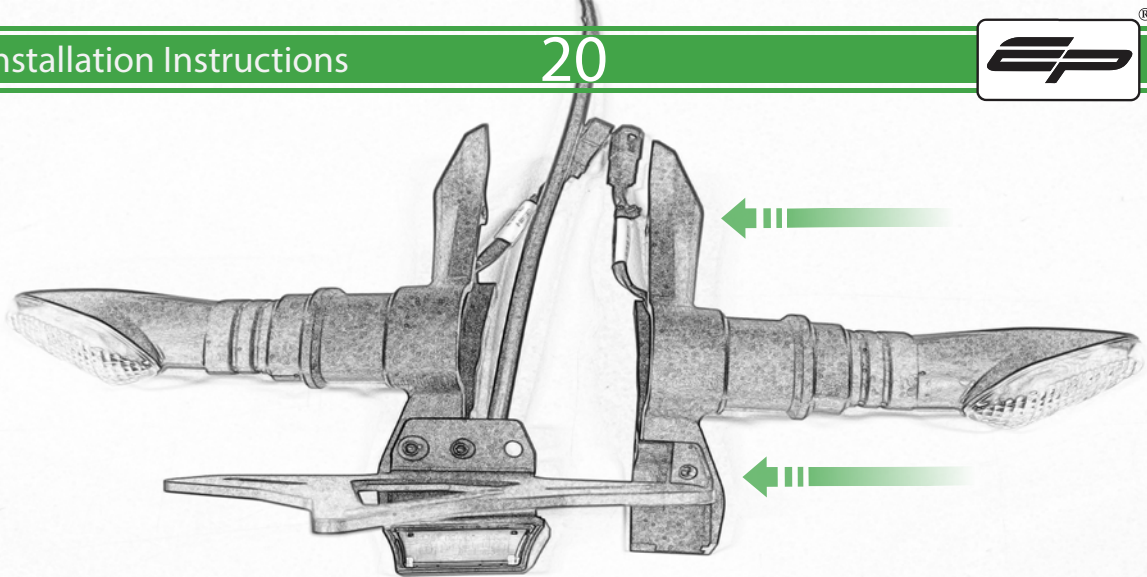

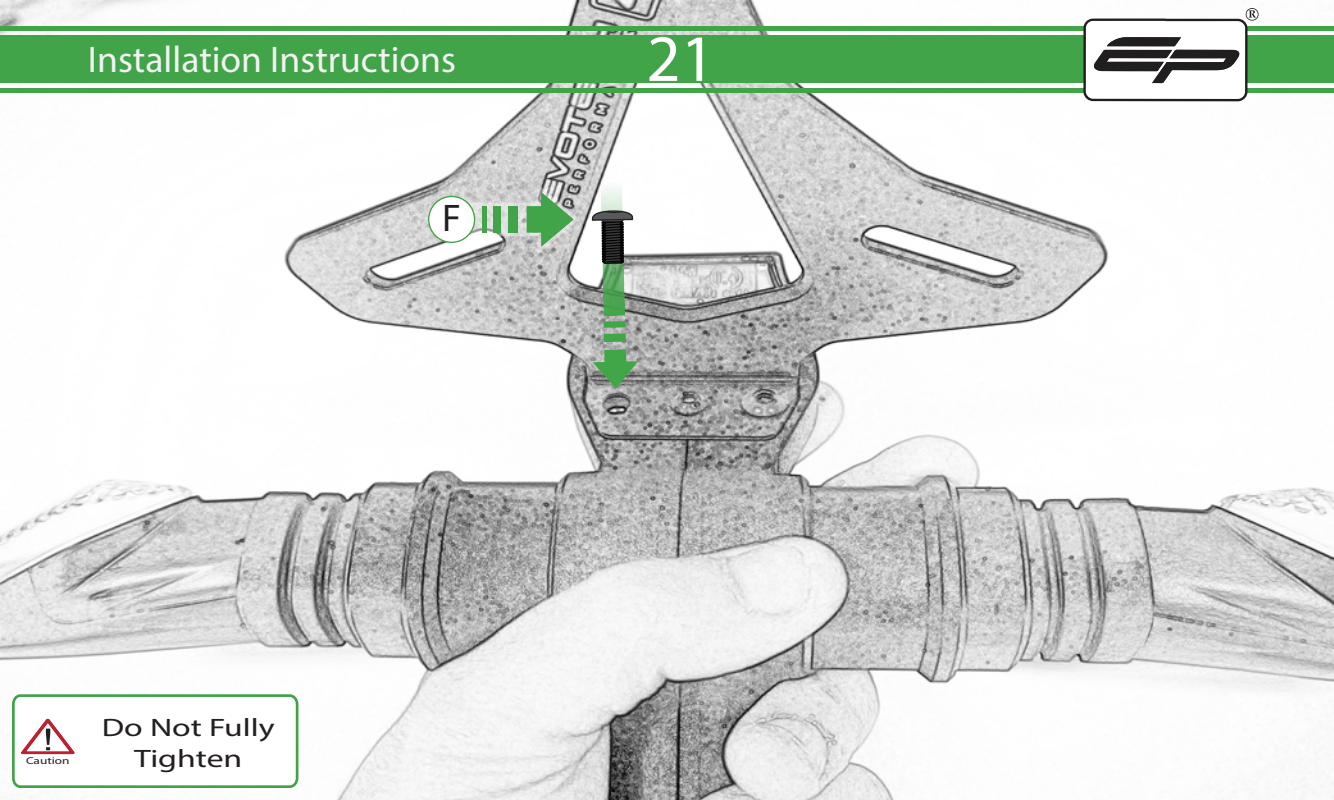

Do Not Fully  
Tighten

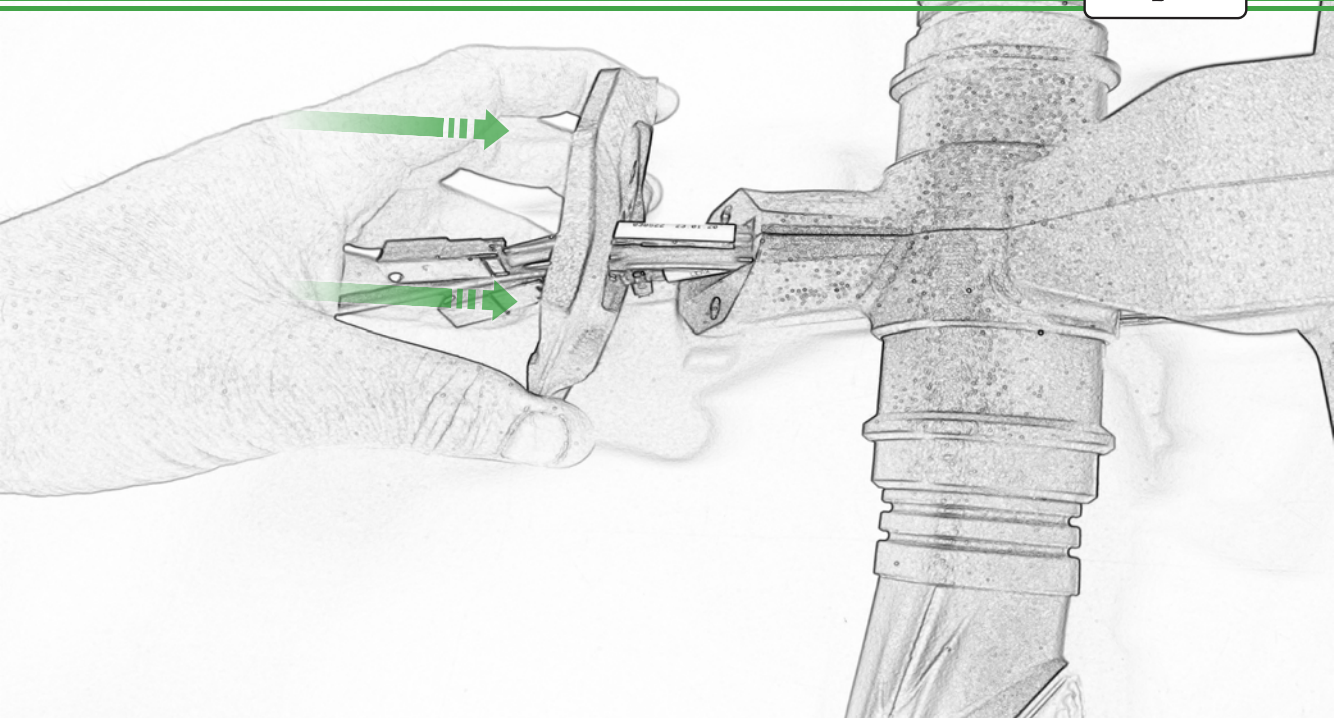

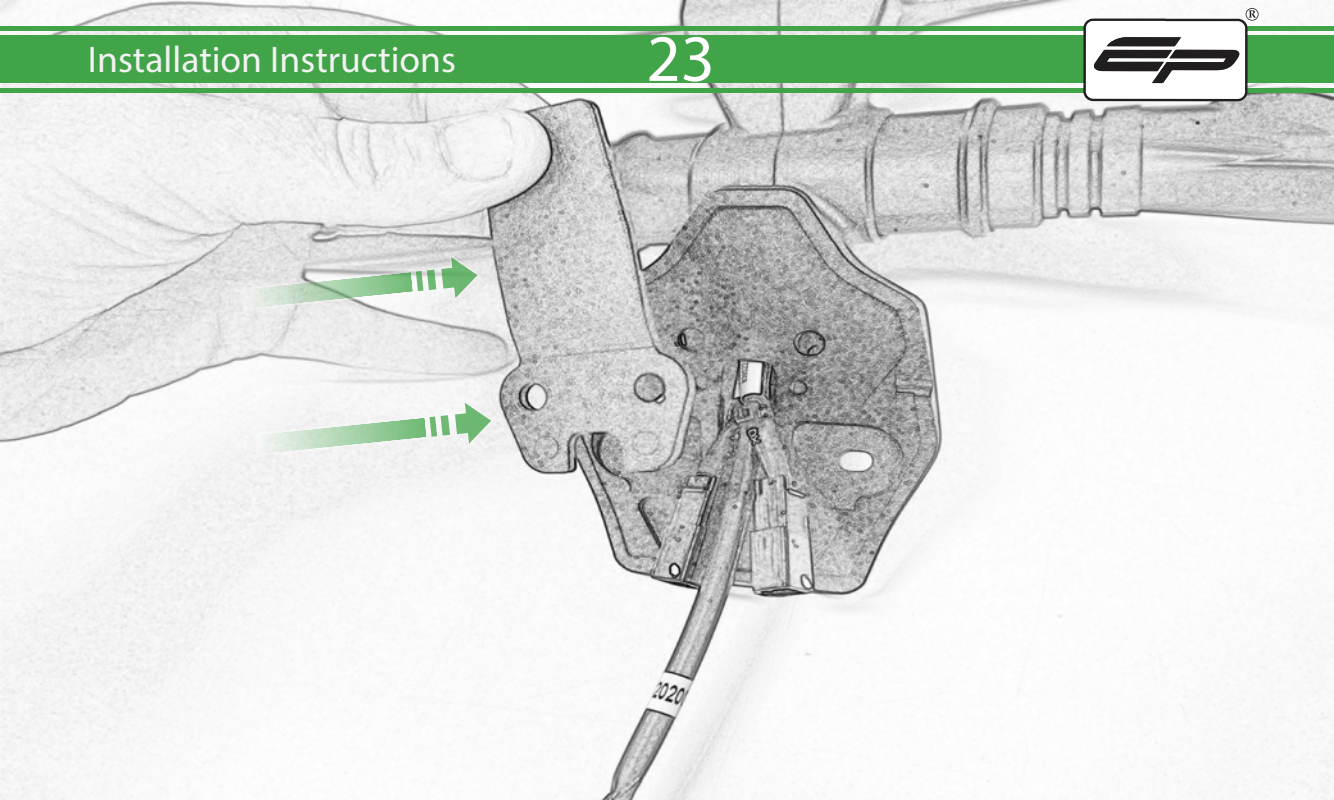



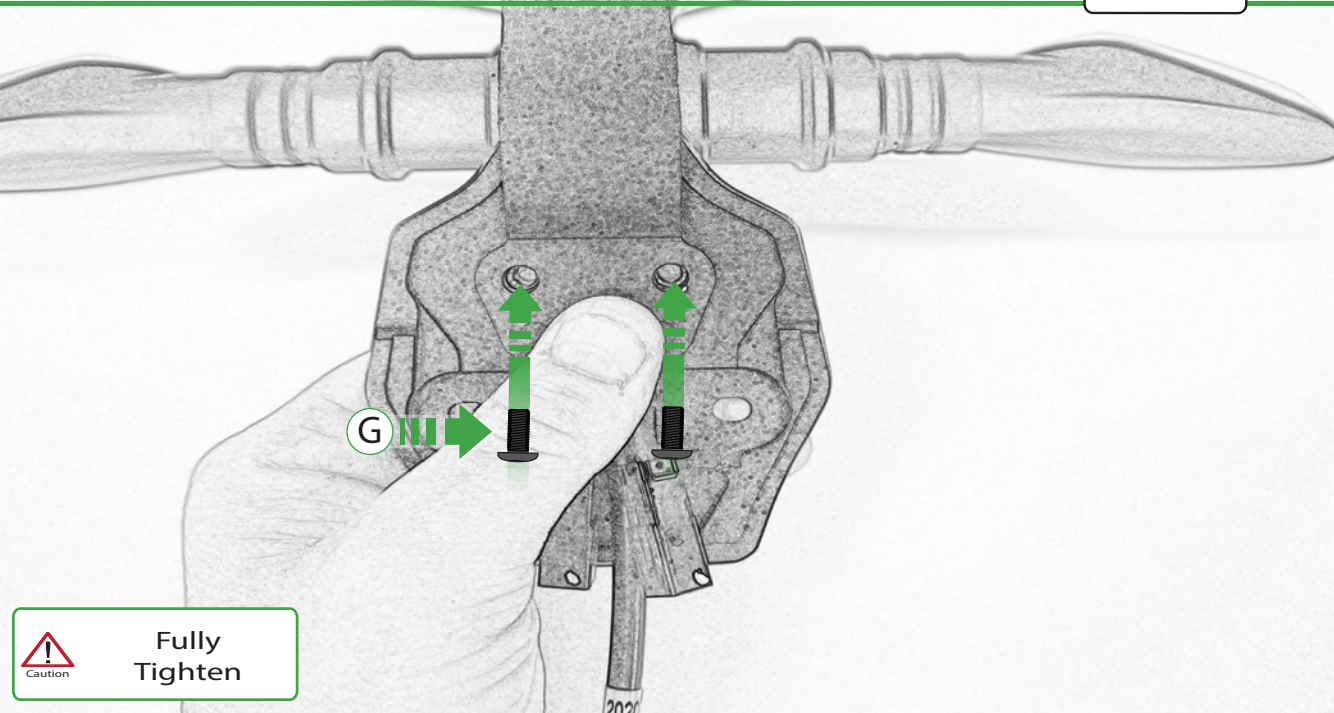

G



Caution

Fully  
Tighten

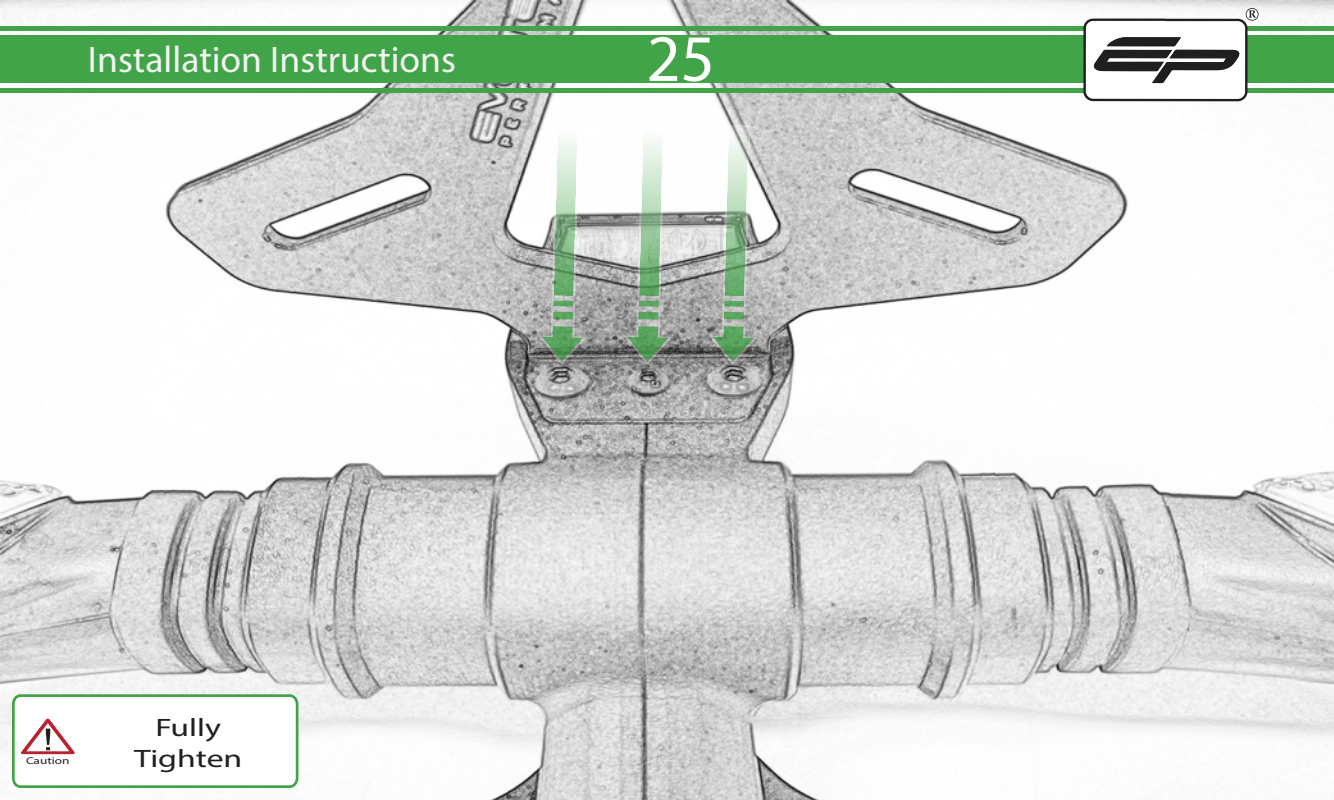

Caution

Fully  
Tighten

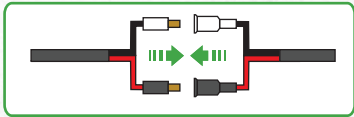
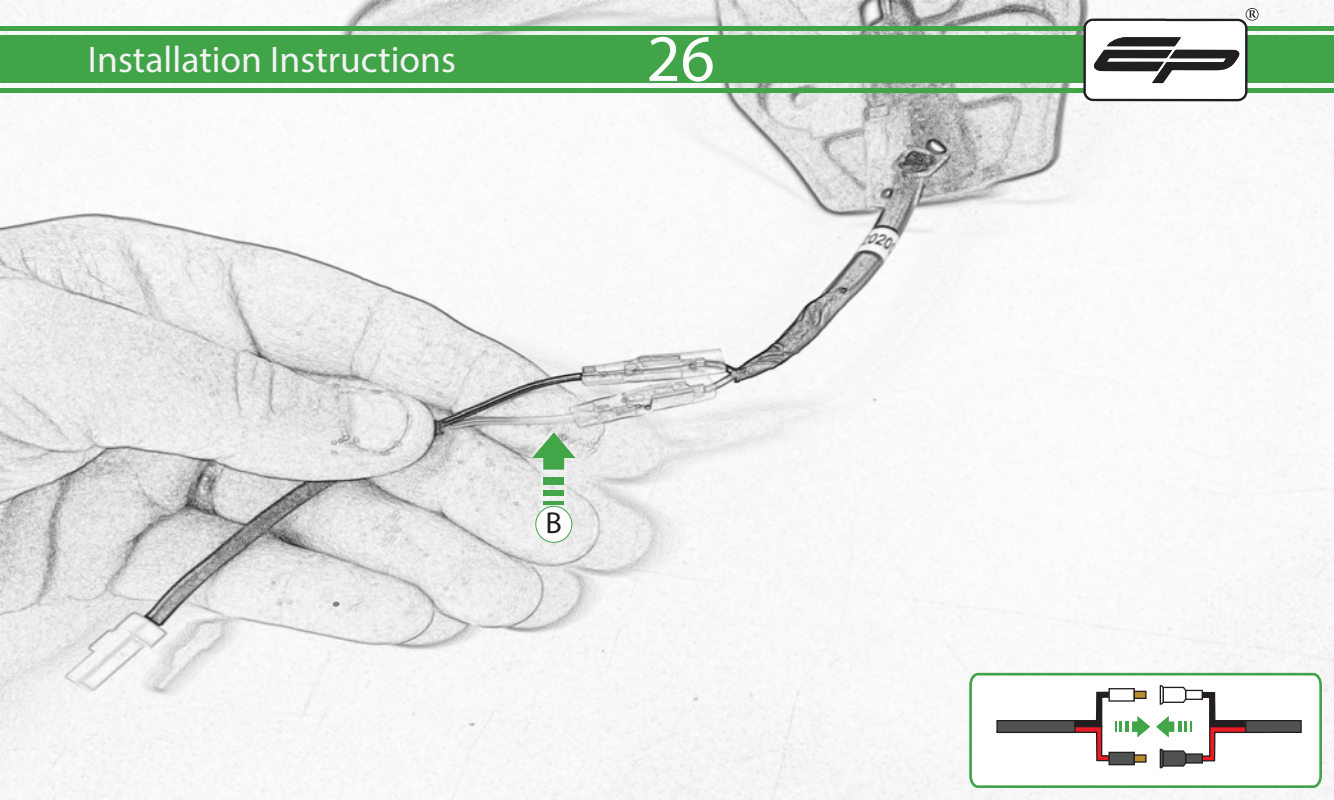

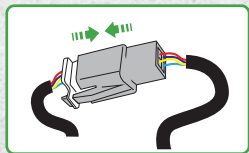
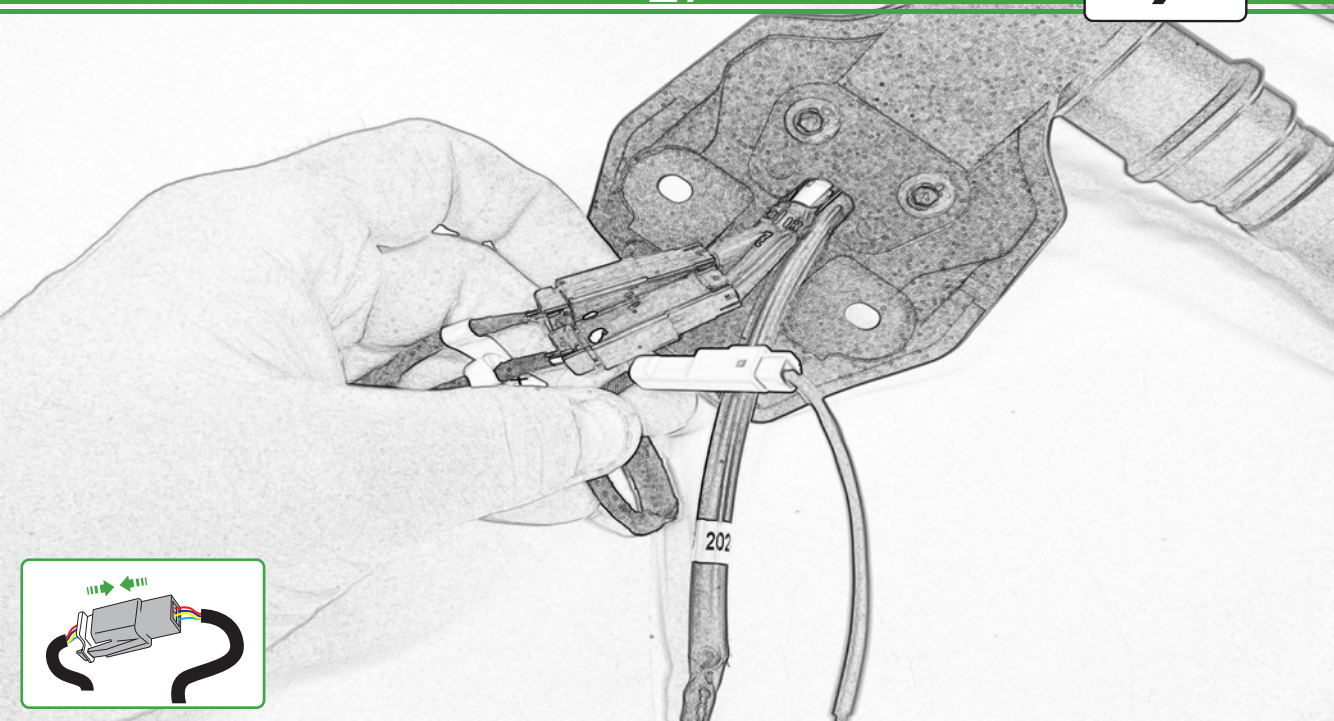

202

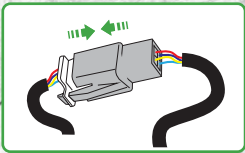
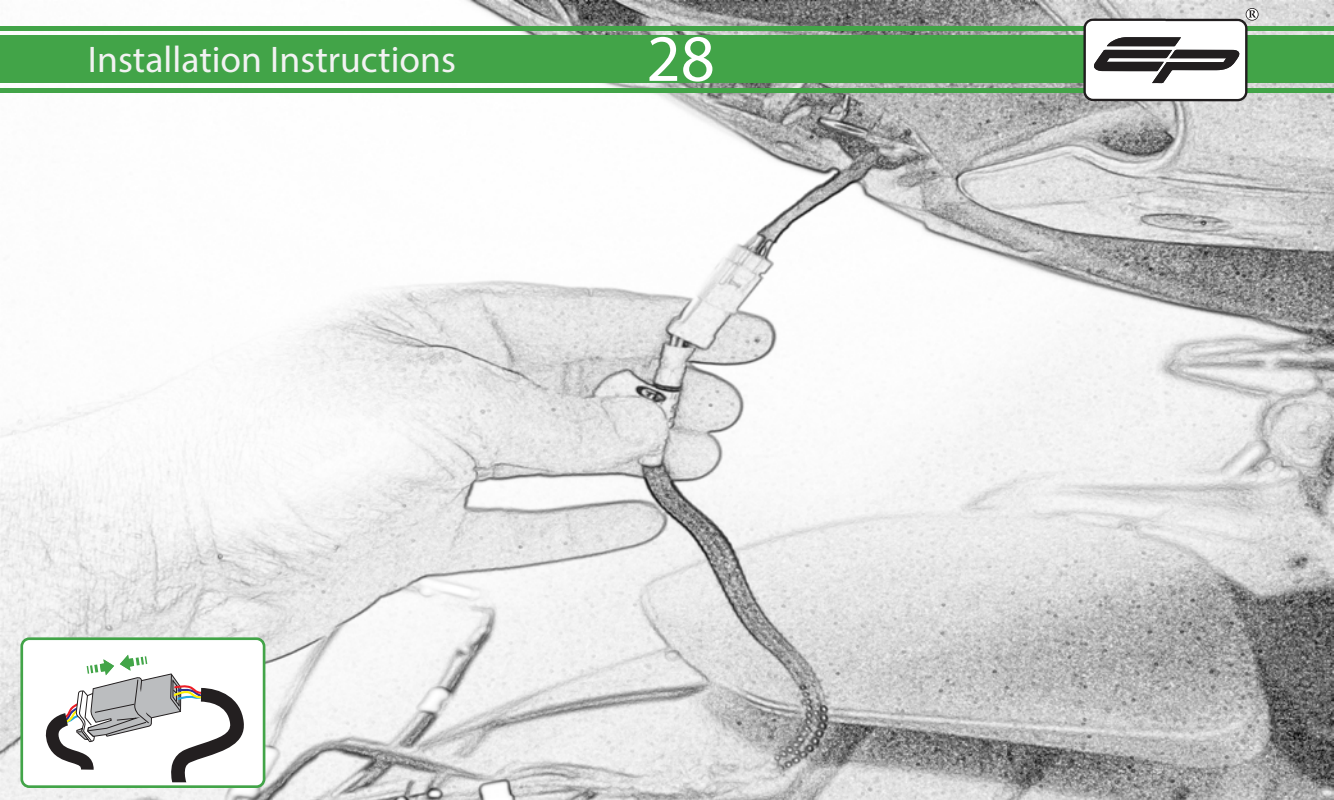

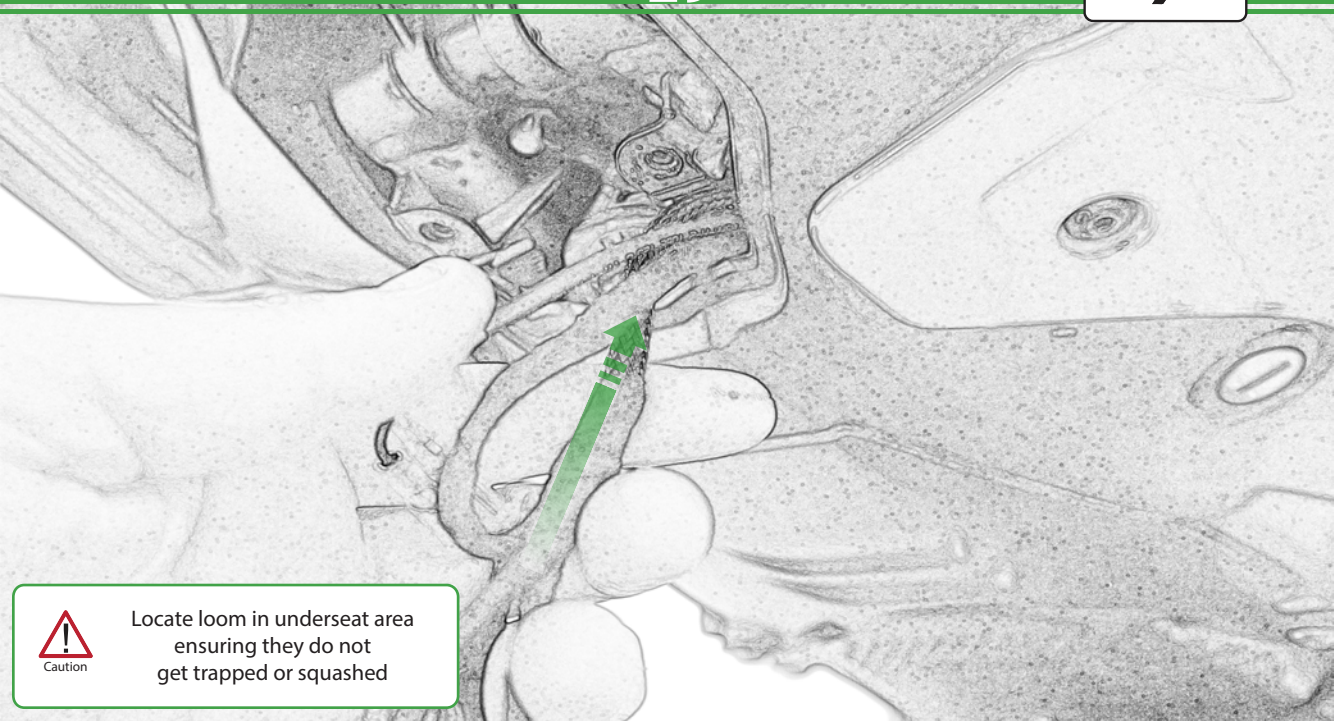

Caution

Locate loom in underseat area  
ensuring they do not  
get trapped or squashed

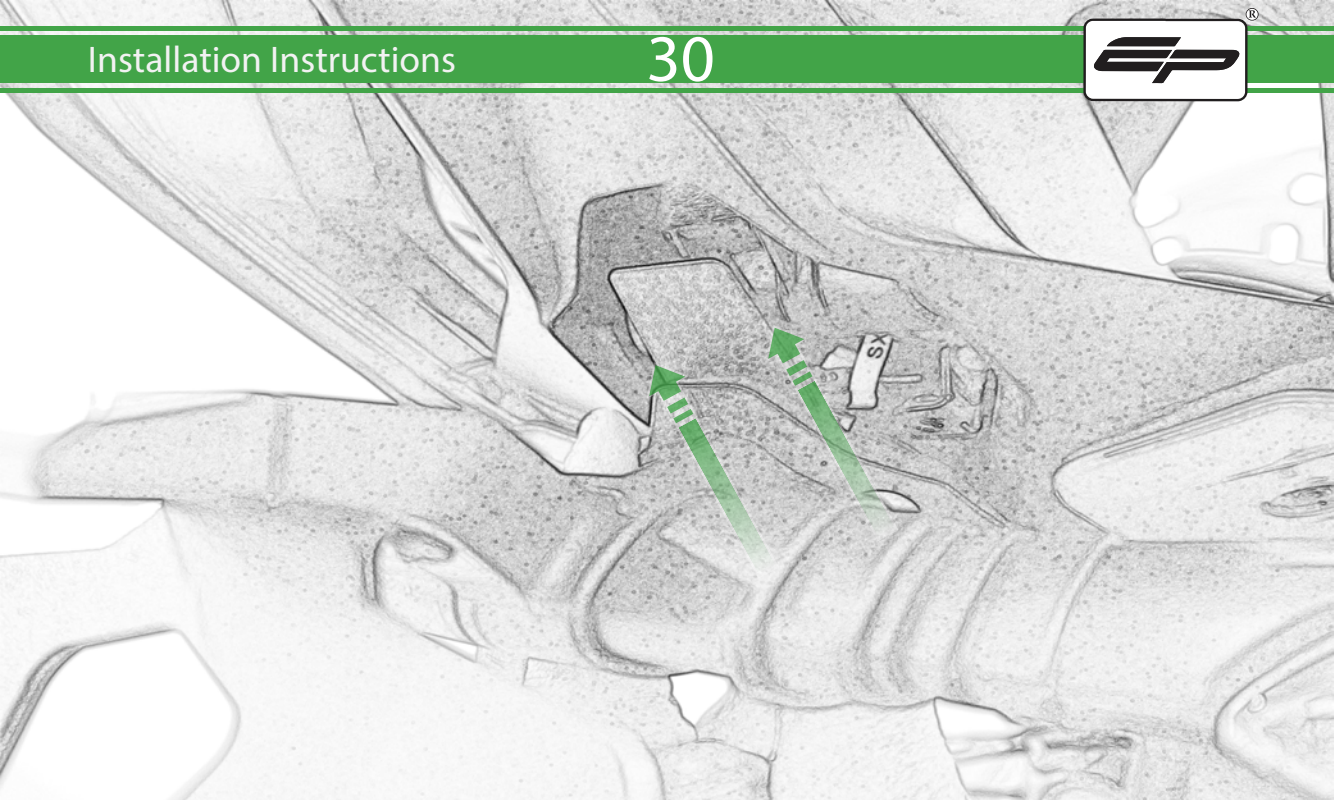

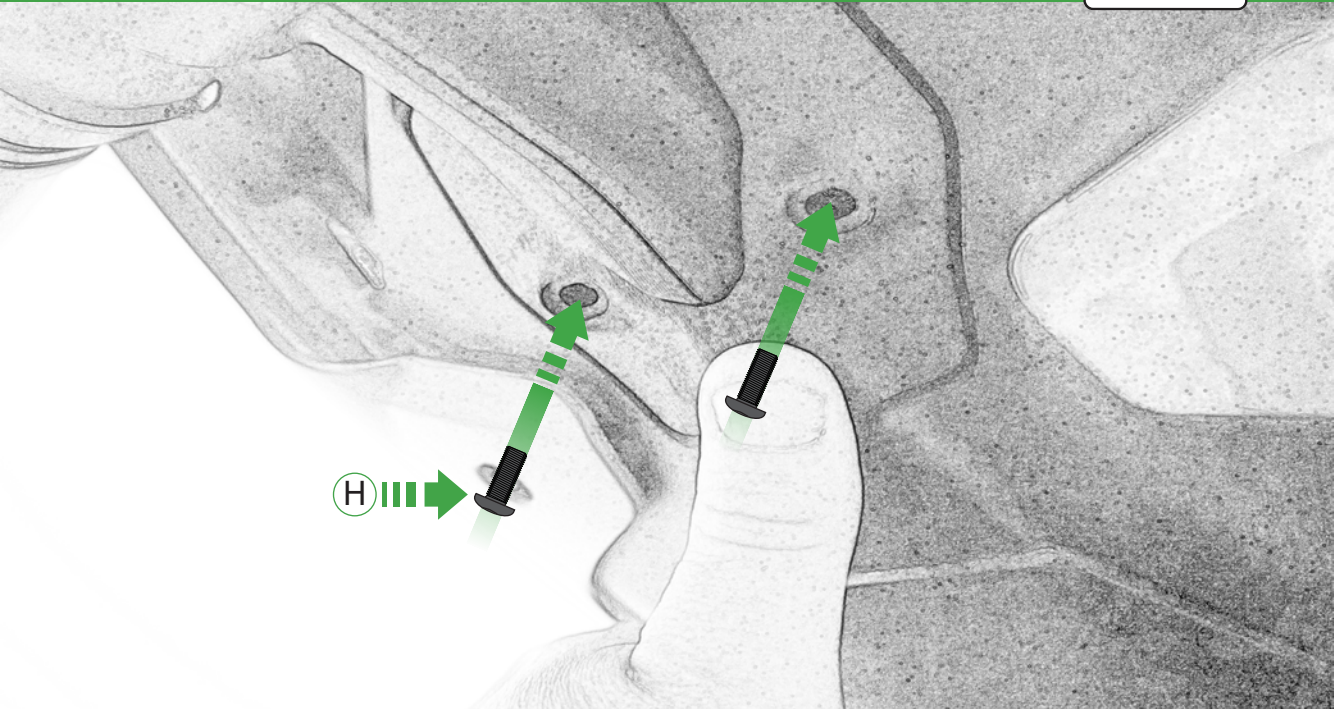

H



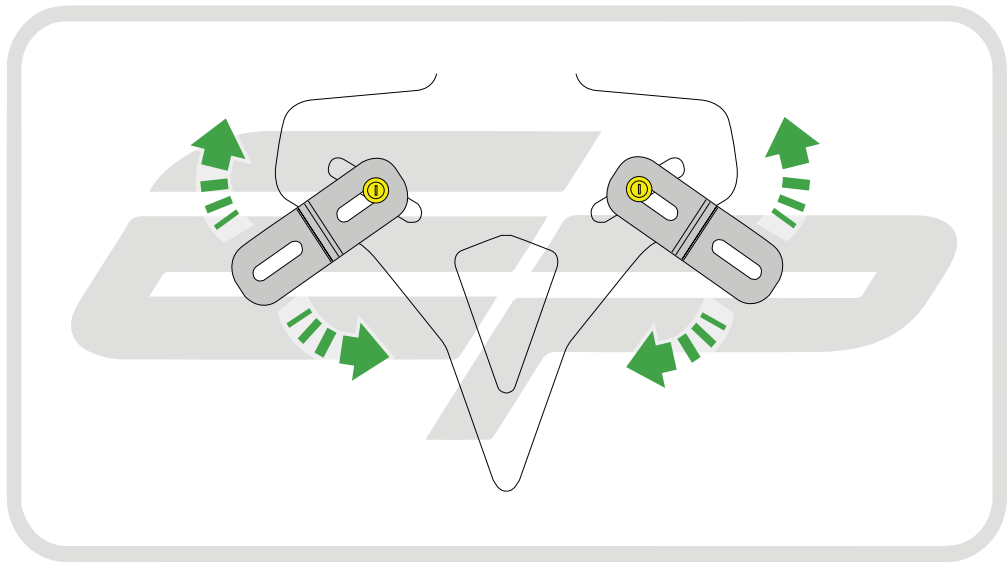

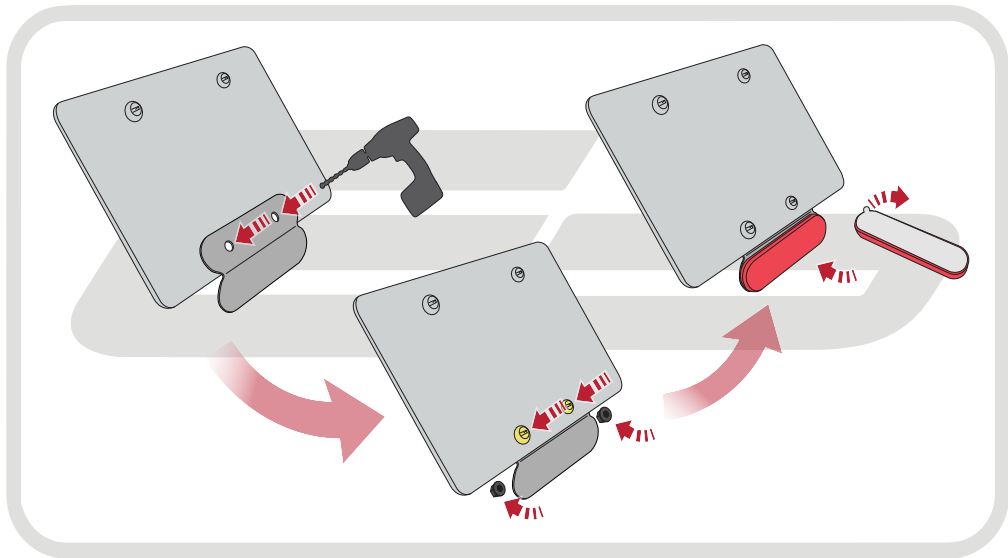

## **ESSENTIAL CHECKS**

After installation of your tail tidy ensure that the licence plate does not contact the rear tyre when suspension is fully compressed.

Ensure all electrics including indicators, tail light, brake light and licence plate light lights are working correctly before riding the motorcycle.

It is recommended that periodic inspections are made to ensure that all fixings are fully tightend.