

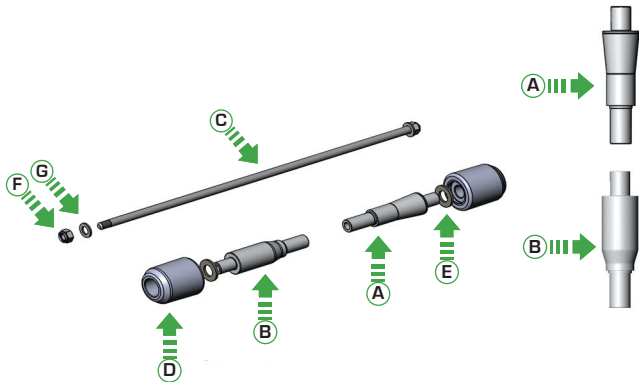

## Kit Contents PRN013903

- A** 1 x L/H Stem
- B** 1 x R/H Stem
- C** 1 x M12 Shaft
- D** 2 x Bobbin Heads
- E** 2 x Polyurethane Washers
- F** 2 x M12 Nuts
- G** 2 x M12 Washers

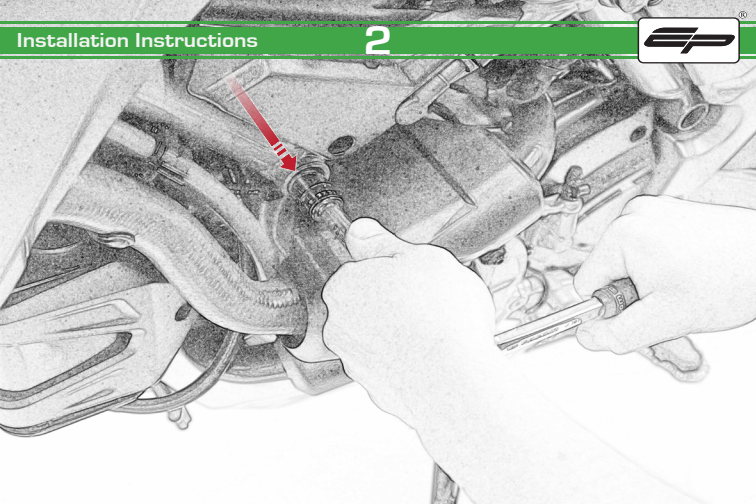



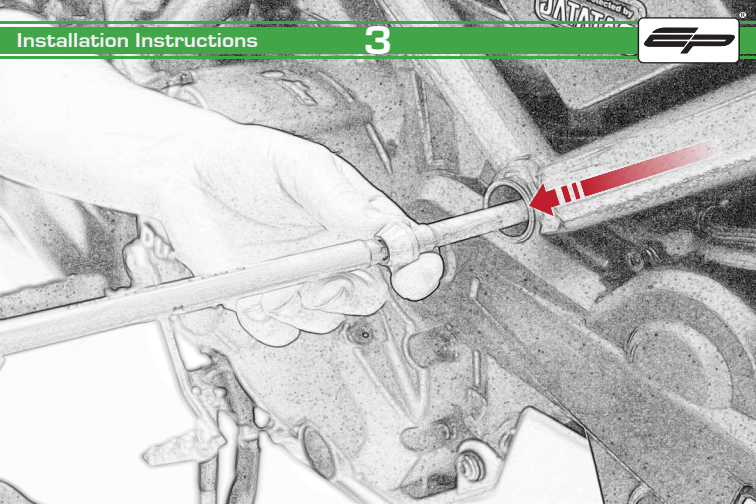

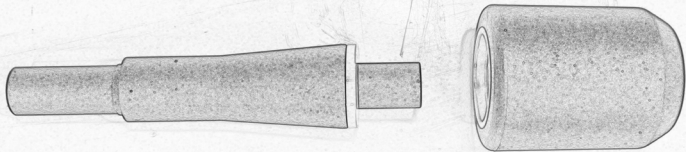

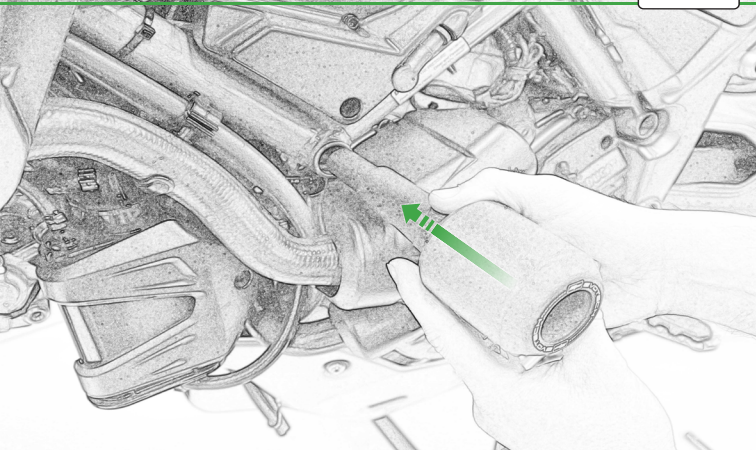

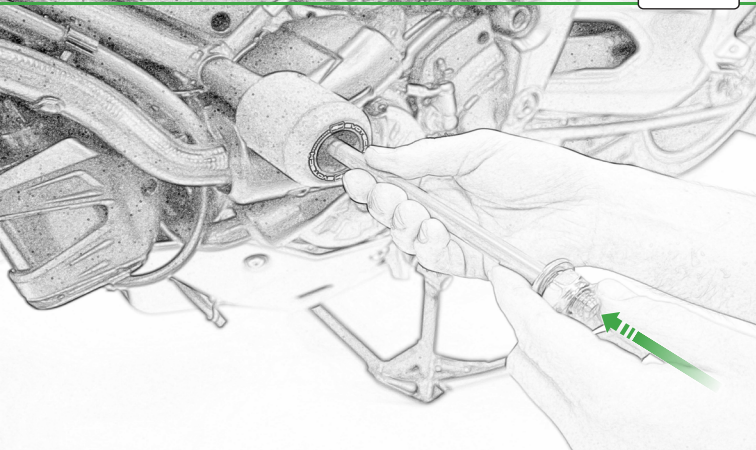

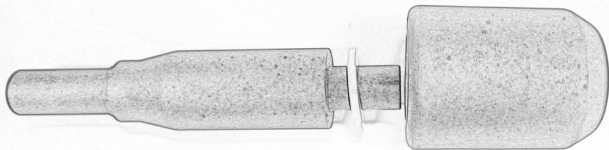



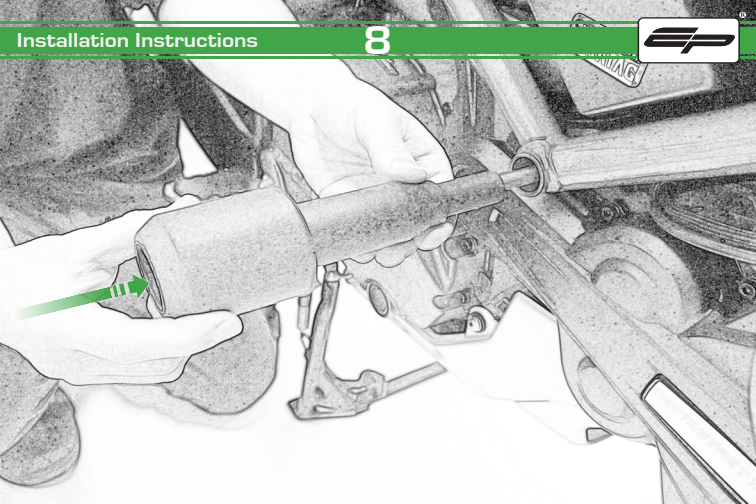

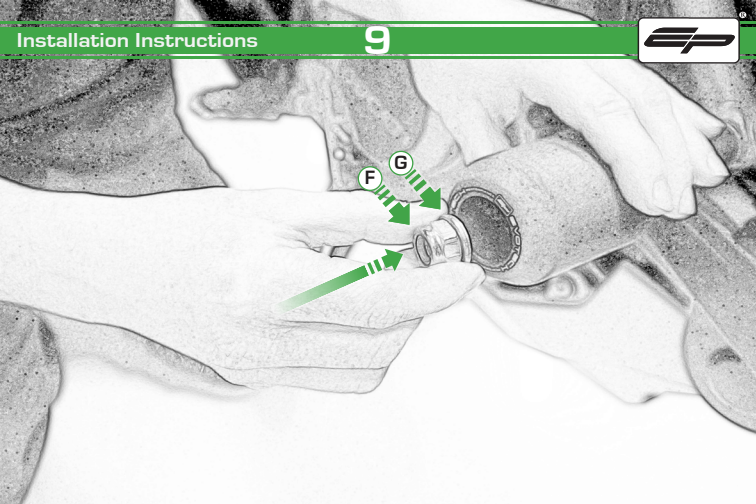

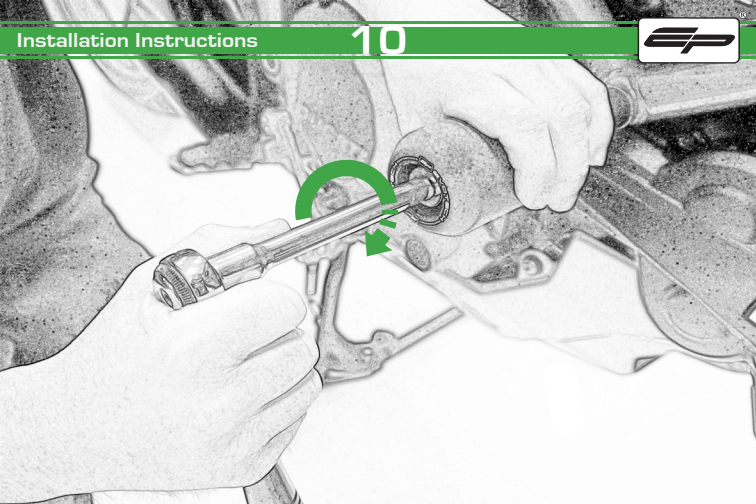



### ESSENTIAL CHECKS

It is recommended that periodic inspections are made to ensure that all bolts are tightened to the specified torque settings.

Should the bike be involved in an accident a thorough inspection should be made and any components that have taken an impact, no matter how small, be replaced