



LCD Display User Manual

MSE-23016 / MST-23016

Please keep this manual for future reference.

www.mimomonitors.com

Mimo Tech Support Phone Number - 855-937-6466

Mimo Tech Support email - techsupport@mimomonitors.com

Table Of Contents

SAFETY INSTRUCTIONS	3
Declarations and Statements	4
WHAT'S IN THE BOX	5
Package Contents.....	5
MOVING THE DISPLAY	6
Unpacking the Display	6
Carrying the Display	8
Placing the Display.....	8
Setting Down the Display	8
MOUNTING THE DISPLAY	9
Orienting the Display	9
Wireless Antenna	10
Wall Mount Specifications	10
SETTING UP THE DISPLAY	11
Main Components.....	11
Connecting the Power Cable	12
CONNECTING THE DISPLAY	13
Using the Micro-USB Port.....	13
Connecting a Second Display	14
Connecting to Wireless Internet	15
Connecting to the Internet via a Wired Connection	16
HOME SCREEN	17
SETTINGS	18
Adjusting the brightness	19
Changing the Display's Language.....	20
Changing the Date and Time	21
INSTALLING APPS	22
PRODUCT SPECIFICATIONS	23

SAFETY INSTRUCTIONS

Please carefully read through and keep the following instructions for future reference before using the display.

- Before using the LCD display, please read this manual completely and follow the guidelines to protect your own and other people's property and avoid causing serious injury.
- DO NOT use this apparatus near water or install in a high-humidity environment.
- DO NOT place this apparatus in direct sunlight or install near any heat sources (such as radiators, heat registers, or stoves).
- DO NOT block any ventilation openings. Always leave a space of at least 10cm around this apparatus. The slots and openings are provided to protect the display from overheating and to help maintain reliable operation of the display.
- NEVER place this apparatus on an unstable cart, stand, bracket, or table. It may cause serious personal injury, death, or serious damage to the display.
- When positioning the display, make sure the power plug and outlet are easily accessible and protect the power cord from being walked on or pinched.
- DO NOT overload the wall outlets and connect too many appliances to the same AC power outlet.
- DO NOT use any unapproved items or cables to connect to this apparatus.
- DO NOT defeat the safety purpose of the polarized or grounding type plug.
- ONLY USE accessories specified by the manufacturer.
- Clean only with a dry cloth and turn the power off before cleaning.
- Keep this apparatus and all package contents (including the EPE foam packaging cushion and protective board) out of the reach of children at all times.
- Never attempt to repair or open the display by yourself. Opening and removing the covers may expose you to dangerous voltage or other hazards. Failure to follow this WARNING may result in death or serious injury. Please contact your dealer or a service technician for assistance.
- Too much screen time may hurt your eyesight. Rest your eyes for 10 minutes after 30 minutes screen time.
- Kids under 2 years old should not watch the screen, and kids over 2 years old should not watch the screen for more than 1 hour per day.



WARNING: If using a Class I adapter, connect only to a grounded electrical outlet.

Consult an authorized service technician if the display does not operate normally when you have followed the instructions in this manual.

Declarations and Statements

CE Class A statement:



EU Declaration of Conformity

We, AU Optronics Corporation, declare that this product complies with the following Directives:

2014/35/EU

2014/53/EU

And the following standards have been applied:

EN 60950-1:2006+A1:2010+A11:2009+A12:2011+A2:2013

EN 62311:2008

EN 300 328 V2.1.1

EN 301 489-1 V2.1.1

EN 301 489-17 V3.1.1

Important:

- This product must not be used in residential areas.
- This product may cause interference if used in residential areas. Such use must be avoided unless the user takes special measures to reduce electromagnetic emissions to prevent interference to the reception of radio and television broadcasts. The frequency and maximum transmitted power in EU are listed as below:
2412 – 2472 MHz: 17.98 dBm

MSIT (Ministry of Science and ICT) Statement

Name of the company: AU Optronics Corporation

Name of equipment (model name): LCD monitor (G229HAF02.0)

Date of manufacture: Month and Year

Manufacturer/Country of origin: AUO / made in China

Services related to personal safety may not apply since radio interference may be caused by the wireless equipment.

This device has been evaluated for business use. If this device is used in home environments, radio interference may occur.

Declaration of the Presence Condition of the Restricted Substances Marking

Equipment Name: LCD Display		Type Designation (Type): G229HAF02.0				
Unit	Restricted substances and its chemical symbols					
	Lead (Pb)	Mercury (Hg)	Cadmium (Cd)	Hexavalent chromium (Cr ⁺⁶)	Polybrominated biphenyls (PBB)	Polybrominated diphenyl ethers (PBDE)
Printed circuit board	—	○	○	○	○	○
Cover	○	○	○	○	○	○
LCD Panel	○	○	○	○	○	○
Power cable	—	○	○	○	○	○
<p>Note 1: "Exceeding 0.1 wt %" and "exceeding 0.01 wt %" indicate that the percentage content of the restricted substance exceeds the reference percentage value of presence condition.</p> <p>Note 2: "○" indicates that the percentage content of the restricted substance does not exceed the percentage of reference value of presence.</p> <p>Note 3: The "—" indicates that the restricted substance corresponds to the exemption.</p> <p>AU Optronics Corporation (AUO) Address: No. 1, Li-Hsin Rd. 2, Hsinchu Science Park, Hsinchu 30078, Taiwan, R.O.C.</p>						

WHAT'S IN THE BOX

Package Contents

Check your product box for the following items. If there are any missing accessories, contact the local dealer where you purchased your display. The illustrations in this manual may differ from the actual product and items.



Display x 6



Adapter x 6



Power Cord x 6



Micro-HDMI Cable x 6



Type-C USB Cable x 6

MOVING THE DISPLAY

Unpacking the Display

Before unpacking the display, prepare a flat and stable surface near a wall outlet. Set the product box in an upright position according to the arrow markings on the outside of the product box.

1. Open the product box from the top side.

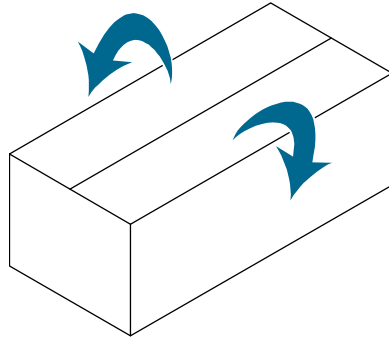

2. Remove the top EPE cushion.

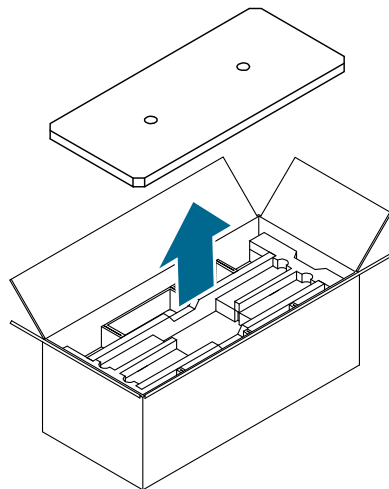

3. Remove two sets of accessories from the side compartments in the top layer.

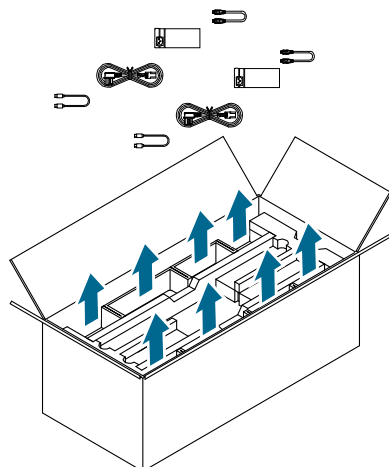

4. Remove two displays, one by one, from the center compartment of the top layer.

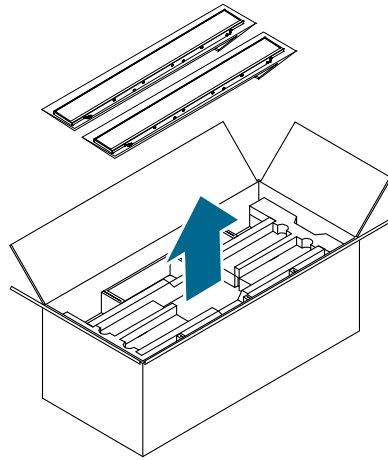

5. Remove the cardboard and EPE foam base of the top layer.

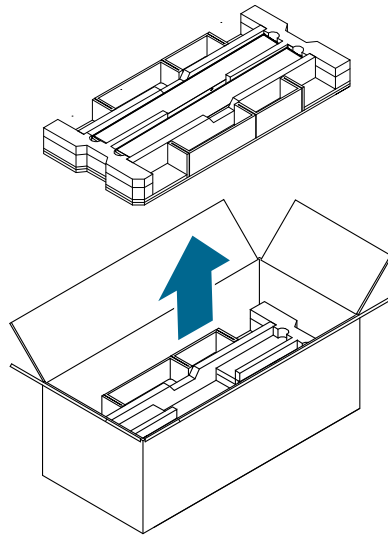

6. Repeat steps 3 to 5 for the second layer.
7. Repeat steps 3 to 4 for the third layer.
8. Remove the electrostatic bags covering each display.

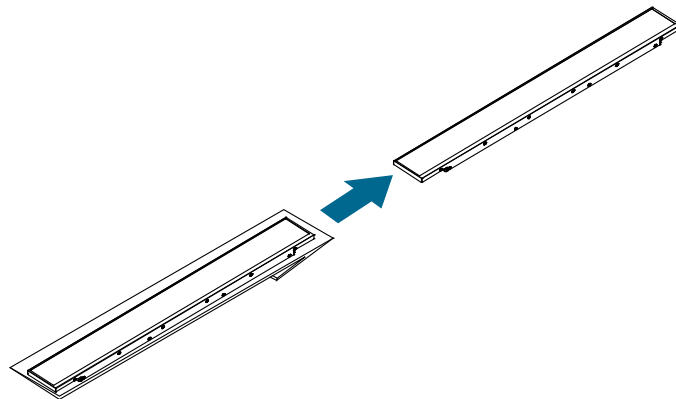

Carrying the Display

When carrying the display, always hold the display securely using both hands. When gripping the display do not put force to the screen.

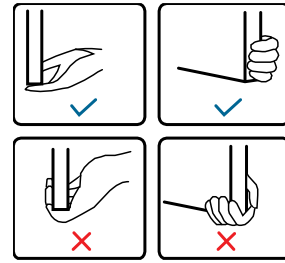

CAUTION: Avoid applying force or using sharp objects on the screen at all times.

Placing the Display

When placing the display, always put the screen face down as illustrated in the Setting Down the Display section. Never stand the display upright. Never tilt the display towards the left, right or balanced on a single corner of the frame.

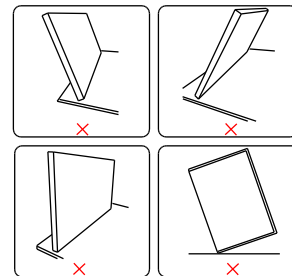

Setting Down the Display

When setting the display down, place the screen face down on a flat and stable surface covered by a protective sheet and a table cushion as shown in the illustration provided.

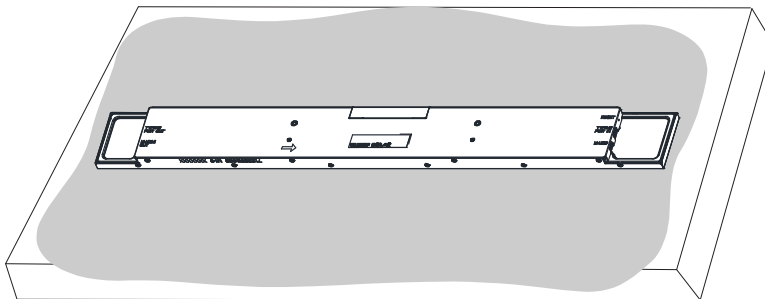

CAUTION: Never press or place anything on the back cover. This may damage the internal parts of the display.

MOUNTING THE DISPLAY

Orienting the Display

To avoid injuries, follow the installation instructions to safely install the display onto a wall. It is recommended to allow a certified installation company conduct the wall mounting operation.



CAUTION: Dropping the display may cause injuries to people around it.



NOTE: A wall mount may be purchased separately for easier installation.

If you want to use the display vertically or horizontally, adjust the display such that the output ports on the back of the display are pointing downward and the input ports are pointing upward (as illustrated below). If the display is not mounted in such a way the display may not function properly.

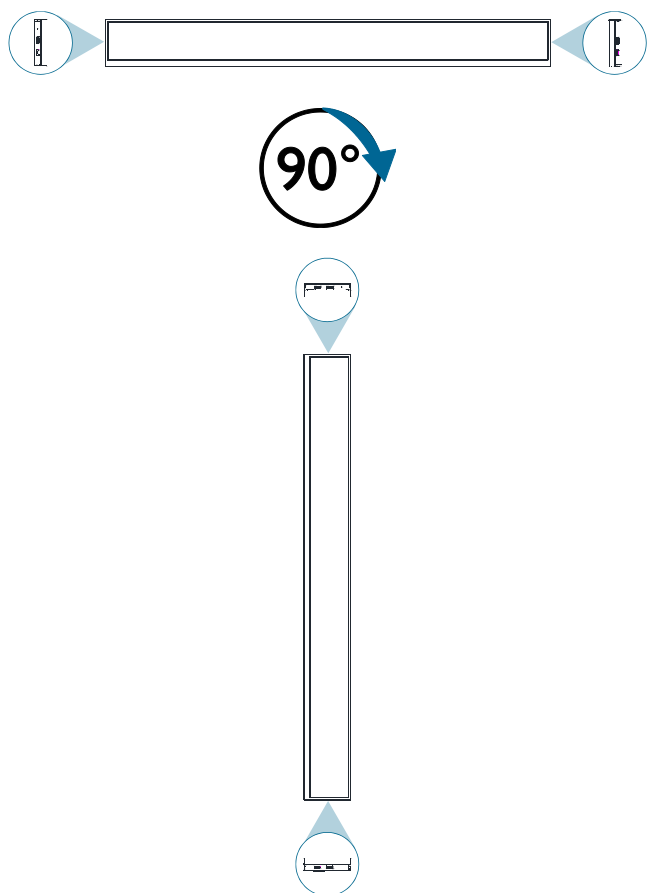

NOTE: Before mounting, make sure there is space to connect your devices. See “CONNECTING THE DISPLAY” on page 13.

Wireless Antenna

The display features an antenna on its top side used for Wi-Fi connections. When installing the display, please ensure that no objects are placed on the wireless antenna and that the area around the antenna is kept clear of any metal objects, devices, or equipment. Failure to do so will result in weak or possibly no wireless signal.

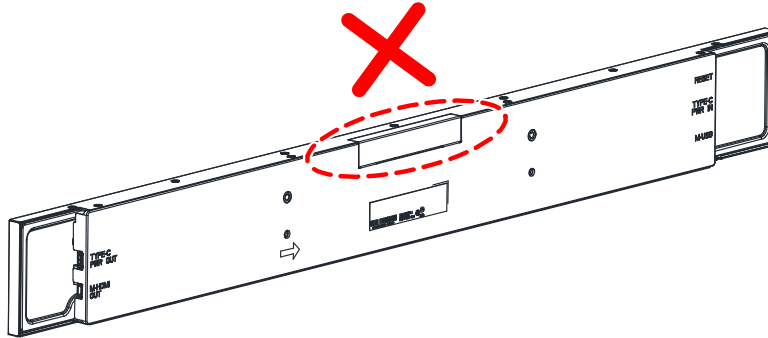

Wall Mount Specifications

The back of the display is equipped with two screw-holes with a width of 190.00mm that allow for mounting. Firmly secure a mount onto the display using two M3x4mm length screws (maximum torque: 8 kgf-cm).

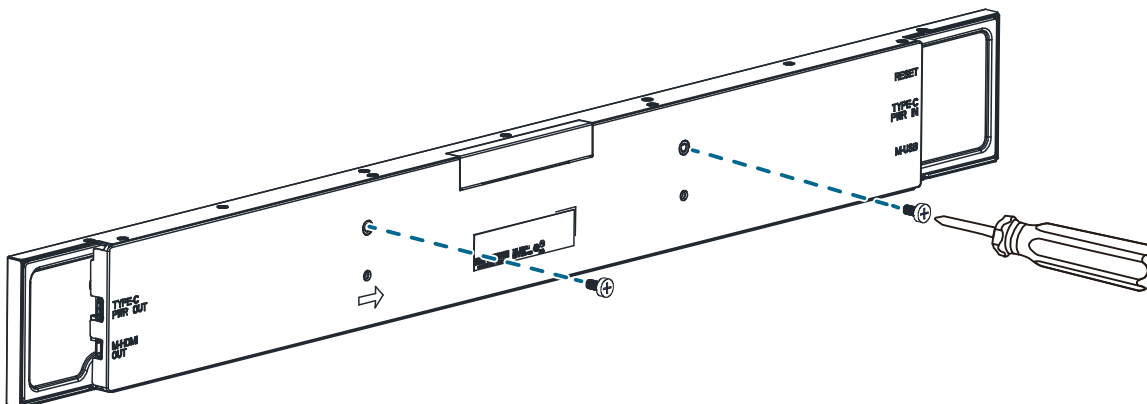
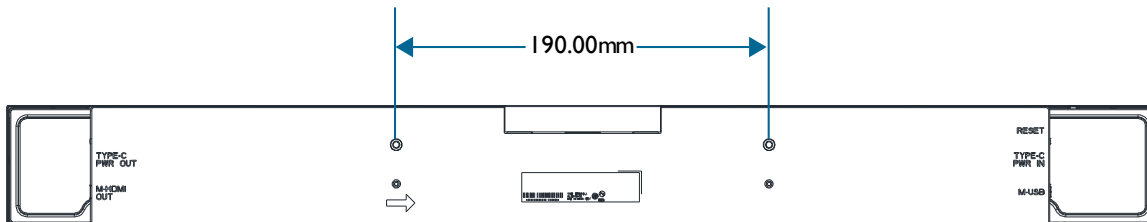

SETTING UP THE DISPLAY

Main Components

The following image and table show the location of the connectors and other components.

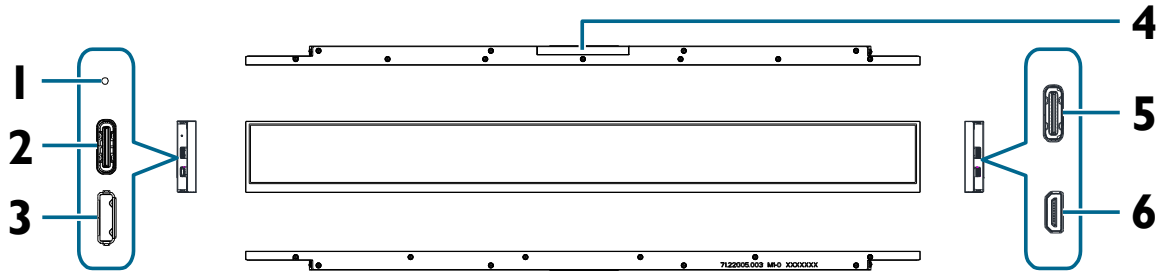

Item	Description
1	RESET button Press with a sharp-tipped instrument to restart the display.
2	TYPE-C PWR IN (Power Input) Connects with the supplied adapter and power cord.
3	M-USB (Micro-USB Input) Connects with storage devices containing video and image files, a mouse, or a keyboard.
4	Wi-Fi Antenna Receives wireless internet signal.
5	TYPE-C PWR OUT (Power Output) Connects with the Type-C power input port of a second bar-type display to provide power to the second display.
6	M-HDMI OUT (Micro-HDMI Output) Connects with the Micro-HDMI input port of a second bar-type display to duplicate the video shown on this display.

Connecting the Power Cable

1. Connect the adapter to the display.
2. Connect the power cord to the adapter.
3. Fully insert the plug the power cord into the power outlet socket.

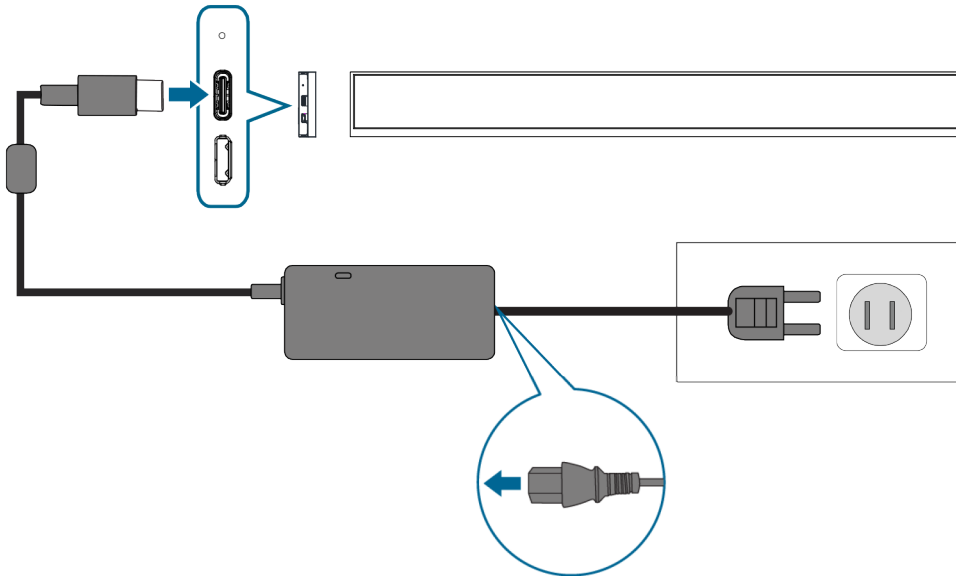

Once the power connection is made, the display will automatically power on.



CAUTION: Loose connections may cause noise. Do not plug and unplug the power cord repeatedly in a short period of time.



NOTE:

- The supplied power cord varies depending on the country where you purchased this apparatus. For all cases, use a power cord that matches the AC voltage of the power outlet and has been approved by and complies with the safety standard of your country.
- Be sure use applicable AC/DC adapter:
Manufacture WEIHAI Power Electronics Co., Ltd. Model:AMB-036-12



CAUTION: When disconnecting the AC power cord, be sure to first disconnect the plug from the outlet socket.

CONNECTING THE DISPLAY



NOTE: Before making connections, make sure that the power for all the connected equipment is off and then powering on each device including the display after the connections are made.

Using the Micro-USB Port

1. Connect a USB-to-Micro-USB adapter or hub to the M-USB input port on display:
2. Connect any of the following items to the USB-to-Micro-USB adapter or hub:
 - USB flash drive, keyboard, or mouse.



NOTE: A customized media player must be installed on the display for the video/image file to display automatically.

- Ethernet hub via an RJ45 cable and an RJ45-to-USB adapter.

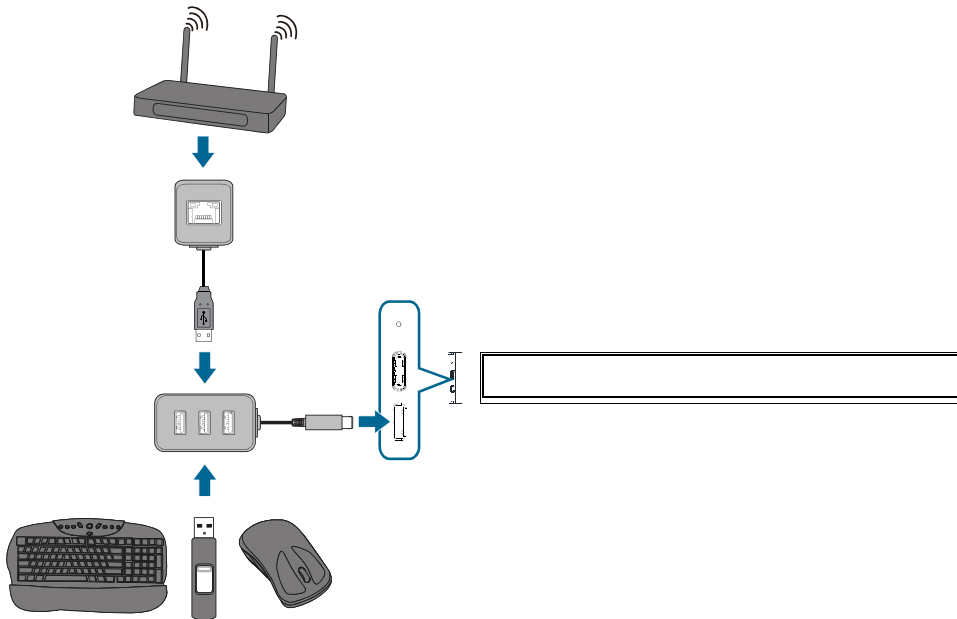

NOTE: The display only supports the following video/image file formats (with their listed resolution) via the Micro-USB port:

- MP4 (H.264/AVC) - 1920x165
- JPG - 1920x165
- BMP - 1920x165

Connecting a Second Display

1. Connect the supplied Type-C USB cable to the Type-C power output port on the display.
2. Connect the supplied Micro-HDMI cable to the Micro-HDMI output port on the display.
3. Connect the Type-C USB cable to the Type-C power input port on the second display.
4. Connect the Micro-HDMI cable to the Micro-HDMI input port on the second display. The second display will begin duplicating the video shown on the primary display.

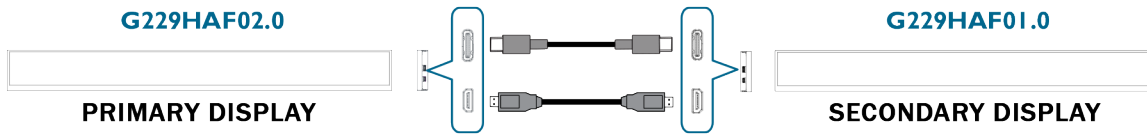

5. Connect a mouse to the display. For connection details, see “Using the Micro-USB Port” on page 13.

By default your display will automatically output its video to the second display, but in instances where the display’s settings have been changed, video output may be disabled. To re-enable video output to a second display follow the instructions below:

1. Power on primary display, see “Connecting the Power Cable” on page 12.
2. Click the All Apps button (arrow icon) at the bottom corner of the home screen to enter the All Apps menu.



3. Select **Settings** in the All Apps screen.

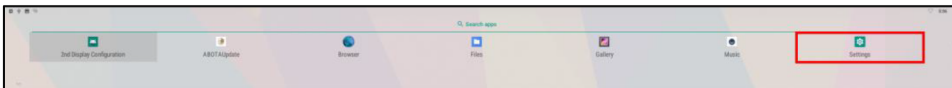

4. Select **Display** in the **Settings** menu.



5. Select **Advanced** in the **Display** menu.

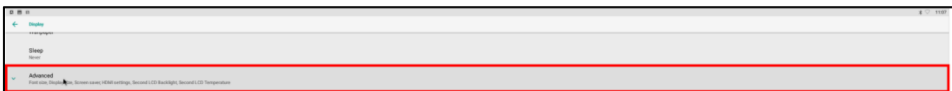

6. Select **HDMI settings** in the **Display** menu.

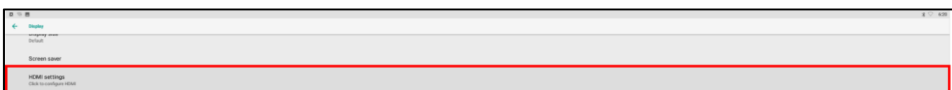

7. Enable **HDMI** in the **Advanced** menu.

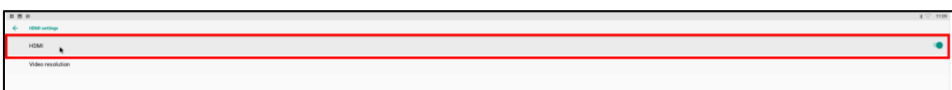

Mimo Monitors

info@mimomonitors.com

Sales: 1-855-YES-MIMO (937-6466)

Connecting to Wireless Internet

After powering on the display you must follow the steps below to connect the display to a wireless router:

1. Connect a mouse to the display. For connection details, see “Using the Micro-USB Port” on page 13.
2. Click the All Apps button (arrow icon) at the bottom corner of the home screen to enter the All Apps menu.



3. Select **Settings** in the All Apps screen.

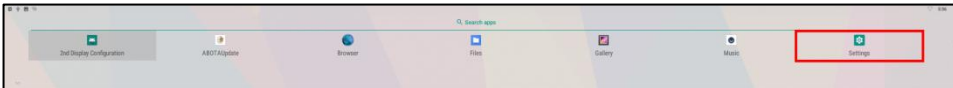

4. Select **Network & Internet** in the **Settings** menu.



5. Select **Wi-Fi** in the **Network & Internet** menu.

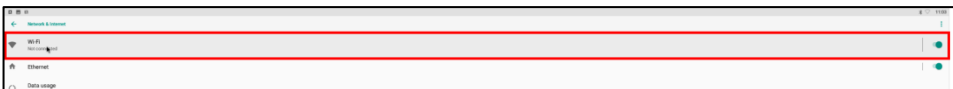

6. Ensure that the **Wi-Fi** switch is enabled.

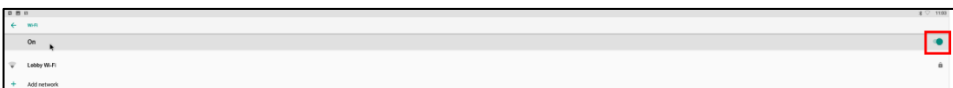

7. Select the SSID of the router you want to connect to. Enter the router’s password if necessary.

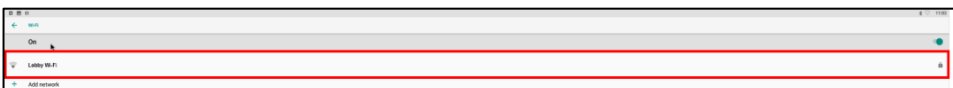

8. Return to the All Apps menu.

9. Select the **Browser** app in the All Apps menu and open a webpage to ensure that you have properly connected to wireless Internet.



Connecting to the Internet via a Wired Connection

The display features a built-in wireless antenna which allows it to wirelessly connect to the Internet. If you need to connect the display to a wired Internet connection you must follow the steps below after powering on the display to connect the display to a router:



NOTE: It is not recommended to simultaneously connect the display to the Internet via both a wireless and a wired connection. You should disconnect your display from any wireless Internet connections first if you choose to connect the display to a wired Internet connection.

1. Connect a mouse to the display. For connection details, see “Using the Micro-USB Port” on page 13.
2. Connect a router to the display. For connection details, see “Using the Micro-USB Port” on page 13.
3. Click the All Apps button (arrow icon) at the bottom corner of the home screen to enter the All Apps menu.



4. Select **Settings** in the All Apps screen.

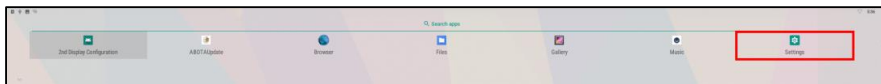

5. Select **Network & Internet** in the **Settings** menu.

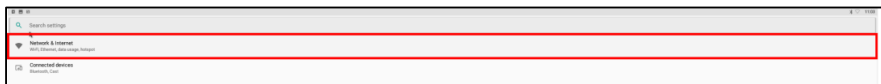

6. Select **Ethernet** in the **Network & Internet** menu.

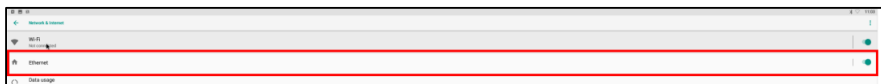

7. Ensure that the switch in the **Ethernet** menu is **On**.



8. Return to the All Apps menu.
9. Select the **Browser** app in the All Apps menu and open a webpage to ensure that you have properly connected to wireless Internet.

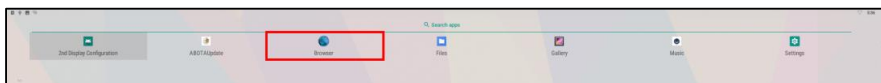

HOME SCREEN

The home screen for the display features multiple buttons that allow you to navigate to apps and settings menus.



SETTINGS

You can adjust a number of the display's settings by using the settings menu for the display. To access the settings menu:

1. Connect a mouse and keyboard to the display. For connection details, see “Using the Micro-USB Port” on page 13.
2. Click the All Apps button (arrow icon) at the bottom corner of the home screen to enter the All Apps menu.



3. Select **Settings** in the All Apps screen.

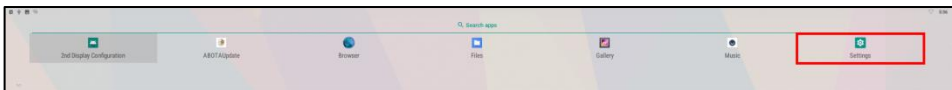

From the settings you can:

- Adjust the brightness of the display
- Change the display's language
- Change the date and time for the display

Adjusting the brightness

To adjust the brightness of the display from the settings menu:

1. Select **Display** in the **Settings** menu.

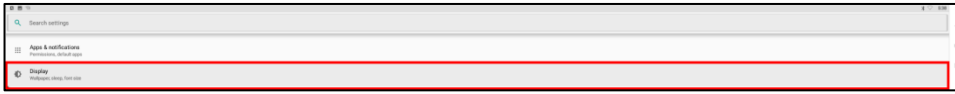

2. Select **Brightness level** in the **Display** menu.

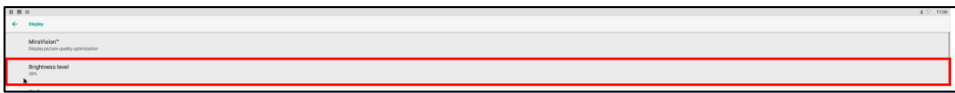

3. Toggle the bar to adjust the brightness to the level you want.

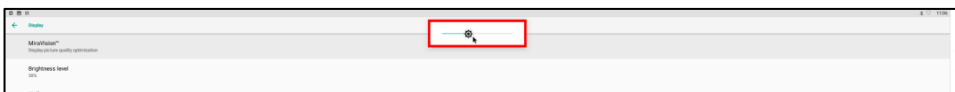

Adjusting the Brightness on a Second Display

If you have connected a second display (as described in the “Connecting a Second Display” section on page 14) you can adjust the brightness on the second display by following the steps below:

1. Return to the All Apps menu.
2. Select **2nd Display Configuration** in the All Apps menu.

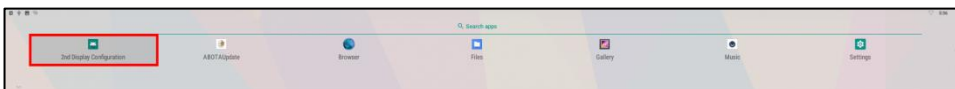

3. Toggle the bar at the top of the **2nd Display Configuration** menu to adjust the brightness to the level you want.



Changing the Display's Language

To change the language of the display from the settings menu:

1. Select **System** in the **Settings** menu.

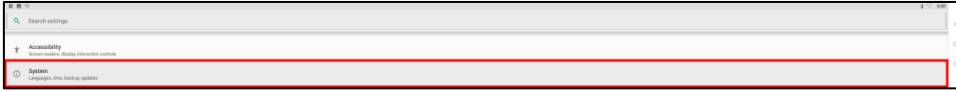

2. Select **Languages & input** in the **System** menu.

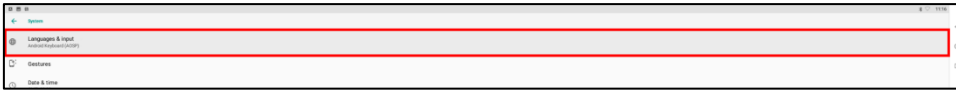

3. Select **Languages** in the **Languages & input** menu.

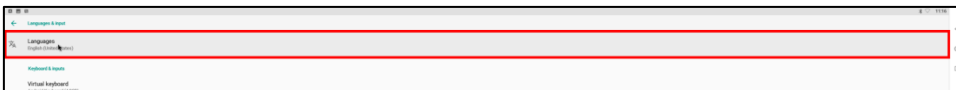

4. Choose either one of the following:

- Right-click on the bar icon on the right of the menu and drag the language you want to set for the display to the top (so that it is listed as number 1) from the list of default languages that appear in the **Languages** menu.



- Select **Add a language** in the **Languages** menu, select the language you want to set for the display from the list of available languages, and then right-click on the bar icon on the right of the menu to drag that language to the top (so that it is listed as number 1).

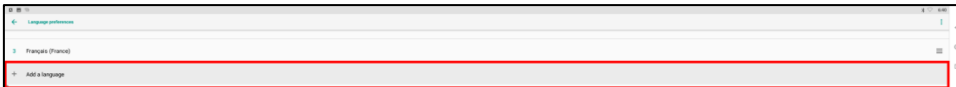

Changing the Date and Time

To change the date and time for the display:

1. Select **System** in the **Settings** menu.

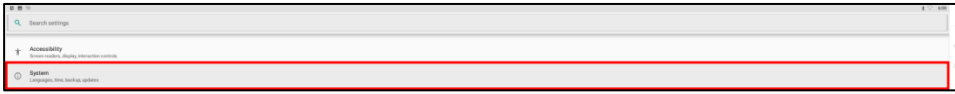

2. Select **Date & time** in the **System** menu.

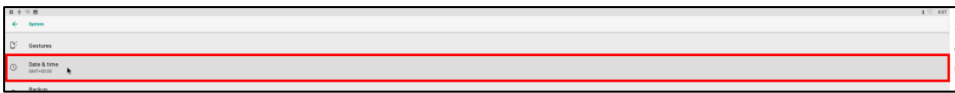

By default the display is configured to automatically set its date and time via the network it is connected to, but in instances where the display's date and time have been changed it may be necessary to re-enable the automatic date and time setting or manually change the date and time.

To re-enable the automatic date and time setting:

1. Ensure that your display is connected to a network (wireless or wired) that has access to the Internet before enabling automatic date and time.
2. Ensure that the **Automatic date & time** setting is enabled in the **Date & time** menu.

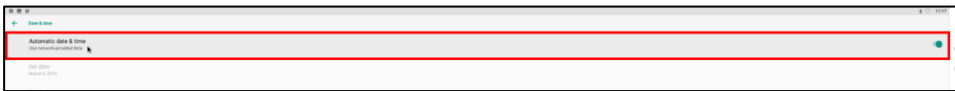

3. Select **Select time zone** in the **Date & time** menu and then select the time zone for the display in the list of time zones that appear.

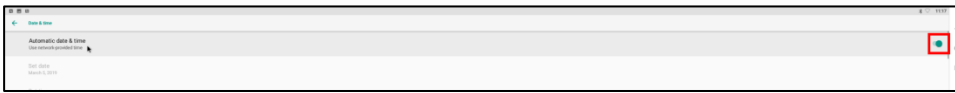

To manually change the date and time:

1. Disable **Automatic date & time** in the **Date & time** menu.



2. Select **Set date** in the **Date & time** menu, and then manually set the date.
3. Select **Set time** in the **Date & time** menu, and then manually set the time.



INSTALLING APPS

To install apps on the display:

1. Connect a USB flash drive containing the app installation file to the display. For connection details, see “Using the Micro-USB Port” on page 13.
2. Connect a mouse to the display. For connection details, see “Using the Micro-USB Port” on page 13.
3. Click the All Apps button (arrow icon) at the bottom corner of the home screen to enter the All Apps menu.



4. Select **Files** in the All Apps menu.

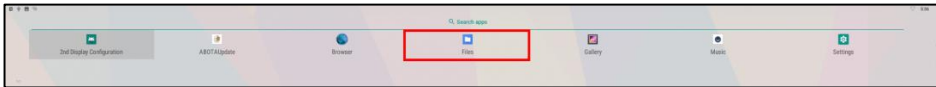

5. Click the menu button at the top-left of the **Files** menu.

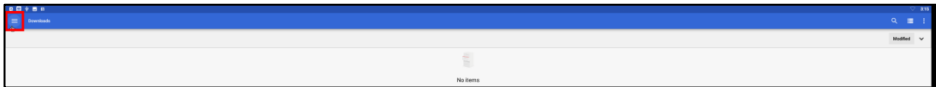

6. Scroll down and select the USB flash drive from the list of file paths.



7. Navigate to the location in the flash drive where the app installation file is located and select the file.

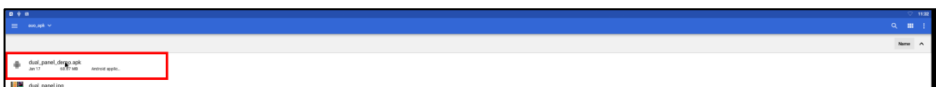

8. Select **CONTINUE** in the warning message that appears.

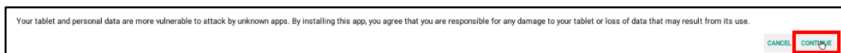

9. Select **INSTALL** in the confirmation message that appears. The app will begin installing.

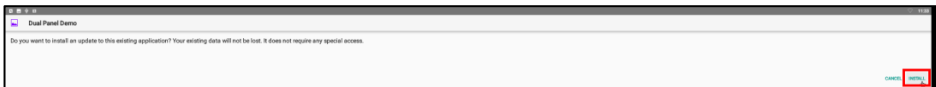

10. Once the app has finished installing an App Installed message will appear. You can choose to open the app by selecting **OPEN**.



PRODUCT SPECIFICATIONS

Item	Model	G229HAF02.0
LCD Panel		
LCD Size (inch)		22.9
Resolution		1920(H) x 165(V)
Brightness (cd/m2)		700
Contrast Ratio		1000 : 1
Response Time (ms)		25 (Tr + Tf)
Frame Rate (Hz)		60
Viewing Angle U/D/L/R (degree)		89 / 89 / 89 / 89
LED Lifetime (hrs)		50,000 (min.)
Surface Treatment		Anti-Glare type, 3H, Haze 25%
Color Gamut		72% NTSC
Color Depths		16.7M (8bit)
Power		
Power Supply		AC 100-240V, 1.2A, 50-60Hz
Power Consumption (W)		15
Display		
System		ARM® Cortex™- A35 Quad - core 1.3GHz 1GB DDR3, 8GB eMMC
Signal Input		-
Signal Output		Micro HDMI x 1
Wireless		WIFI 802.11 b/g/n
Dimension L x W x D (mm)		587.08 x 62.05 x 16.5
Weight (g)		700
Wall Mounting		M3 *4mm / Pitch 190mm
Environment		
Operation Temperature		0°C - 50°C
Storage Temperature		-20°C - 60°C
Operating Humidity		5% - 80% RH
Storage Humidity		5% - 80% RH

Mimo Monitors
743 Alexander Rd. Suite 15
Princeton, NJ 08540

info@mimomonitors.com

Sales: 1-855-YES-MIMO (937-6466)