

The Blind Insert for the WISY WFF 150 Vortex Filter is the only insert made to restrict 100% of the rainwater from to the storage tank. The Blind Insert is the same size as the Filter Insert and is installed by removing the filter mechanism and inserting the blind insert. The Blind Insert is made from stainless steel will not allow any rainwater to flow to the storage tank. When the Blind Insert is installed all collected rainwater is directed to the overflow of the WISY WFF 150 Filter Housing while restricting any water from entering the storage tank.

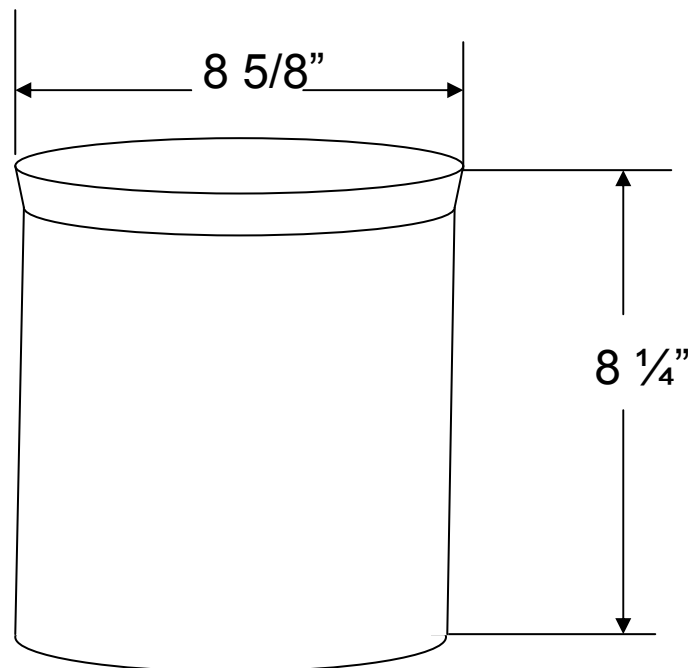

The device is used in harsh winter conditions when the tank is emptied to prevent freezing. The device can also be used to ensure rainwater is not sent to the storage tank during periods of maintenance in the storage tank. More importantly the blind insert can be used to protect the water that is currently stored in the storage tank should airborne contaminants become present. By installing the blind insert, no contaminated water from a natural or manmade disaster will contaminate the water you are already storing.