



**CONTROLLED**

# RHINO-RACK

## Rhino Rack Bow Strap Bonnet Tie Down (RBAS1)

**Important:** Please read these instructions carefully prior to installation. Please refer to your fitting instruction to ensure that the bike rack is installed in the correct locations. Check the contents of kit before commencing fitment and report any discrepancies. Place these instructions in the vehicle's glove box after installation is complete.

### Layout

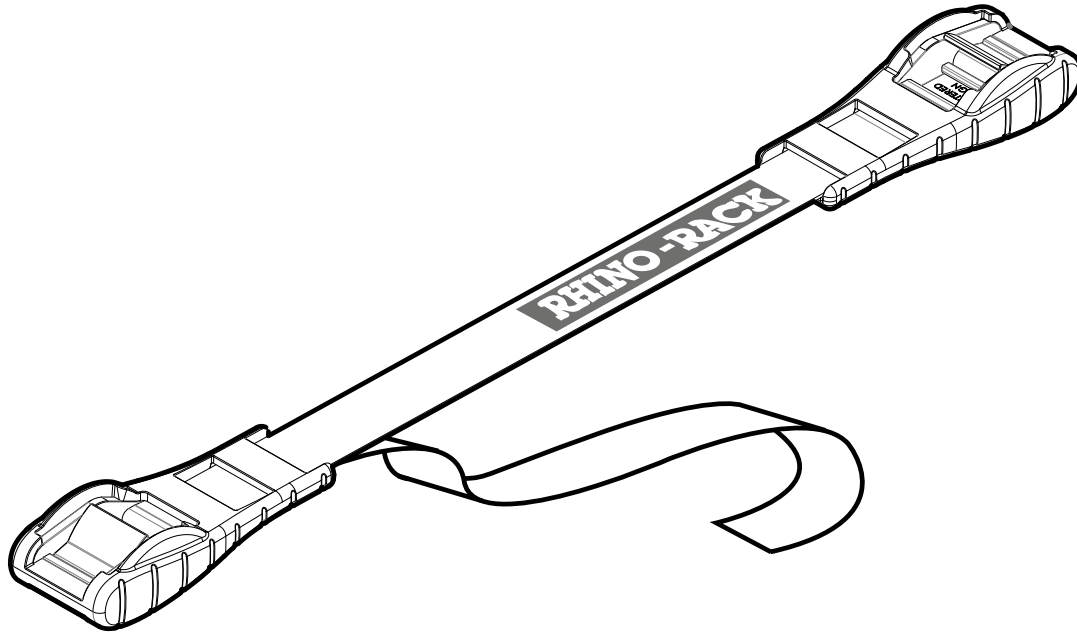

### Parts List

Parts List			
1	Anchor Strap	1	RBAS1
2	Kayak Tie Down	1	
3	Instructions	1	R333

**Speed Rating:** Must be used when travelling above 80km/hr. Not to exceed 110km/hr.  
**Load Rating:** 225kg lashing capacity.

1

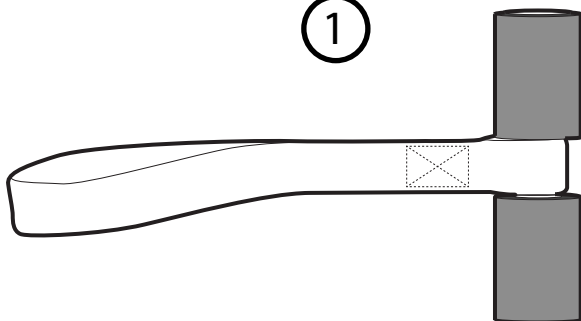

2

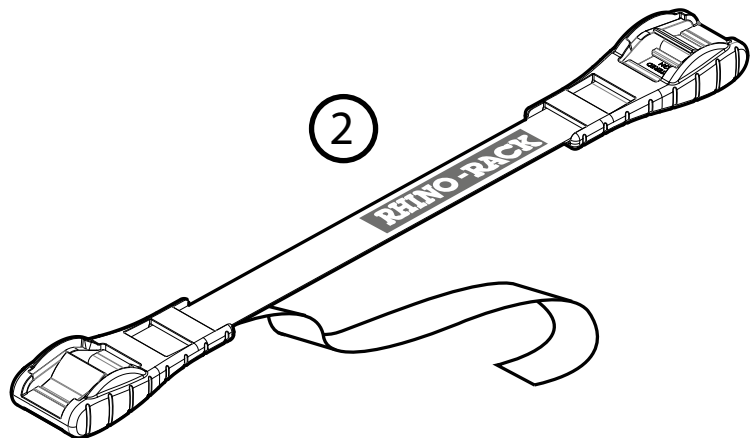

### Important Information

Rhino-Rack  
 3 Pike Street, Rydalmere,  
 NSW 2116, Australia.  
 (Ph) (02) 9638 4744 (Fax) (02) 9638 4822

Document No: R333  
 Prepared By: Kayle Everett  
 Authorised By: Chris Murty

Issue No: 02  
 Issue Date: 31/03/2015

These instructions remain the property of Rhino-Rack Australia Pty Ltd and may not be used or changed for any other purpose than intended.



# Rhino Rack Bow Strap Bonnet Tie Down (RBAS1)

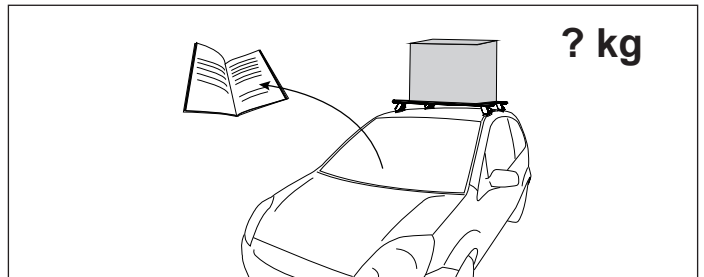
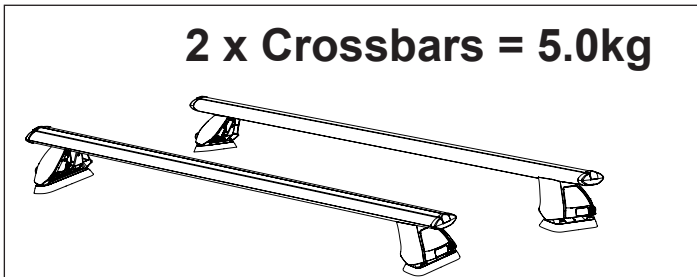
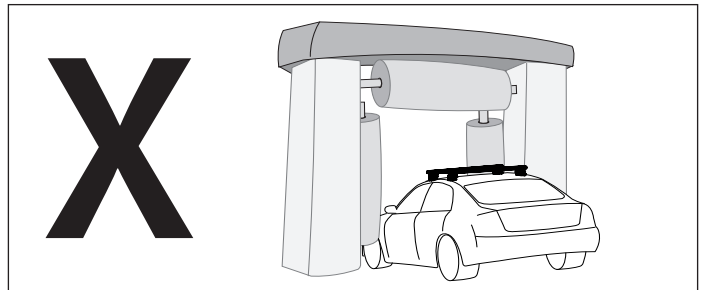
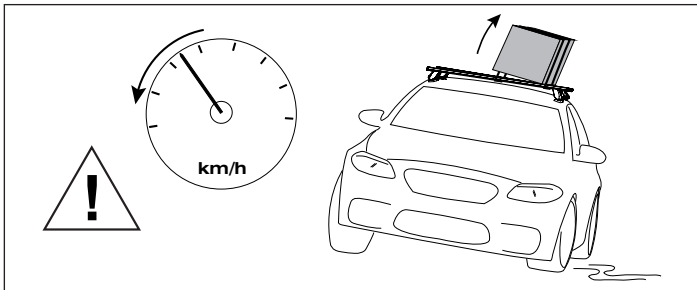
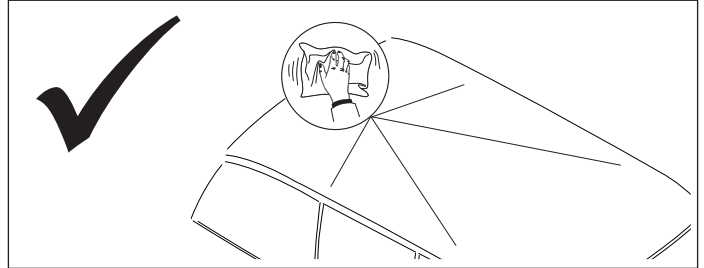
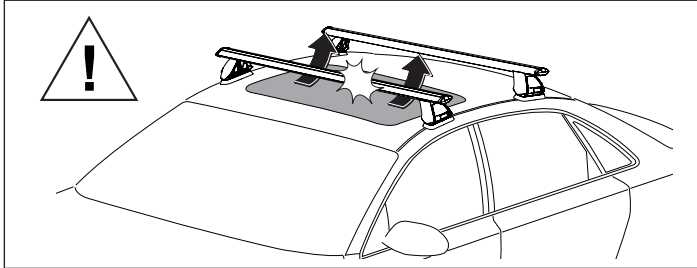
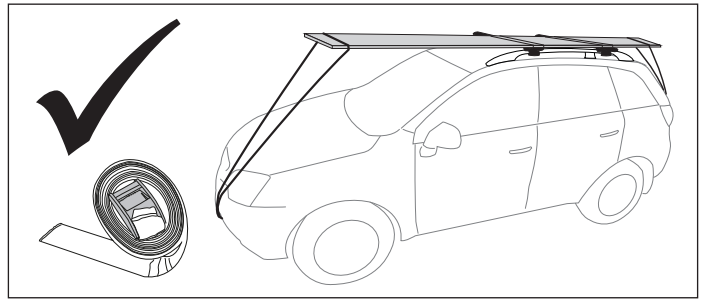
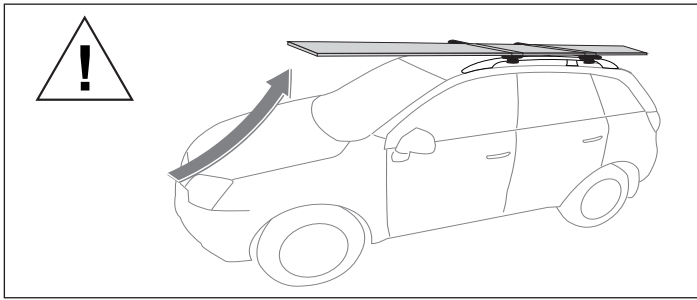

## WARNING! Important Load Carrying Instructions

With utility vehicles, the cabin and the canopy move independently. Roof racks and vehicle can be damaged if the item transported is rigidly fixed at points on both the cabin and canopy. Instead, rigidly fix to either the cabin roof racks or the canopy roof racks.

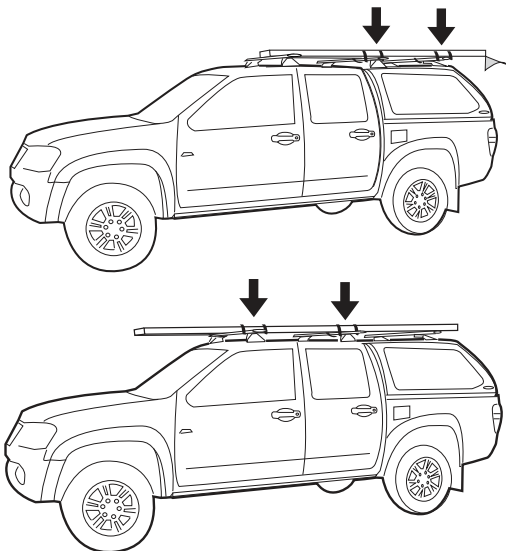

Paddle/ Surfboards should be fixed to the front of the vehicle.

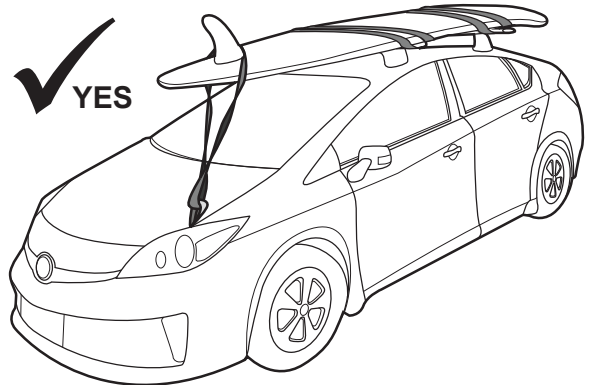



# Rhino Rack Bow Strap Bonnet Tie Down (RBAS1)

## Fitting instructions

- 1** Place the Anchor Strap onto the side of the engine bay. Suitable positions will vary depending on vehicle model and make.

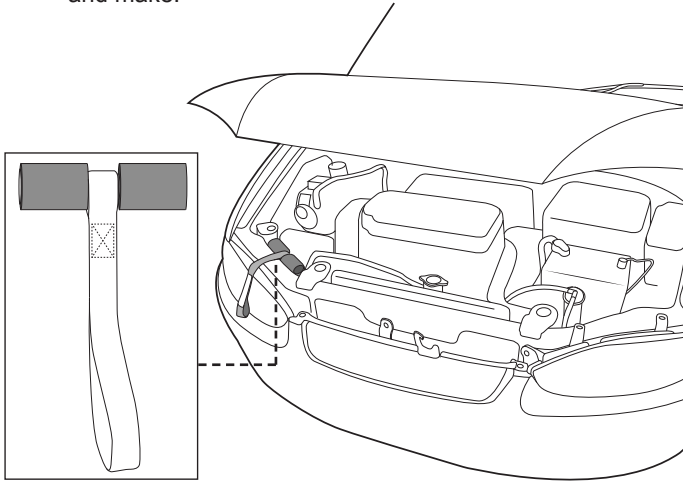

- 2** Close the hood of the vehicle, securing the Anchor Strap.

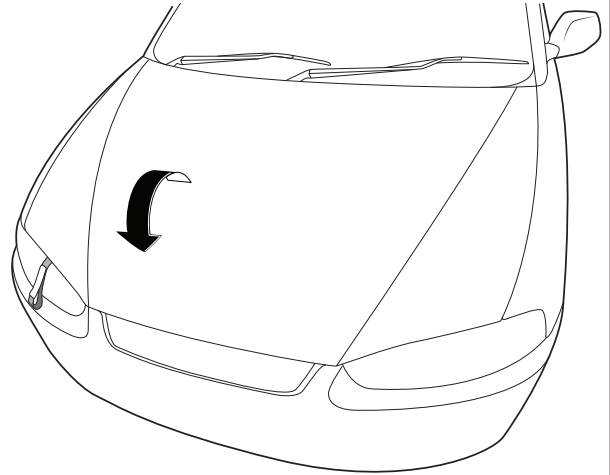

- 3** **Note:** Plan the positioning of strap to pull into the taper of the Kayak.

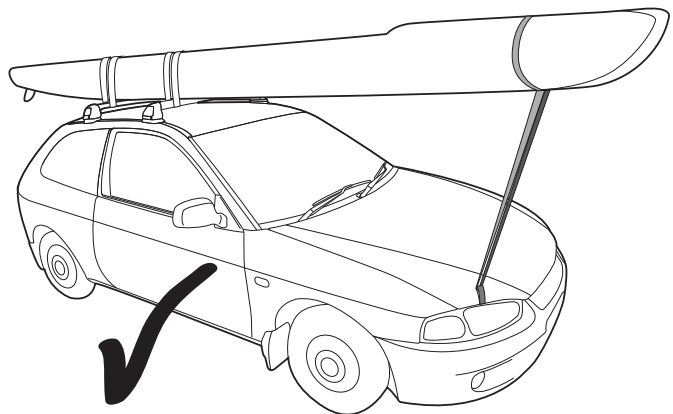
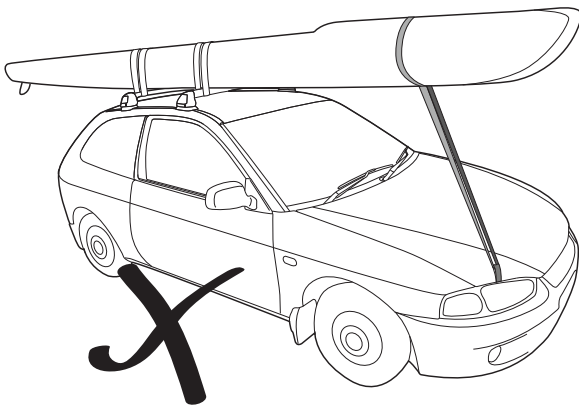

- 4** Place the Tie Down over the top of the kayak.

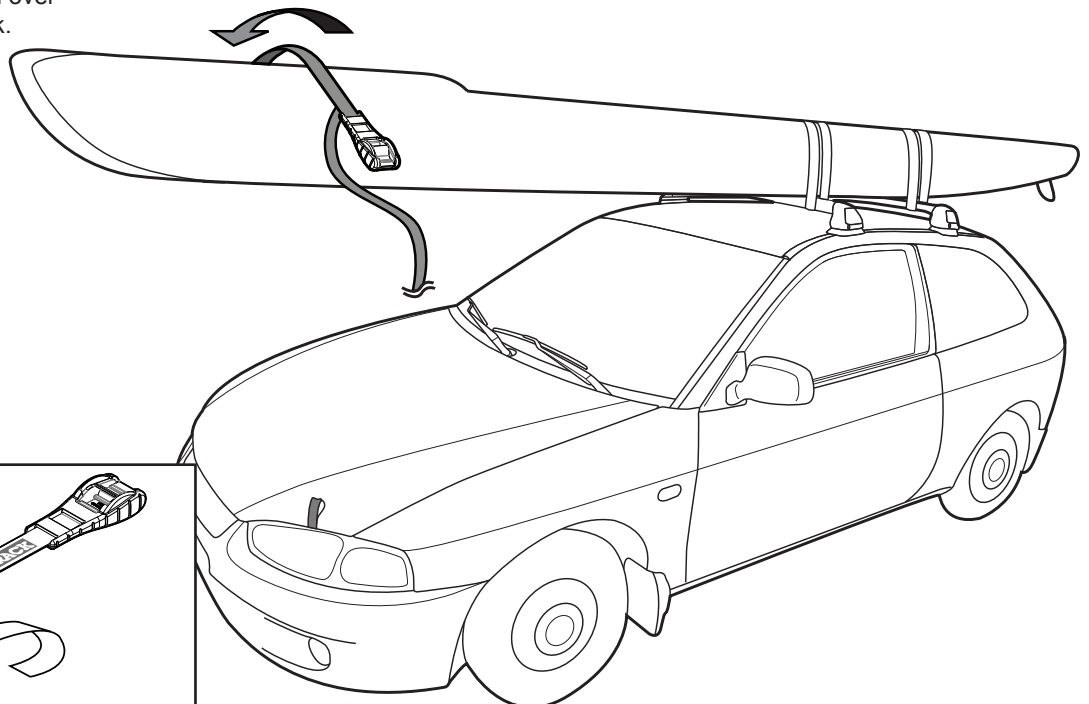



## Rhino Rack Bow Strap Bonnet Tie Down (RBAS1)

- 5** 1: Wrap the strap of the Tie Down around the bottom of the Kayak. 2: The strap then passes through the cam buckle. 3: Pass the strap down and through the loop of the anchor strap.

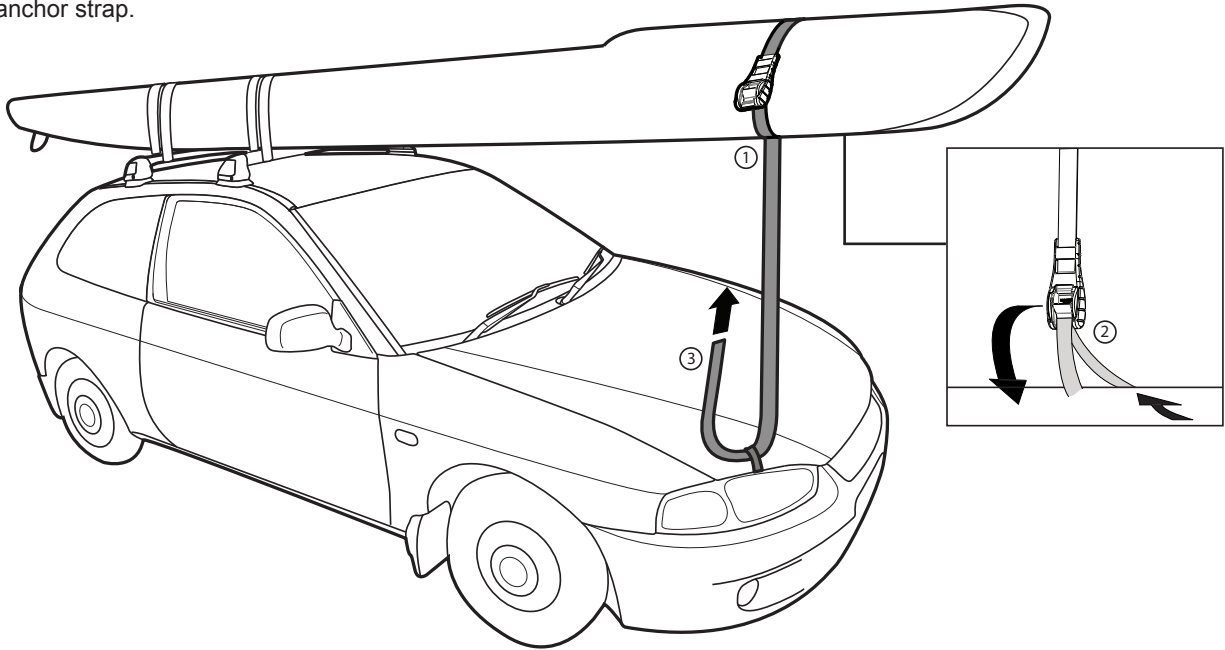

- 6** 1: Twist the strap around itself a few times as it is lifted toward the remaining cam buckle (this will stop wind vibration). 2: Pull the end through the cam buckle and pull taut.

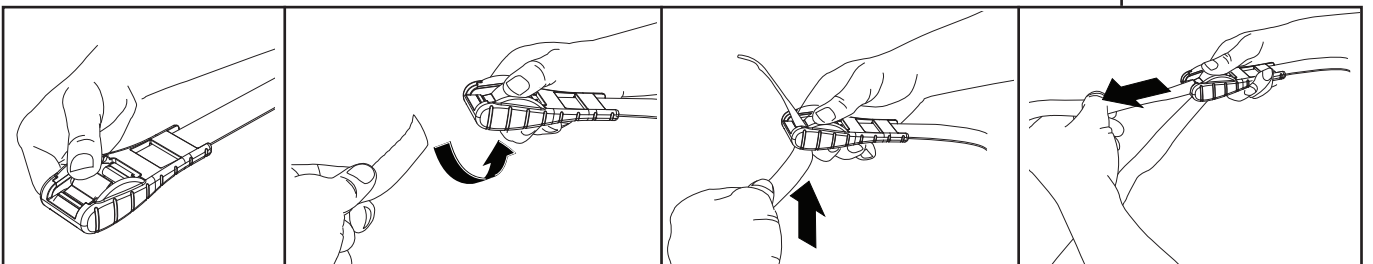
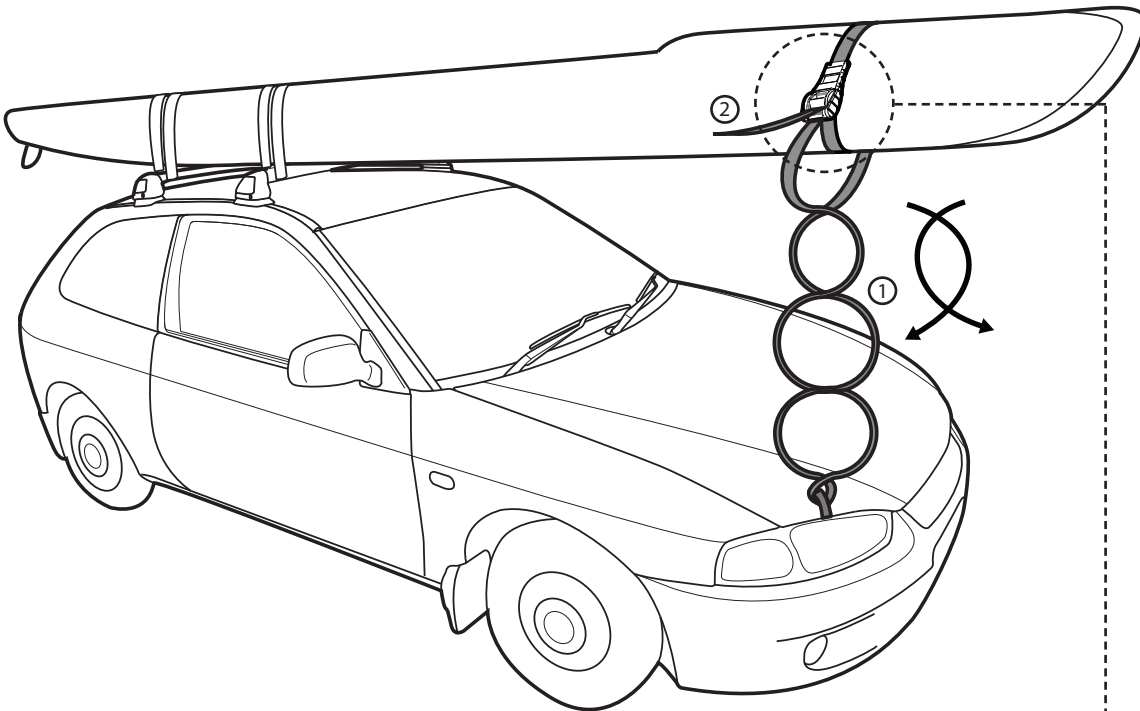



## Rhino Rack Bow Strap Bonnet Tie Down (RBAS1)

**7** Be sure Tie Down is secure before use.

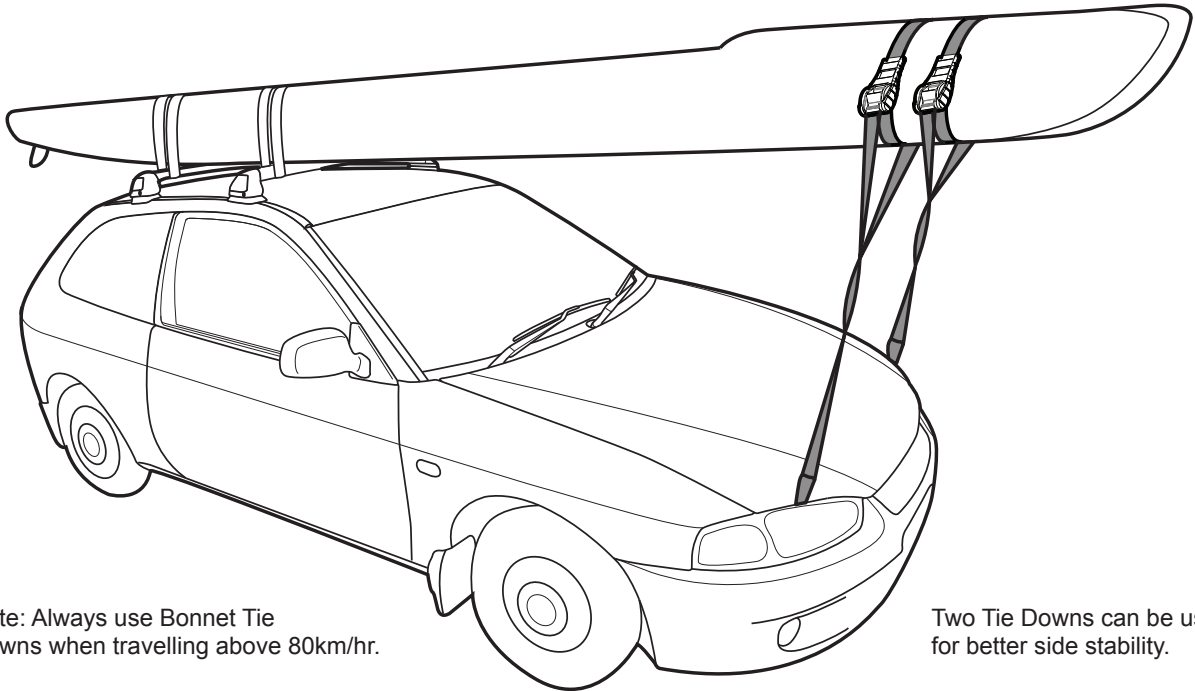

Note: Always use Bonnet Tie Downs when travelling above 80km/hr.

Two Tie Downs can be used for better side stability.

### DISCLAIMER

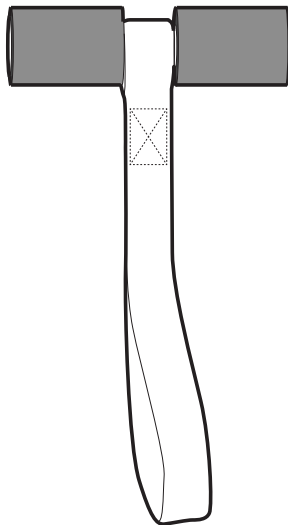

This product is designed to aid in the safety of transporting long items (i.e. Kayaks) and not to be used for towing or pulling applications. Special consideration must be taken when selecting your fixing point. Rhino-Rack Pty Ltd does not take any responsibility for damage to the vehicle that may be caused by this product on paintwork, panels and fixing hardware. Although they are designed with the softest materials in mind to minimise this damage, they cannot take into consideration the variation of panel gaps and wind flapping issues. It is the users responsibility to ensure that the strap is used in accordance with these fitting instructions.

#### Warning:

It is important that all roof racks and accessories are installed and attached correctly. Failure to follow the correct attachments could result in an accident, serious injury or death to others. The driver of the vehicle is responsible for securing the roof racks and accessories, checking the attachments, periodically checking bolt torque and visual inspection of all components for wear and damage. Do not attempt to fit the roof rack system or accessory to your vehicle unless you fully understand these fitting instructions. Please direct any questions regarding fitting to the dealer or retailer from where they were purchased.

**Use only non-stretch fastening ropes or straps.**

#### Note for Dealers and Fitters

It is your responsibility to ensure this fitting instruction is given to the end user or client