



INSTALLATION GUIDE

BBT058/ BBC058/ BBCD058

ISUZU D-MAX 3/2017+ 2WD & 4WD Models
(Not suitable for 2WD SX Single Cab)

ISUZU MU-X 2014 to 3/2017 2WD & 4WD Models



- Ironman 4x4 BBT/ BBC/ BBCD058 Bull Bars fit to a Isuzu D-Max 6/2012+ (Not suitable for 2WD SX Single Cab) Isuzu MU-X 2014 to 3/2017
- It will take about 4 hours to install.

NOTE: This product has been tested for air bag compatibility and therefore the mounting system MUST NOT be modified

IMPORTANT: Bull Bar installations should only be done by a qualified person and it is the responsibility of this person to ensure correct fitment.

1. Before installation check bull bar application is compatible with your vehicle.

2. Remove grill, front bumper, bumper bar reinforcement, bumper bar support brackets and front protection plate from under chassis.



3. Mark and trim plastic air deflector as shown.



4. Trim guard liner level with bottom of radiator support panel.



5. Install winch cradle and chassis strengthening brackets as shown using hardware provided.



Step continues over page...

Step 5 continued...



6. Using holes in inner and outer of chassis strengthening brackets as a guide, drill a 12.5mm hole and install a mounting bolt washer, spring washer and nut. Tighten all bolts.



7. Remove foglight surrounds from bumper bar and mask a line across the bumper level with the top of the lower grill opening and top of the fog recesses.

Foglight recess might vary from images shown here, depending on age of vehicle but the cutting process remains the same.



8. Using an air hack saw or similar, cut along line previously marked to remove the lower section of the bumper bar.



9. Place cutting template on the ends of the bumper and mark as shown.



10. Cut along lines previously marked to remove sections as shown.



If winch is not being installed, refer to Step 18

11. Before winch can be installed, bumper reinforcement will need to be cut to allow for clearance.

To do this, place winch on mounting cradle and with a felt tip pen, trace a line above the top edge onto bumper reinforcement.



12. Remove winch and cut along line previously marked.

Install pinch weld.



13. Attach winch to mounting cradle as shown.

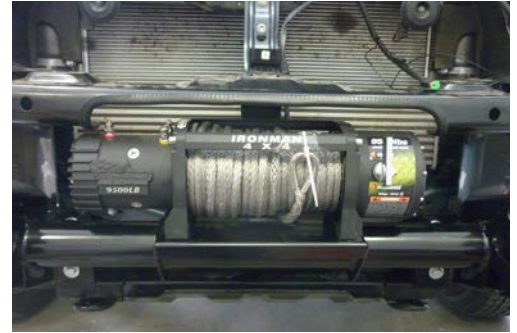

14. Refit top section of bumper bar to vehicle using original clips.

15. Cut clearance into front bumper for clutch handle as shown.



16. Cut return from bumper bar to allow clearance for the winch as shown.



17. Install a pinch weld to cut ends of bumper bar.



18. Unwrap bull bar. Check over riders and light assemblies are tight in bull bar before installation.

19. Fit bull bar to chassis brackets using M12 bolts, flat washers, spring washers and nuts provided.

20. Align bull bar with vehicle and tighten all bolts.



21. Once bar is aligned with vehicle and tightened drill through pinning holes between bull bar and chassis bracket and secure with bolts, washers and nuts provided.

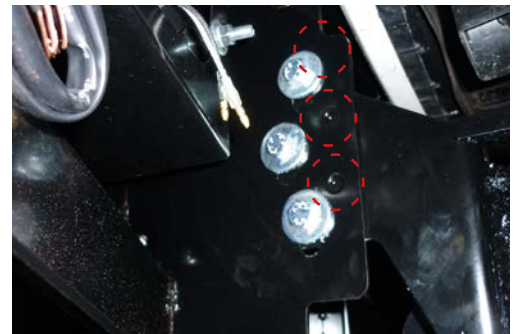

22. Bolt fairlead to recess in front of bull bar using bolts, washers and nuts provided.



23. Mount control box in desired location.



24. Connect three colour coded cables to the corresponding poles on winch motor.



25. Connect the thin black earth wire and negative battery cable to the earth connection on the opposite side of winch motor.



26. Run the positive and negative battery cables into the engine bay taking care to secure cables away from any sharp or moving objects.

27. Connect positive and negative battery cables main battery of vehicle (Not Auxilliary Battery).

28. Attach breather hose to barb fitting on winch motor. Run hose to the highest available point in engine bay and cable tie in position. Cable tie hose away from any sharp, hot or moving objects.



29. Trim corners of mud guard liners and tuck behind lip of bull bar.



32. Connect park lights, indicators and fog lights as per wiring diagrams at the back of fitting instruction manual.

33. Fit protection plates to underneath of bull bar using M8 bolts, spring washers and flat washers provided.



Wiring Diagrams

PARK LIGHT & INDICATOR

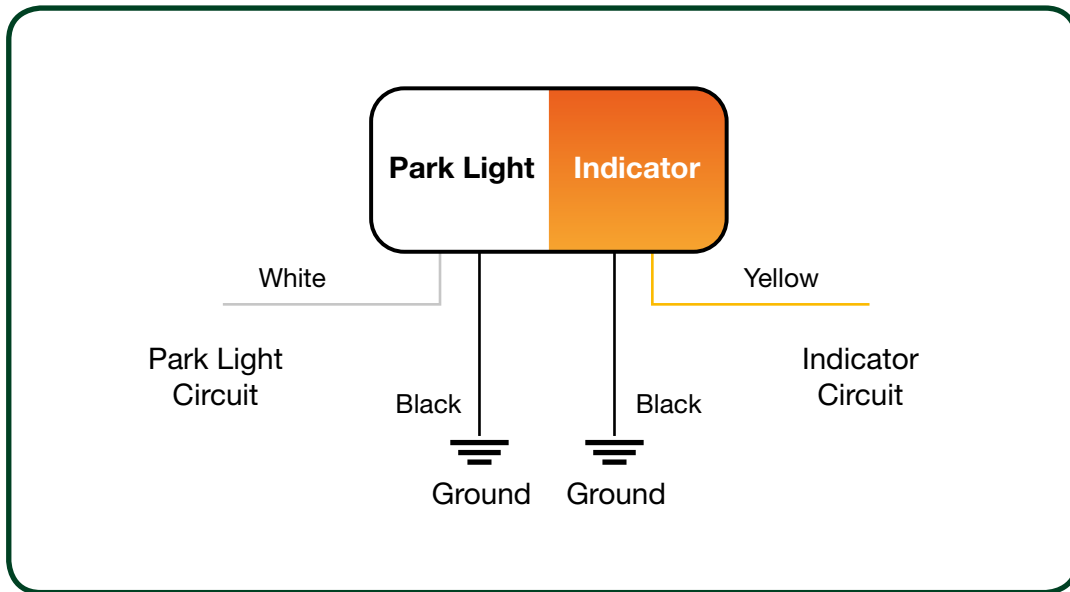

FOG LIGHTS

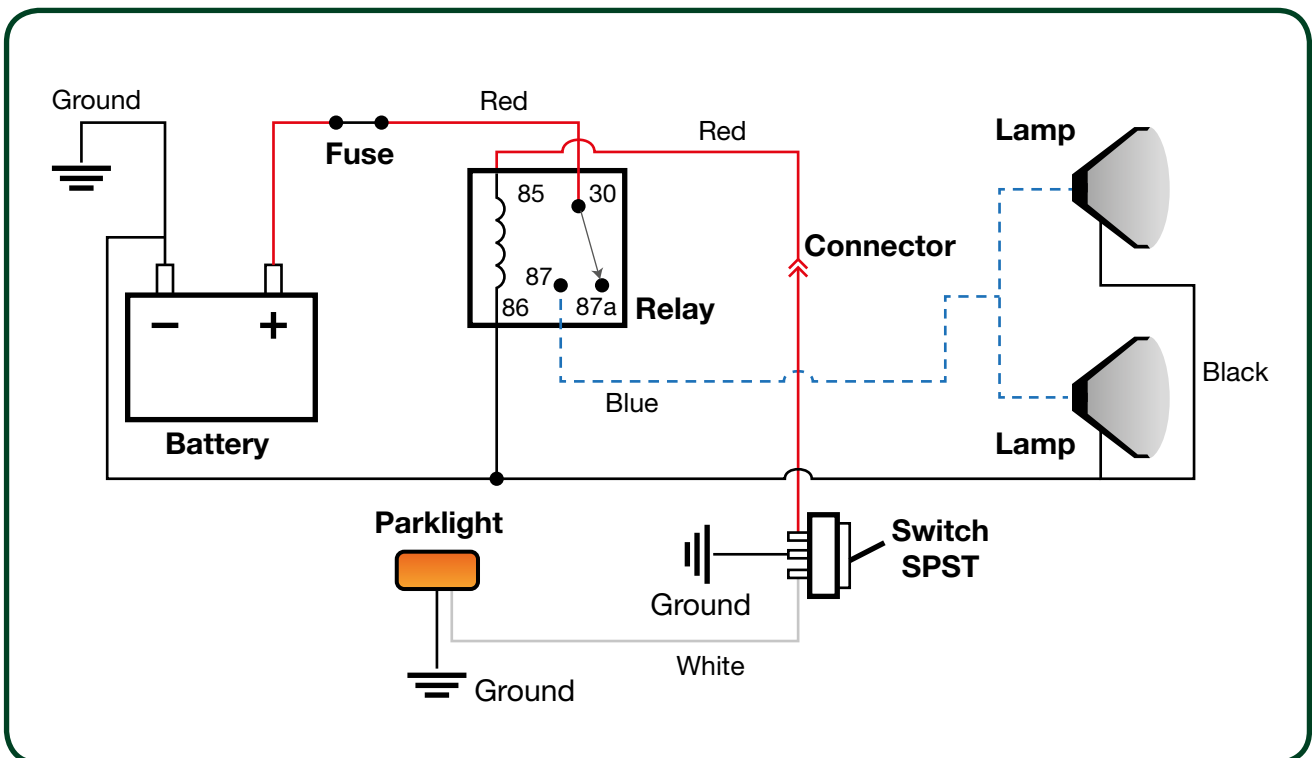



**2WD & 4WD ISUZU D-MAX 6/2012+
(Not suitable for 2WD SX Single Cab)**

**2WD & 4WD ISUZU MU-X
2014 to 3/2017
BULL BAR TEMPLATE**

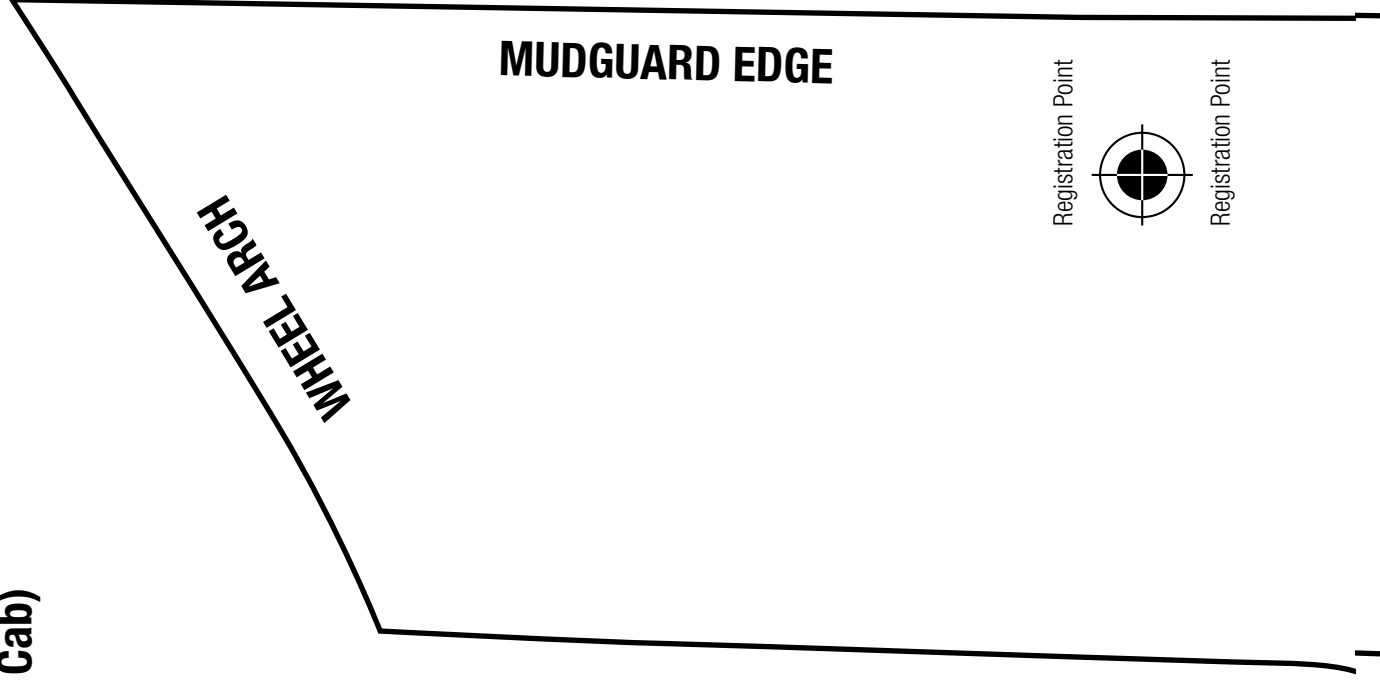

Registration Point



Registration Point

Registration Point



Registration Point

Registration Point



Registration Point

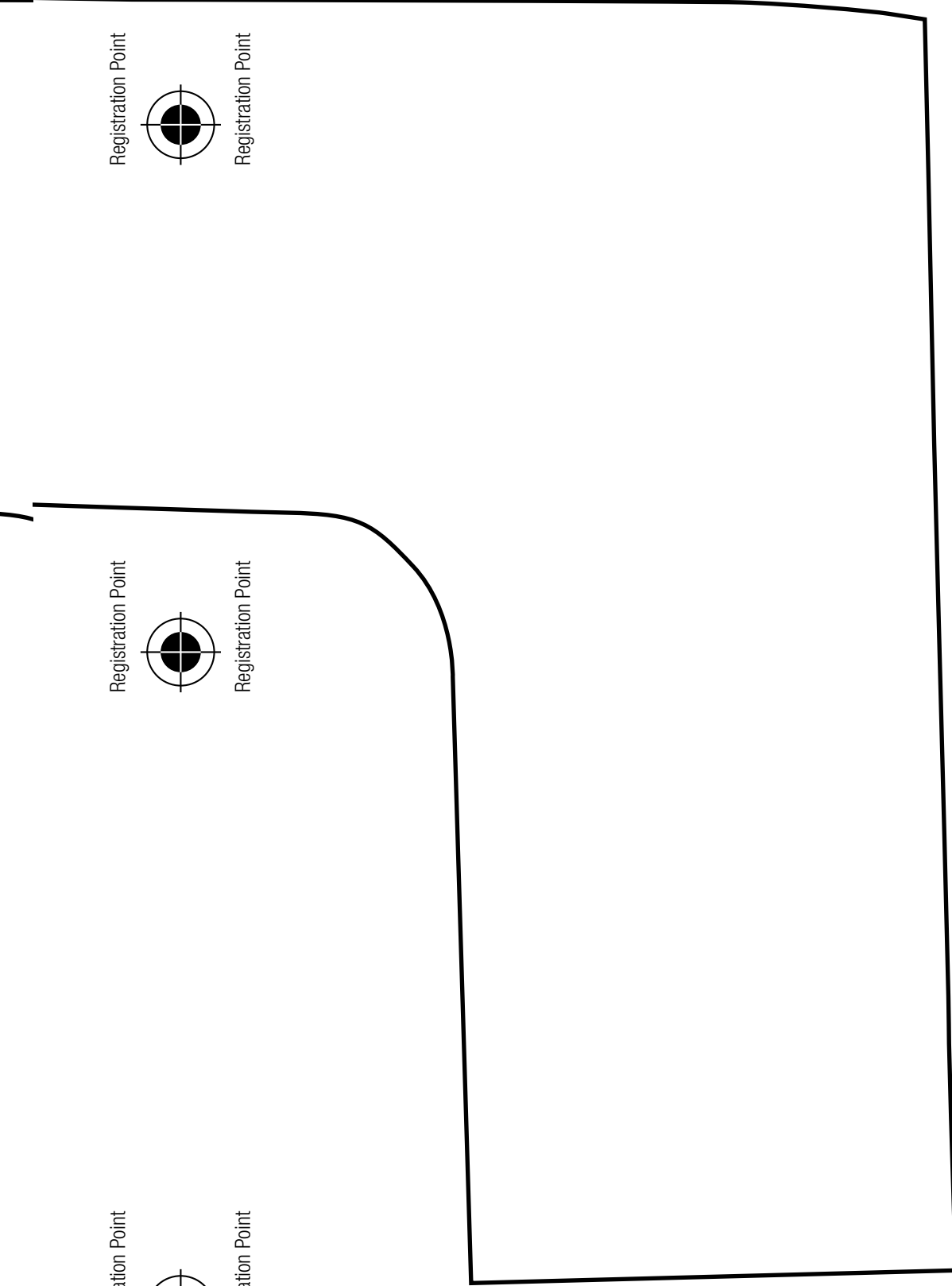
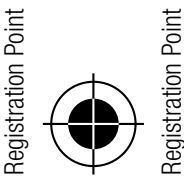

**2WD & 4WD ISUZU D-MAX 6/2012+
(Not suitable for 2WD SX Single Cab)**

**2WD & 4WD ISUZU MU-X
2014 to 3/2017
BULL BAR TEMPLATE**