



Hommix ziRO

ZERO INSTALLATION COUNTERTOP
REVERSE OSMOSIS WATER PURIFIER

USERS MANUAL V1.0

Prior to using the product, we kindly urge you to thoroughly go through this instruction manual. While it's largely a plug-and-play setup, referring to this manual can be beneficial.



Contents

Once you're done reading, please hang on to this manual for future use.

1. Packing List	4
2. Product Structure and Size	4
1. Structure diagram	4
3. User Interface	5
Important Notices	5
4. Safety Precautions	6
1. Important	6
2. Advisory	6
5. Maintenance	7
1. Cleaning the Hard Water Tank and Pure Water Jug/Kettle	8
2. Descaling of the Hard Water Tank	8
6. Instructions for First Use	8
7. Functionality and Usage Guide	10
1. Child Lock Function	11
2. The Flushing Process	11
3. Water Production	11
4. Water Temperature Controls	12
5. Water Amount Adjustment	12
6. Dispensing Warm - Boiling Water	12



7. Pure Water Jug / Kettle Display	13
8. Changing the Water	13
9. TDS Level Display	13
10. Winter Mode	13
11. Plateau Mode (Boiling Point Adjustment)	14
12. High Temperature Sterilisation	14
13. Efficient One-Key Emptying Function	14
14. Standby State	15
15. Sleep State	15
16. Purified Water Quality Light	15
17. Filter Replacement and Reset Procedure	15
18. Heated Water Dispensing Indicator	16
19. Specifications	17
20. Waterway map	17
21. Circuit Diagram	18

8. Product Purification Process	18
9. Important Information	19
10. Declaration of Conformity	20
11. Error Codes and Troubleshooting	21
12. Warranty & After Sales	23

1. PACKING LIST

NAME	QUANTITY
Hommix ziRO	×1
Activated Carbon + RO Membrane Filter Cartridge	×1
Activated Carbon + Mineral Filter Cartridge	×1
Drip Tray	×1
Pure Water Jug	×2
Hard Water Tank	×1
Instruction Manual	×1

We recommend retaining the original packaging for your system, as it may be needed in the event of future repairs.

2. PRODUCT STRUCTURE AND SIZE

01. Structure Diagram

Applicable water quality: Municipal tap water.

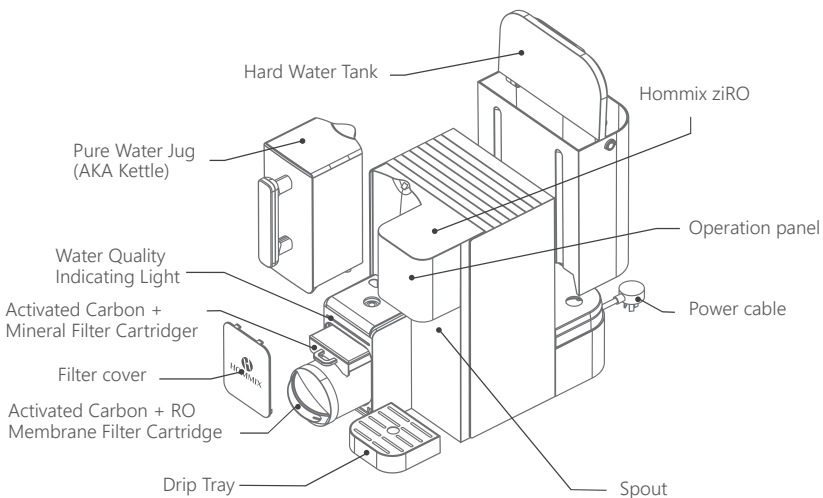

3. USER INTERFACE

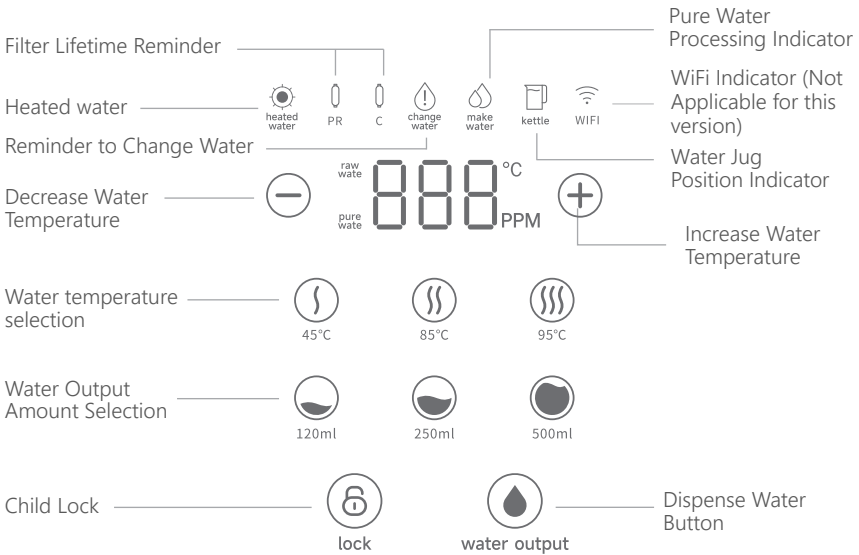

IMPORTANT NOTICES!

- **Keep out of reach of children!**

Important Notice: This machine dispenses boiling water, which can be dangerous when in the reach of children. The owner must responsibly use and educate others on safely operating the boiling water function of the system.

- **Water Tank Maintenance**

Please ensure that everyone using the system is aware of the need to empty the water inside the hard water tank whenever they wish to refill. Neglecting this crucial step may lead to systems malfunctions, blockages in the filters, affecting the system's performance.

- **Filter Change Importance**

Ensuring filters are replaced within the specified timeframes is crucial for maintaining both optimal filter and device performance.

4. SAFETY PRECAUTIONS

Important!

- **Stable Placement:** Ensure the Hommix ziRO is firmly positioned on a table or worktop and not suspended in the air on a shelf for example.
- **No Mixed Liquids:** Do not introduce muddy tap water, ice cubes, milk, fruit juice, or any mixed liquids into the hard water tank.
- **Electrical Safety:** Do not use a universal socket concurrently with other electrical devices; use a socket rated at least 10A.
- **Alcohol-Free Cleaning:** Refrain from cleaning the water tank with alcohol.
- **Heat Source Distance:** Install the product at a safe distance from heat sources.
- **Cord Damage Alert:** If the power cord becomes damaged, please arrange for its replacement through the original place of purchase, the product's official website, authorised resellers, or distributors.
- **Grounding Necessity:** Verify that the socket linked to this product's power cord is equipped with a reliable grounding mechanism.
- **Cold Temperature Advisory:** When the ambient temperature falls below 0°C, please ensure that you empty the hard water tank and the pure water jug when it's not in use to prevent freezing.
- **Cleaning Caution:** When cleaning the hard water tank, take care not to dislodge the water inlet filter or silica gel. If they become detached, promptly reinstall and restore them.
- **Safe System Placement:** Do not place the system in areas susceptible to combustible gas leakage or near any flammable substances.
- **No Water Immersion:** Avoid submerging the system in water for cleaning.

Advisory

- **Safe Placement:** Ensure placement on a flat, clean, heat-resistant surface to prevent potential hazards.
- **Moving while Active:** Do not move the system while it is going through the purification process. Please wait until the pure water jug is full before moving.
- **Handle with Care:** Exercise caution when handling to prevent product scratches or damage.
- **Weather Caution:** Avoid exposure to rain and snow during transportation and storage. Please refrain from placing the system at a location with direct sunlight.
- **Water Quality:** If raw water doesn't meet tap water standards (e.g., contains high sediment or excessive chlorine), it can significantly reduce filter element life. In this case, pre-treat raw water before adding it to the hard water tank.

- **Stability Reminder:** When removing the hard water tank, ensure system stability to prevent tipping.
- **Safe Usage:** To prevent accidents, individuals with physical, mental, or organ impairments and children should not use the product without supervision from capable adults.
- **Regular Filter Replacement:** Maintain optimal performance by replacing the filter element regularly, and always flush it after replacing it (Section 6.5 - Page 10).
- **Extended Production Time:** In colder conditions, the water tank's production time may increase due to the membrane element's nature.
- **Heating Safety:** The system's design includes instant heating, and the outer shell may become slightly hot during use, which is normal.
- **Temperature Caution:** Be cautious when switching from higher temperature water to lower temperature water, as the fresh water may still be really hot and cause skin harm.
- **Usage Altitude:** This product is suitable for altitudes below 1,500 metres above sea level, for example mountain hiking. Stop use if the inlet water temperature falls below 5°C or rises above 38°C.
- **Factory Testing:** Some water may escape when opening the PE bag because the machine undergoes water testing at the factory; this is a normal occurrence.

5. MAINTENANCE

Machine Care During Extended Periods of Non-Use

If the product remains unused for a couple of days, we advise filling up the hard water tank (empty before filling up if there is water inside already) and then emptying two jugs of pure water. This is important for optimum quality of water.

If you anticipate an extended period of non-use, roughly around a week or more, we recommend the following steps to ensure the machine's optimal condition:

- Begin by emptying both the system's hard water tank and the pure water jug.
- Disconnect the power supply to the system.
- Remove the filters from the system (Section 7.17.2 - Page 16).
- Insert the filters in sealable bags and seal it up
- Store the filters in a cool, fresh-keeping section within your refrigerator, maintaining a temperature range of 2-5°C. Be sure not to place it in the freezer section.
- Meanwhile, keep the system in a cool dark place, for example a kitchen cabinet

When you are ready to use the system again, please follow the initial setup and cleaning instructions as you did during its first use.

1. Cleaning the Hard Water Tank and Pure Water Jug / Kettle

When visible debris accumulates at the bottom of the hard water tank or pure kettle, it should be washed with water. If rinsing alone does not suffice, please use a cleaning brush to thoroughly remove the debris.

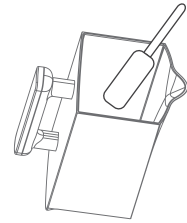

2. Descaling of the Hard Water Tank

To maintain the hard water tank's optimal performance, regular descaling is essential, with a recommended interval of once every 3 months. This helps prevent severe scaling buildup that may become difficult to clean.

To perform the descaling operation, follow these steps:

- Fill the hard water tank halfway with water.
- Add 30 grams of citric acid to the water and stir until it dissolves.
- Allow the solution to soak for a minimum of 2 hours (keep it separate, do not place it on the water tank seat).
- After the soaking period, empty the citric acid solution from the tank.
- Thoroughly clean the water tank with a sponge and water.
- Your hard water tank will now be ready for normal use.

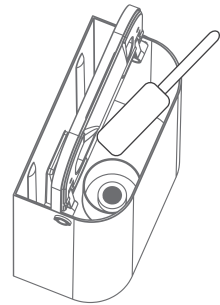

6. INSTRUCTIONS FOR FIRST USE

Notice:

To ensure the safety of both yourself and others, and to prevent any potential harm or damage to property, please adhere to the following safety precautions. Ignoring safety guidelines and misuse may lead to accidents:

1. Begin by opening the package and placing it on a level, horizontal surface of your choice. Then, proceed to install the drip tray.
2. Install the pure water jug / kettle into the position (please see image below), ensuring it is securely fastened (the jug must be properly locked in place).

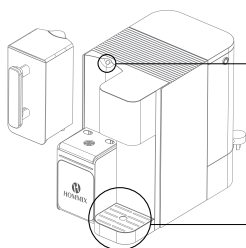

Install the Pure Water Jug / Kettle
Note: The jug must be securely placed to the machine body as illustrated

Install the drip tray (magnetic)

3. Remove the filter cover, install the Activated Carbon + RO Membrane Filter Cartridge and the Activated Carbon + Mineral Filter Cartridge as illustrated below, and then reattach the filter element cover."

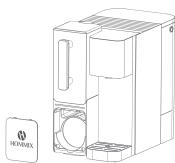

Step 1: Remove the filter cover



Step 2: Install the Activated Carbon + RO Membrane Filter Cartridge

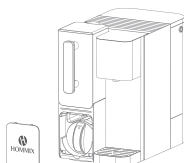

Step 3: Rotate the filter clockwise to the marked position

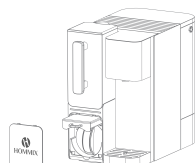

Step 4: Install the Activated Carbon + Mineral Filter Cartridge until firmly in place

4. To fill the hard water tank, lift it carefully while pressing the top of the system to prevent it from shifting. Once lifted, fill it with tap water, then return the water tank to its original position behind the system. Ensure the water tank cover aligns flush with the machine's top, and proceed by turning on the power. You'll hear a "beep" sound, and the display panel will light up, indicating that the machine is now operational.

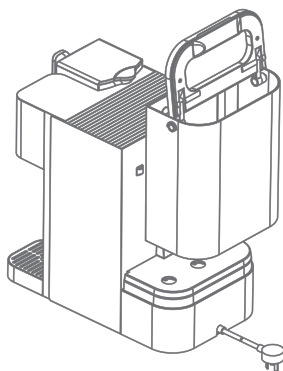

Step 1:

Lift the hard water tank upwards by holding onto the inbuilt handle on the lid and fill it up with tap water

Step 2:

Turn on the power and the system is now operational and it will automatically initiate the water purification process

5. For optimal filtration performance during the initial use, follow these steps:
 - a. Empty the water from the pure water jug after completing the water purification process for the first time and continuously repeat this process until you have filled the hard water tank approximately 5 times. This will take approximately 30 minutes.
 - b. During the first water purification cycle, you may notice that the water in the pure water jug appears white and cloudy. This occurrence results from the air within the high-precision filter element and is a normal occurrence due to the generation of minuscule air bubbles.
 - c. To prevent dry heating, the system will initially dispense water at room temperature each time it is powered on before transitioning to hot water. Therefore, for making tea we would advise dispensing approximately 50ml, emptying your cup and then continue dispensing the desired amount.
 - d. Your Hommix ziRO comes with a factory default boiling point and boiling water temperature of 100°C. To prevent water from spraying out, it is essential to conduct a boiling point adjustment during the initial use to calibrate it according to your local conditions.

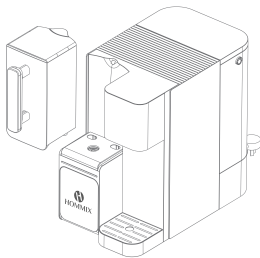

Note

For optimum purification performance, follow these steps (explained above):

1. Fill the hard water tank to its max capacity.
2. Ensure the pure water jug is correctly positioned.
3. Once the jug is full, empty it and allow it to refill.
4. When the "change water" icon starts flashing, empty any remaining water in the hard water tank.
5. Repeat this process until you have filled the hard water tank a total of 5 times.

7. FUNCTIONALITY AND USAGE GUIDE

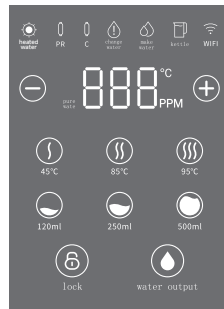
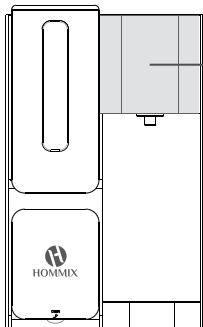

1. Child Lock Function

- When your Hommix ziRO is activated and a temperature above 45°C is chosen, the "🔒" indicator will illuminate, and you must first unlock the water function.
- To deactivate the child lock feature, simply press the "🔒" button, and you'll hear a brief beep confirming that the child lock has been turned off.
- Once the child lock is deactivated, you can press the "💧" button to dispense water
- To completely disable the child lock function, press and hold both the "🔒" and "🚫" buttons simultaneously for 3 seconds. You'll hear a short beep to confirm the cancellation.

2. The Flushing Process

- The system undergoes a flushing cycle both before and after water production.
- Throughout the flushing process, the "Pure Water Processing Indicator" 💧 indicator rapidly flashes.
- To initiate forced flushing, press and hold the "🔒" and "🚫" buttons simultaneously for 3 seconds. The system will commence a 3-minute flushing cycle, signified by a brief beep.
- To exit the flushing mode, press and hold the "🔒" and "🚫" buttons for 3 seconds once more. You'll hear a short beep confirming the exit.

3. Water Production

- When the water level in the pure water jug is low, the system automatically initiates the water production process, and the 💧 "Pure Water Processing Indicator" illuminates.
- Once the water production reaches the complete water level, the 💧 "Pure Water Processing Indicator" turns off.
- In the event of low water levels in the pure water jug, the 💧 "Pure Water Processing Indicator" flashes.

4. Water Temperature Controls

- For room temperature water, simply ignore the options on the control panel and lift the pure water jug and use it to fill up your glass / bottle.
- The system offers three distinct water temperature settings: "Low (🔥) - 45°C," "Medium (🔥🔥) - 85°C," and "High (🔥🔥🔥) - 95°C".
- The system offers simple temperature control with easy adjustments. Choose the water temperature button, and the display will indicate the current water temperature. Click the temperature symbols "⊕" and "⊖" to incrementally raise or lower the temperature, with each press adjusting by 1°C. For quicker temperature adjustment, press and hold the temperature increase or decrease buttons. The temperature range spans from 45°C to 100°C.

5. Water Amount Adjustment

- If you don't choose a specific water volume, the system will dispense 1 litre by default.
- You can pick from three different water levels: "120ml - (🍵)", "250ml - (🍵)" and "500ml - (🍵)".

6. Dispensing Warm - Boiling Water



The diagram shows a control panel with a digital display at the top showing '95 °C' and '000 PPM'. Below the display are three temperature buttons: 45°C (🔥), 85°C (🔥🔥), and 95°C (🔥🔥🔥). Below these are three volume buttons: 120ml (🍵), 250ml (🍵), and 500ml (🍵). At the bottom are two buttons: 'lock' (🔒) and 'water output' (💧). Lines connect these elements to text instructions.

The display indicates the current temperature setting

Step 1: Select desired temperature

Step 2: Select the desired amount

Step 3: Press the child lock button to deactivate the child lock

Step 4: Press the "water output" button, the "water output" indicator will remain illuminated while dispensing. Press "water output" again to stop.

7. Pure Water Jug / Kettle Display

When the jug is in place, "  " is always on; if the jug is not in place, "  " and the Pure Water Processing Indicator  lights will flash.

8. Changing the Water

When you see the "  " light flashing, it's time to change the water in the hard water tank. You should consider changing the water in the following situations:

- The water level in the hard water tank reaches or drops below the minimum level.
- It has been over 48 hours since the last water change.
- You have lifted or moved the hard water tank.





!! Please note: Do not add water directly to the hard water tank without first emptying the left over concentrated water, this must be poured before refilling. To avoid pouring this down the drain, you can use the remaining water for watering plants. !!

9. TDS Level Display

Shows the TDS (Total Dissolved Solids) value on the display while the system is in standby mode. Please note the TDS reading may not be accurate due to the added minerals with the ACM filter.

10. Winter Mode

When the tap water temperature drops below 10°C, we advise activating the system's winter mode:

- Press and hold both the "  " and "  " buttons simultaneously for 3 seconds. You'll hear a short beep, indicating that the system has entered winter mode. In this mode, the outlet water temperature stabilises at a comfortable 25°C within the normal range.
- To exit winter mode, long-press both the "  " and "  " buttons for another 3 seconds, and you'll hear a short beep confirming the deactivation.

11. Plateau Mode (Boiling Point Adjustment)

- To initiate plateau adjustment mode, press and hold both the "Ⓢ" and "⊖" buttons for 3 seconds, and you'll hear a short beep.
- While in this mode, the display will indicate a flashing temperature. Use the "⊕" and "⊖" buttons to set the desired boiling point temperature.
- To confirm your temperature selection, press and hold both the "Ⓢ" and "⊖" buttons for 3 seconds once more, and you'll hear a short beep, indicating that the temperature setting is complete.

12. High Temperature Sterilisation

- Press and hold both the "Ⓢ" and "Ⓢ" buttons for 3 seconds, signified by a short beep, to activate the high-temperature sterilisation mode, lasting for 60 seconds.
- During this process, the screen will display a countdown from 60 to 00 seconds, and once sterilisation is finished, the water will return to its previous dispensing state.

13. Efficient One-Key Emptying Function

This function allows you to completely empty the pure water jug (1.4L) at the desired temperature.

- Press and hold the "Ⓢ" and "●" buttons for 3 seconds, signalled by a short beep, to activate the one-key emptying mode.
- While in this mode, the display screen will flash. Press the "Ⓢ" button to initiate water discharge, and press the "Ⓢ" button to stop the water discharge process as required.

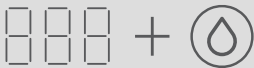

(888 and "water output" light will flash when this mode is activated)

Please note: After using this feature, you may come across the E4 error. Simply turn the device off, wait 5 seconds and then turn on again. The initial water dispensed will be room temperature for the first few seconds, and then the hot water will follow.

14. Standby State

- If there's no activity for 30 seconds after dispensing water, the machine will automatically return to standby mode.
- While in standby mode, the display will showcase the TDS value, and all other indicator lights will be turned off.
- To re-activate the interface from standby mode, simply touch any button on the machine.



15. Sleep State

- If the machine is not operated for 5 minutes, the machine will enter into sleep state (all indicator lights are off);
- When the machine is in sleep state, touch any button to wake up the interface.

16. Purified Water Quality Light

- The kettle's indicator will illuminate in blue if the pure water has been replaced within 12 hours.
- If the pure water has not been replaced for over 12 hours, the indicator will turn red.

17. Filter Replacement and Reset Procedure

17.1. Filter Lifetime Display (PR / C on the Display)

- Steady White: Filter lifetime is higher than 10%
- Flashing Red: Filter lifetime is less than 10% (If you do not have replacement filters already, we recommend purchasing them at this point)
- Steady Red: Filter lifetime has expired

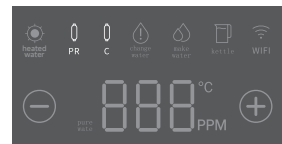

Stages	Filter Configuration	Recommended replacement cycle
Stages 1 - 3	PP, Activated Carbon + RO Membrane Filter (PR)	6 - 12 Months
Stages 4 - 5	Activated Carbon + Alkaline Ceramic Balls (C)	3 Months

17.2. Filter Replacement Steps

- Turn off the power supply and open the filter element cover.
- To replace the AC+RO filter; rotate the filter anticlockwise by holding the handle to the unlocked "🔓" position and then pull towards yourself.
- Insert the new filter into the system and securely twist it clockwise until it reaches the inverted triangle "▼" position.

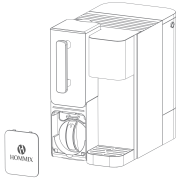

Step 1: Remove the Filter Cover (pull from the bottom).

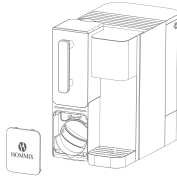

Step 2: Rotate the AC+RO filter anti-clockwise and then pull out.

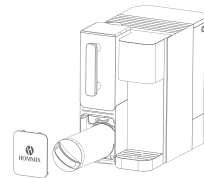

Step 3: Insert the new filter and turn it clockwise to lock into place.

- To replace the AC+Alkaline Filter, simply remove the old filter by pulling the filter out (may require some force).
- Install the new filter element in its original position, aligning the end faces.
- Reconnect the power supply and initiate the initial flushing process, as done during the initial setup (Section 6.5 - Page 10).

17.3. Filter Lifetime Reset

- To reset the AC+RO filter: Press and hold both the "Ⓞ" and "☺" buttons for 3 seconds, you'll hear a short beep lasting 0.5 seconds.
- To reset the AC+Alkaline filter: Long-press both the "Ⓞ" and "☺" buttons for 3 seconds, you'll hear a brief 0.5 second beep.
- After installing a new filter element and performing the reset, the filter element icon will revert to white.

18. Heated Water Dispensing Indicator

The cool white "Heated Water" display light illuminates when warm or boiling water is dispensed from the water spout.



19. Specifications

Reverse Osmosis Countertop Drinking Machine

Product name	Hommix ziRO - Zero Installation Countertop Reverse Osmosis Water Purifier		
Product Model	HMZXRO-150	Functionality	Water purification with instant heating
work pressure	0-0.4MPa	Rated total net water volume	4000L
Applicable water temperature	5°C-38°C	Rated input voltage	220V~50Hz
Hot water capacity	20L/h($\geq 90^{\circ}\text{C}$)	Rated total power	2200W
protection type	Type I	Clean water flow	0.4L/min
Applicable water source	Municipal tap water	date of manufacture	See body barcode for details
Hard Water Tank Capacity	4.5L	Pure Water Jug Capacity	1.4L
Product Size	230*420*375mm (width*depth*height)		

- The rated clean water flow rate is determined under the condition of municipal water at 25°C.
- The actual total net water volume may vary depending on the water quality and local usage conditions.

20. Waterway Map

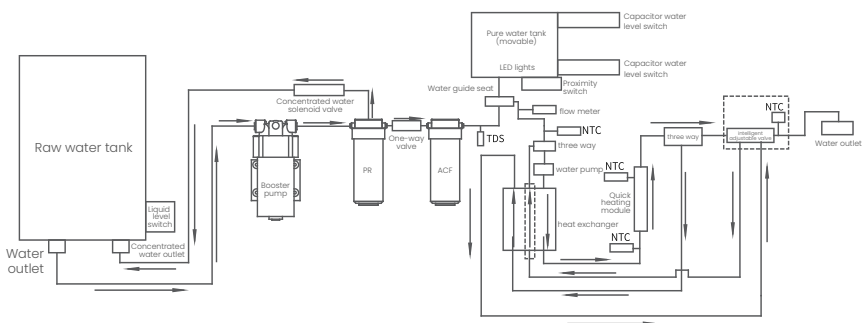

21. Circuit Diagram

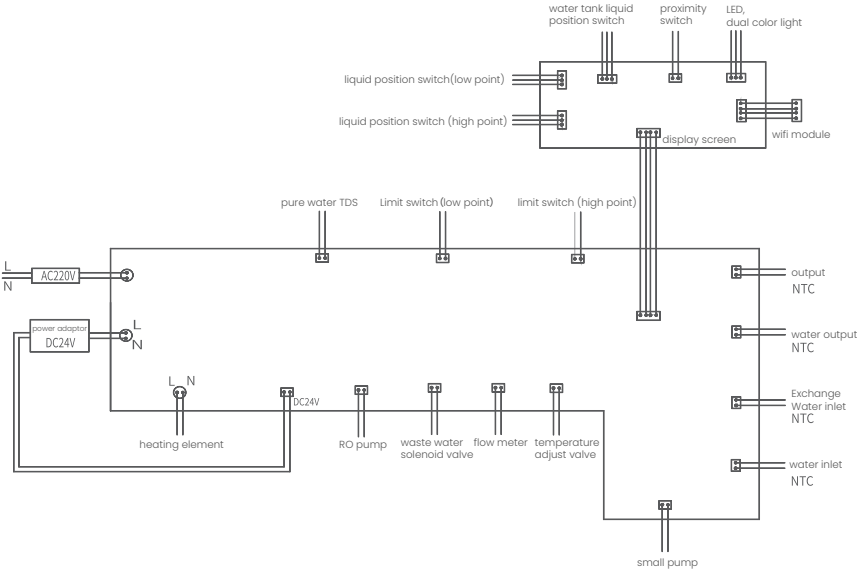

8. PRODUCT PURIFICATION PROCESS

!!Please note: Only fill up the hard water tank with municipal tap water!!

Water Treatment Process and Parameters

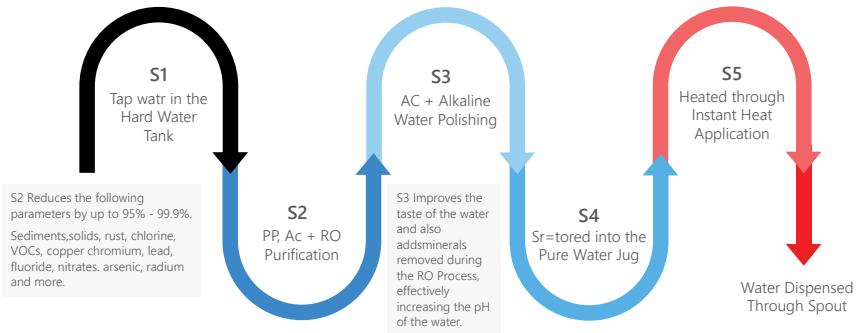

9. IMPORTANT INFORMATION, PLEASE READ

We kindly ask users to follow the setup guidelines detailed in this Instructions Manual and to use the countertop water purifier according to the instructions provided in the manual. By using the Hommix ziRO as recommended in the manual, you can ensure its safe operation. Please note that any damages or water leakage resulting from improper setup or usage are not covered by the company, and we cannot be held responsible for any economic loss or personal injury in such cases.

Please refrain from using this product if:

- If you discover damage to the water purifier.
- Check for a damaged plug or cord.
- Address any continuous overflow issues with the water purifier.
- Periodically inspect power supply and wires for loose or damaged connections to prevent potential electrical accidents.
- Do not attempt to disassemble or modify the water purifier without authorization, as this may lead to malfunctions, water leakage, and property damage.
- Note that warranty does not cover failures resulting from improper use.
- When unplugging, avoid forcefully pulling the power cord.

10. DECLARATION OF CONFORMITY

Product Name/Model: Hommix ziRO Zero Installation Countertop RO System

E: info@hommix.co.uk

T: 0330 113 9292

W: www.hommix.co.uk

WA: +4477 8080 5720

CE Marking 

- EN 60335-1
- EN 60335-2-15
- EN 62233

Environmental Management



- ISO 14001:2015

Quality Management



- ISO 9001:2015

Safety & Quality Assurance



- SGS

Drinking Water Treatment Systems



- NSF/ANSI 58-2019: Reverse Osmosis Drinking Water Treatment Systems (RO Membrane Film)

This Declaration of Conformity certifies that the product specified above complies with the indicated standards and regulations, ensuring its safety, quality, and environmental sustainability. For further details or inquiries, please refer to the user manual or contact our customer support.

11. ERROR CODES AND TROUBLESHOOTING

Error Code	Error	Cause of issue	System Behaviour During Failure	Resolution
E0	Outlet NTC fault	Open or short circuit with the outlet NTC	Hot water will continue working	Turn off, wait 5 seconds and turn on again. If this does not resolve the issue, please contact Place of Purchase
E1	Outlet temperature sensor	Open or short circuit with the thick film NTC	Pure water jug will not fill up	Turn off, wait 5 seconds and turn on again. If this does not resolve the issue, please contact Place of Purchase
E2	Water shortage	The flow meter experiences a water shortage, or the water pump faces a water shortage.	Limited hot water, constant temperature works as normal	Ensure there is water in the Hard Water Tank
E4	Heating element malfunction	More than 10 seconds use without heat module not being active	Device working as normal	Turn off, wait 5 seconds and turn on again. If this does not resolve the issue, please contact Place of Purchase
E5	Hard water too cold	The hard water temperature is below 4°C	Water would not purify	Fill the hard water tank with warm water
E7	Cross circuit malfunction	Power input is not between 220-240V or the mainboard damaged	Heating restricted; continuous temperature water flow permitted	Turn off, wait 5 seconds and turn on again. If this does not resolve the issue, please contact Place of Purchase
EU	Device communication issue	No communication or communication error between the motherboard and the display board	Non-operational	Turn off, wait 5 seconds and turn on again. If this does not resolve the issue, please contact Place of Purchase
EB	Water pump connection issue	Pump connection	Heating restricted; continuous temperature water flow permitted	Turn off, wait 5 seconds and turn on again. If this does not resolve the issue, please contact Place of Purchase
H1	Water inlet temperature sensor failure	Water tank inlet NTC open circuit or short circuit	Permit hot water outlet	Turn off, wait 5 seconds and turn on again. If this does not resolve the issue, please contact Place of Purchase
H2	Voltage sensor failure	Power voltage is outside the range of 160V - 280V	Permit hot water outlet	Once within the required range (220-240V) the system should operate as normal. Otherwise, please contact Place of Purchase
H3	Hot water in the hard water tank	The NTC sensor triggers an alarm above 106°C, allowing cold water discharge. Normal operation resumes when the membrane is 30°C cooler than the inlet temperature.	Heating is not permitted; constant-temperature water flow is allowed.	Ensure the water in the tank is not hot, recommended range is 15-30°C
H4	Extremely hot water in the hard water tank	When NTC temperature sensing on the heating element exceeds 110°C, no water outlet commands are permitted.	Water discharge restricted	Ensure the water in the tank is not hot, recommended range is 15-30°C
H5	Water production timeout	When not in constant use and it has been over 40mins for the tank to fill up	Non-operational	Turn off, wait 5 seconds and turn on again. Otherwise, check that the filters are correctly inserted. If this does not resolve the issue, please contact Place of Purchase

H7	Water Inlet NTC Circuit Issue	Water inlet NTC with an open or short circuit	Permit hot water outlet	Turn off, wait 5 seconds and turn on again. If this does not resolve the issue, please contact Place of Purchase
H8	Liquid level sensor fault	When the RO pump isn't producing water, the small water pump is operational, yet the liquid level sensor remains at full for 60 seconds straight.	Permit water to dispense	Turn off, wait 5 seconds and turn on again. If this does not resolve the issue, please contact Place of Purchase

Fault phenomenon	Possible causes of the malfunction	Troubleshooting
Unable to dispense warm water	The system does not have power	Ensure the system is plugged in and turned on
	Button not pressed properly	Tap the button once more, you should hear a beep. Ensure that the pure water jug has enough water
	Not enough water in the pure water jug	Fill up the hard water tank, wait for the pure water jug to fill up
Unable to dispense hot water	The machine is in "dry heating" state	Initially dispense warm water, then switch to desired hot water temperature
	Not enough water in the pure water jug	Fill up the hard water tank, wait for the pure water jug to fill up
The system does not produce water; pure water jug does not fill	The filter(s) not installed properly	Disconnect the power, remove and reinstall the filters
	There is not enough water in the hard water tank	Fill with tap water upto the "MAX" indication
	The hard water tank is not firmly in place	Please ensure the hard water tank is in place, the lid must be flush with the system
Abnormal sounds during purification	The water is too hard, the CB+RO filter may have been blocked	Replace the CB+RO filter
	The water in the hard water tank is above the maximum limit	Empty some of the water to ensure the water amount is inline with or a little bit less than the MAX limit
The system is leaking	Check valve in hard water tank seat: risk of foreign objects blocking or rushing out	Use a small thimble to reset the check valve to its initial position, or get in touch with the place of purchase for a check valve replacement
	Foreign objects may have jammed the sealing valve located at the bottom of the hard water tank	Press the sealing valve with a small thimble or finger to clear away any foreign objects
	Internal leak	Please empty the hard water tank and pure water jug, turn the device off and contact the place of purchase
	The Pure Water Jug is incorrectly installed, causing it to overflow during the water replenishment process	Lift up the Pure Water Jug and carefully place it into place
There is an abnormal smell in the water	The filters have not been flushed for first time use	Carry out the process in Section 6. 5. a, filling the hard water tank approximately 5 times
	The machine has not been used for a long time	Carry out the process in Section 6. 5. a, filling the hard water tank approximately 5 times
	Filter element not replaced in a timely manner	Please replace the filter(s)
Leakage and induced current on the system body	Poor system grounding	A UK 3-pin socket with grounding must be used
	Damaged power cord	Please contact the place of purchase
No response on the display / buttons	Hardware damage	Please contact the place of purchase
	System failure	Power off the system for approximately 2 mins and then power on again

12. WARRANTY & AFTER SALES

12.1. Elevating Quality Assurance at Hommix UK

At Hommix UK, we take pride in ensuring your peace of mind when it comes to the quality and longevity of our products. Our warranty policy is designed to offer comprehensive coverage and support for your purchased systems across the United Kingdom, Northern Ireland and all countries within the European Union. This warranty takes effect on the date of purchase or, if later, the date of delivery, with proof of purchase serving as a key requirement. It is essential to note that this warranty goes above and beyond your statutory consumer rights.

12.2. The Hommix UK 2-Year Warranty

Our commitment to quality is reflected in our 2-Year Warranty. We stand behind the durability and reliability of our systems, offering repair or replacement of any defective parts within two years of your purchase. To enhance your convenience, we provide free returns for customers within the United Kingdom (mainland). For our valued customers in Northern Ireland and the EU countries, the same service is available, though shipping the system to us is required (free returns are not applicable).

12.3. Ensuring Quality with Replacements

In the rare event that a specific part is no longer available or has gone out of production, Hommix UK retains the right to replace it with a suitable alternative of equal quality.

12.4. Preserve Your Warranty

We kindly request that you refrain from attempting to disassemble the system, as doing so will void your warranty, and any resulting issues or accidents will not be covered by the company. We recommend you keep your sales invoice as a solid proof of purchase.

12.5. Exclusions from Warranty Coverage

It's essential to understand that Hommix UK cannot guarantee the repair or replacement of a product under certain circumstances, including but not limited to:

- **Unauthorised Disassembly:** Attempting system modifications without manufacturer approval.
- **Improper Installation:** Failure to follow provided installation instructions.
- **Non-Approved Parts:** Using unauthorised replacement components.
- **Neglected Maintenance:** Ignoring recommended maintenance tasks.
- **Commercial Use:** Using the system for non-residential purposes.
- **Non-Potable Water:** Using non-approved or low-quality water sources.

- **No Record Keeping:** Failing to register the product or maintain maintenance records.
- **Inadequate Ventilation:** Failing to provide proper ventilation for the system, which can affect its performance and longevity.
- **Overuse or Misuse:** Excessive or improper use of the system, including using it for purposes it wasn't designed for, may result in warranty voidance.

Repairs are free within the warranty period with free shipping within the UK (UK Mainland only)

12.6. Repacking the system for repair

To repack the system, simply follow the instructions below:

1. Remove and empty the pure water into bottles to drink later or put it in the fridge.
2. Remove and empty the hard water tank (this is a good time to clean the tanks and the drip tray).
3. Open the filter cover and remove both of the filters.
4. Lift up the system above the sink and tilt forwards and then upside down to drain the excess water in the filter and tank / jug connections.
5. Dry the system, especially the tank connections and the filter housings, with a clean dry cloth.
6. Only return the system (keep the hard water tank, pure water jug and the drip tray).
7. If you don't have the original packaging, please place it in a reasonable box with padding to avoid any damage.
8. Contact us to arrange a return label (UK Mainland only). If you have purchased from any other country, you will need to arrange delivery to our return address.

12.7. Our Commitment to Service

We go the extra mile to ensure your satisfaction, offering complimentary shipping and free repairs (when the system is sent to us).

Hommix UK is your partner in ensuring the long-lasting performance of your system while maintaining the highest standards of quality and service excellence.

If you require any support, please do not hesitate to contact your local dealer, the company you have purchased your Hommix ziRO from or us directly on:

Web Chat:	https://www.hommix.co.uk
Telephone:	+44 330 113 9292
Mobile / WhatsApp Business:	+44 778080 5720
Email:	cs@hommix.co.uk
Instagram:	hommix.uk
Facebook:	HOMMIXUK

A white HOMMIX water dispenser is the central focus, positioned on a white reflective surface. The dispenser has a digital display on the right side showing '88.8' and several control buttons. A blue light strip is visible on the front panel. In the background, there is a window with white curtains and a green cushion. In the foreground, there is a white plate with cookies and a white cup of coffee on a saucer.

 **HOMMIX**

HOMMIX