

ROCKWELL®

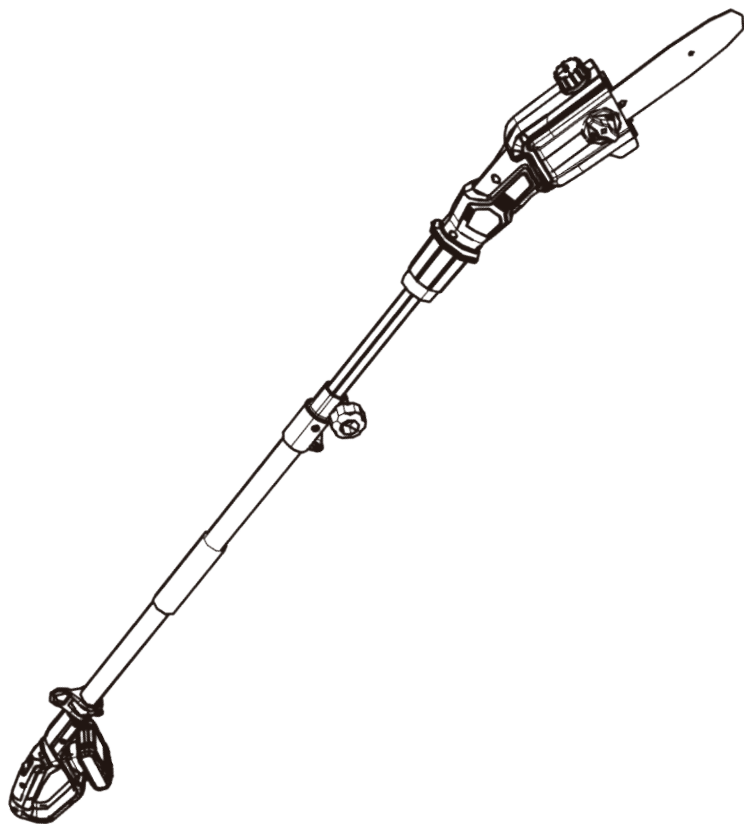

RG8356.9

18V POLE CHAIN SAW

EN

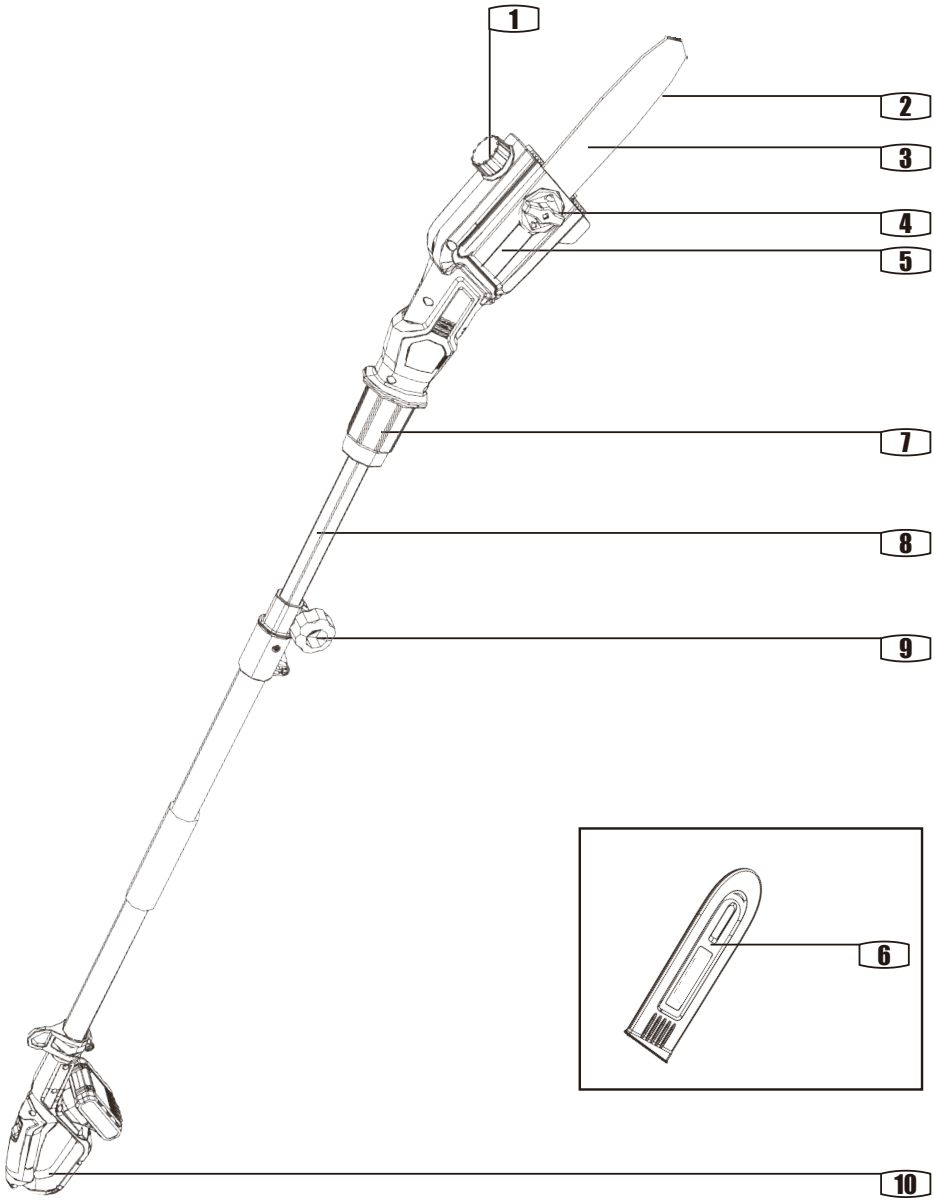

RG8356.9

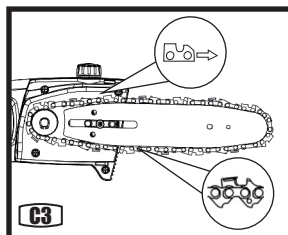
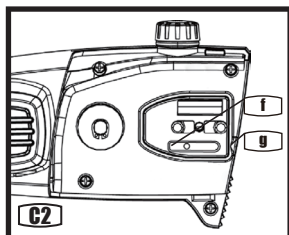
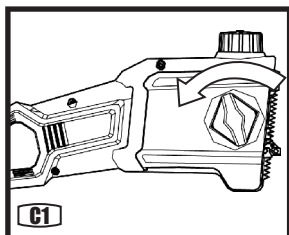
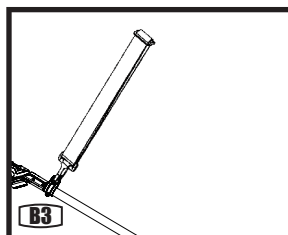
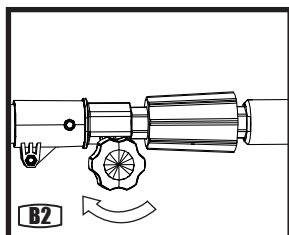
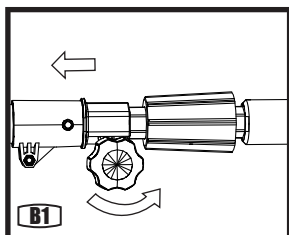
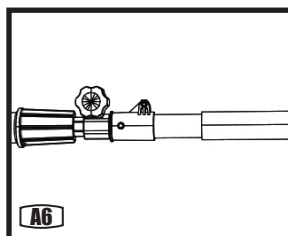
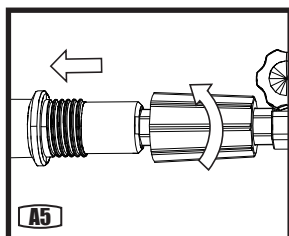
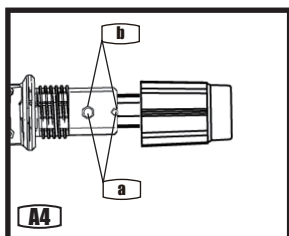
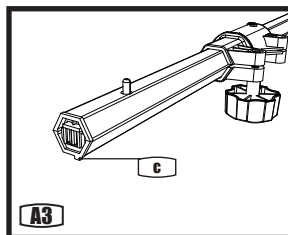
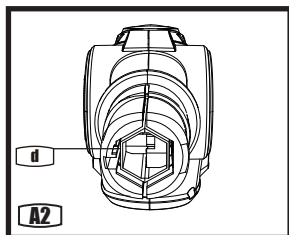
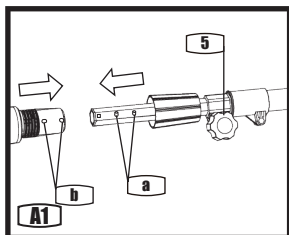

RG8356.9

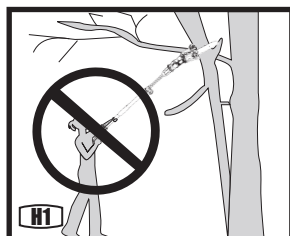
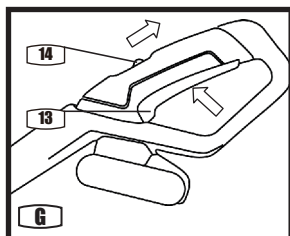
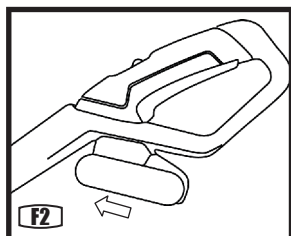
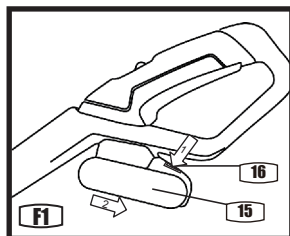
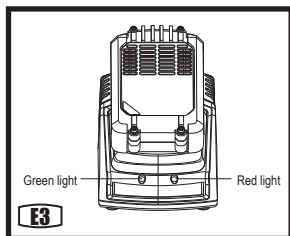
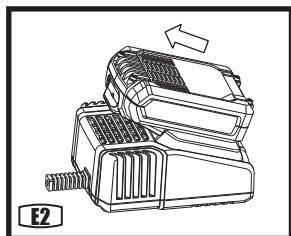
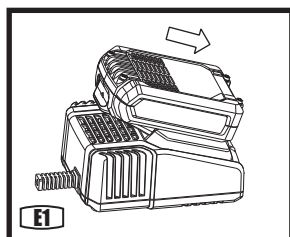
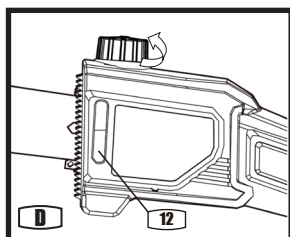
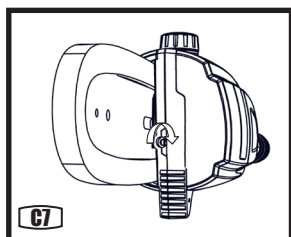
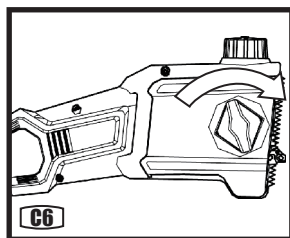
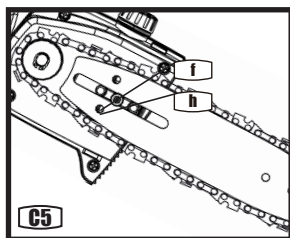
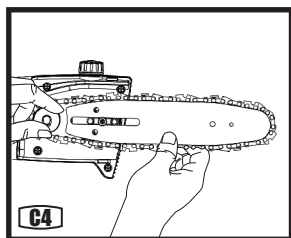

RG8356.9

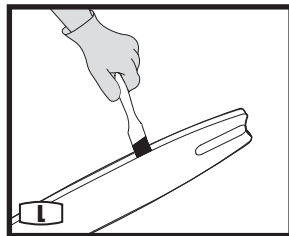
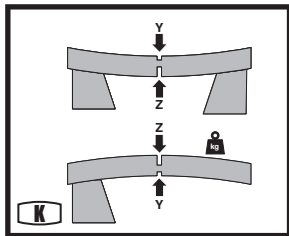
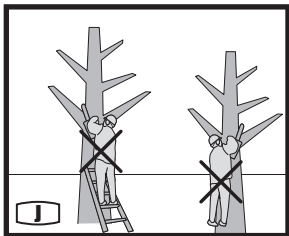
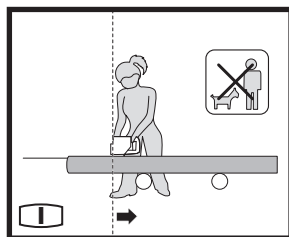
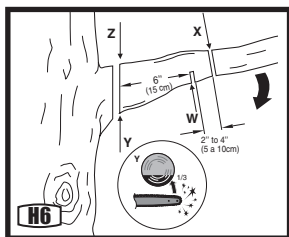
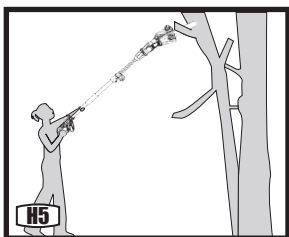
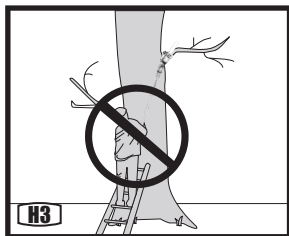

COMPONENT LIST

| | |
|----|--|
| 1 | Oil Filler Cap |
| 2 | Chain |
| 3 | Guide Bar |
| 4 | Chain Tensioning Knob |
| 5 | Chain Cover |
| 6 | Bar And Chain Storage/Transportation Cover |
| 7 | Locking collar |
| 8 | Inner pole |
| 9 | Clamping knob |
| 10 | Rear handle |
| 11 | Shoulder strap |
| 12 | Oil Level Window(See Fig. D) |
| 13 | On/Off Switch(See Fig. G) |
| 14 | Lock-Off Button(See Fig. G) |
| 15 | Battery pack*(See Fig. F1) |
| 16 | Battery pack release button*(See Fig. F1) |

* Not all the accessories illustrated or described are included in standard delivery.

ACCESSORIES

| | |
|--|---|
| Bar And Chain Storage/Transportation Cover | 1 |
| Oregon chain | 1 |
| Oregon bar | 1 |
| Shoulder strap | 1 |

We recommend that you purchase your accessories listed in the above list from the same store that sold you the tool. Refer to the accessory packaging for further details. Store personnel can assist you and offer advice.

PRODUCT SAFETY GENERAL POWER TOOL SAFETY WARNINGS

 **WARNING!** Read all safety warnings and all instructions. Failure to follow the warnings and instructions may result in electric shock, fire and/or serious injury.

Save all warnings and instructions for future reference.

The term "power tool" in the warnings refers to your mains-operated (corded) power tool or battery-operated (cordless) power tool.

1) WORK AREA SAFETY

- a) **Keep work area clean and well lit.** Cluttered or dark areas invite accidents.
- b) **Do not operate power tools in explosive atmospheres, such as in the presence of flammable liquids, gases or dust.** Power tools create sparks which may ignite the dust or fumes.
- c) **Keep children and bystanders away while operating a power tool.** Distractions can cause you to lose control.

2) ELECTRICAL SAFETY

- a) **Power tool plugs must match the outlet. Never modify the plug in any way. Do not use any adapter plugs with earthed (grounded) power tools.** Unmodified plugs and matching outlets will reduce risk of electric shock.
- b) **Avoid body contact with earthed or grounded surfaces, such as pipes, radiators, ranges and refrigerators.** There is an increased risk of electric shock if your body is earthed or grounded.
- c) **Do not expose power tools to rain or wet conditions.** Water entering a power tool will increase the risk of electric shock.
- d) **Do not abuse the cord. Never use the cord for carrying, pulling or unplugging the power tool. Keep cord away from heat, oil, sharp edges or moving parts.** Damaged or entangled cords increase the risk of electric shock.
- e) **When operating a power tool outdoors, use an extension cord suitable for outdoor use.** Use of a cord suitable for outdoor use reduces the risk of electric shock.
- f) **If operating a power tool in a damp location is unavoidable, use a residual current device (RCD) protected supply.** Use of an RCD reduces the risk of electric shock.

3) PERSONAL SAFETY

- a) **Stay alert, watch what you are doing and use common sense when operating a power tool. Do not use a power tool while you are tired or under the influence of drugs, alcohol or medication.** A moment of inattention while operating power tools may result in serious personal injury.
- b) **Use personal protective equipment. Always wear eye protection.** Protective equipment such as dust mask, non-skid safety shoes, hard hat, or hearing protection used for appropriate conditions will reduce personal injuries.

- c) **Prevent unintentional starting. Ensure the switch is in the off-position before connecting to power source and/or battery pack, picking up or carrying the tool.** Carrying power tools with your finger on the switch or energising power tools that have the switch on invites accidents.
- d) **Remove any adjusting key or wrench before turning the power tool on.** A wrench or a key left attached to a rotating part of the power tool may result in personal injury.
- e) **Do not overreach. Keep proper footing and balance at all times.** This enables better control of the power tool in unexpected situations.
- f) **Dress properly. Do not wear loose clothing or jewellery. Keep your hair, clothing and gloves away from moving parts.** Loose clothes, jewellery or long hair can be caught in moving parts.
- g) **If devices are provided for the connection of dust extraction and collection facilities, ensure these are connected and properly used.** Use of these devices can reduce dust-related hazards.

4) POWER TOOL USE AND CARE

- a) **Do not force the power tool. Use the correct power tool for your application.** The correct power tool will do the job better and safer at the rate for which it was designed.
- b) **Do not use the power tool if the switch does not turn it on and off.** Any power tool that cannot be controlled with the switch is dangerous and must be repaired.
- c) **Disconnect the plug from the power source and/or the battery pack from the power tool before making any adjustments, changing accessories, or storing power tools.** Such preventive safety measures reduce the risk of starting the power tool accidentally.
- d) **Store idle power tools out of the reach of children and do not allow persons unfamiliar with the power tool or these instructions to operate the power tool.** Power tools are dangerous in the hands of untrained users.
- e) **Maintain power tools. Check for misalignment or binding of moving parts, breakage of parts and any other condition that may affect the power tool's operation. If damaged, have the power tool repaired before use.** Many accidents are caused by poorly maintained power tools.
- f) **Keep cutting tools sharp and clean.** Properly maintained cutting tools with sharp cutting edges are less likely to bind and are easier to control.

g) **Use the power tool, accessories and tool bits etc. in accordance with these instructions, taking into account the working conditions and the work to be performed.** Use of the power tool for operations different from those intended could result in a hazardous situation.

5) BATTERY TOOL USE AND CARE

- a) **Recharge only with the charger specified by the manufacturer.** A charger that is suitable for one type of battery pack may create a risk of fire when used with another battery pack.
- b) **Use power tools only with specifically designated battery packs.** Use of any other battery packs may create a risk of injury and fire.
- c) **When battery pack is not in use, keep it away from other metal objects, like paper clips, coins, keys, nails, screws or other small metal objects, that can make a connection from one terminal to another.** Shorting the battery terminals together may cause burns or a fire.
- d) **Under abusive conditions, liquid may be ejected from the battery; avoid contact. If contact accidentally occurs, flush with water. If liquid contacts eyes, additionally seek medical help.** Liquid ejected from the battery may cause irritation or burns.

6) SERVICE

- a) **Have your power tool serviced by a qualified repair person using only identical replacement parts.** This will ensure that the safety of the power tool is maintained.

CHAIN SAW SAFETY WARNINGS

- Keep all parts of the body away from the saw chain when the chain saw is operating. Before you start the chain saw, make sure the saw chain is not contacting anything.** A moment of inattention while operating chain saws may cause entanglement of your clothing or body with the saw chain.
- Always hold the chain saw with your right hand on the rear handle and your left hand on the front handle.** Holding the chain saw with a reversed hand configuration increases the risk of personal injury and should never be done.
- Hold the power tool by insulated gripping surfaces only, because the saw chain may contact hidden wiring.** Saw chains contacting a "live" wire may make exposed metal parts of the power tool "live" and

could give the operator an electric shock.

- Wear safety glasses and hearing protection. Further protective equipment for head, hands, legs and feet is recommended.** Adequate protective clothing will reduce personal injury by flying debris or accidental contact with the saw chain.
- Do not operate a chain saw in a tree.** Operation of a chain saw while up in a tree may result in personal injury.
- Always keep proper footing and operate the chain saw only when standing on fixed, secure and level surface.** Slippery or unstable surfaces such as ladders may cause a loss of balance or control of the chain saw.
- When cutting a limb that is under tension be alert for spring back.** When the tension in the wood fibres is released the spring loaded limb may strike the operator and/or throw the chain saw out of control.
- Use extreme caution when cutting brush and saplings.** The slender material may catch the saw chain and be whipped toward you or pull you off balance.
- Carry the chain saw by the front handle with the chain saw switched off and away from your body. When transporting or storing the chain saw always fit the guide bar cover.** Proper handling of the chain saw will reduce the likelihood of accidental contact with the moving saw chain.
- Follow instructions for lubricating, chain tensioning and changing accessories.** Improperly tensioned or lubricated chain may either break or increase the chance for kickback.
- Keep handles dry, clean, and free from oil and grease.** Greasy, oily handles are slippery causing loss of control.
- Cut wood only. Do not use chain saw for purposes not intended. For example: do not use chain saw for cutting plastic, masonry or non-wood building materials.** Use of the chain saw for operations different than intended could result in a hazardous situation.

CAUSES AND OPERATOR PREVENTION OF KICKBACK:

Kickback may occur when the nose or tip of the guide bar touches an object, or when the wood closes in and pinches the saw chain in the cut. Tip contact in some cases may cause a sudden reverse reaction, kicking the guide bar up and back

towards the operator.

Pinching the saw chain along the top of the guide bar may push the guide bar rapidly back towards the operator.

Either of these reactions may cause you to lose control of the saw which could result in serious personal injury. Do not rely exclusively upon the safety devices built into your saw. As a chain saw user, you should take several steps to keep your cutting jobs free from accident or injury.

Kickback is the result of tool misuse and/or incorrect operating procedures or conditions and can be avoided by taking proper precautions as given below:

-Maintain a firm grip, with thumbs and fingers encircling the chain saw handles, with both hands on the saw and position your body and arm to allow you to resist kickback forces. Kickback forces can be controlled by the operator, if proper precautions are taken. Do not let go of the chain saw.

-Do not overreach and do not cut above shoulder height.

This helps prevent unintended tip contact and enables better control of the chain saw in unexpected situations.

-Only use replacement bars and chains specified by the manufacturer. Incorrect replacement bars and chains may cause chain breakage and/or kickback.

-Follow the manufacturer's sharpening and maintenance instructions for the saw chain.

Decreasing the depth gauge height can lead to increased kickback.

FOR CHAIN SAW WITH THE EXTENDED POLE SAFETY WARNINGS

1. Do not use the machine when the operator is tired, ill or under the influence of alcohol or other drugs.
2. To reduce the risk, please keep bystanders at a safe distance from the machine during its operation.
3. Be aware of the dangers of operating positions, the operator may be struck by falling branches or by those that rebound after hitting the ground. Remove the branches in sections.
4. Keep a firm footing and balance during operating. Use the harness provided.
5. Keep the machine a sufficient distance away from overhead electrical power lines.

SAFETY WARNINGS FOR BATTERY PACK

- a) **Do not dismantle, open or shred cells or battery pack.**
- b) **Do not short-circuit a battery pack. Do not store battery packs haphazardly in a box or drawer where they may short-circuit each other or be short-circuited by conductive materials.** When battery pack is not in use, keep it away from other metal objects, like paper clips, coins, keys, nails, screws or other small metal objects, that can make a connection from one terminal to another. Shorting the battery terminals together may cause burns or a fire.
- c) **Do not expose battery pack to heat or fire. Avoid storage in direct sunlight.**
- d) **Do not subject battery pack to mechanical shock.**
- e) **In the event of battery leaking, do not allow the liquid to come into contact with the skin or eyes. If contact has been made, wash the affected area with copious amounts of water and seek medical advice.**
- f) **Seek medical advice immediately if a cell or battery pack has been swallowed.**
- g) **Keep battery pack clean and dry.**
- h) **Wipe the battery pack terminals with a clean dry cloth if they become dirty.**
- i) **Battery pack needs to be charged before use. Always refer to this instruction and use the correct charging procedure.**
- j) **Do not maintain battery pack on charge when not in use.**
- k) **After extended periods of storage, it may be necessary to charge and discharge the battery pack several times to obtain maximum performance.**
- l) **Battery pack gives its best performance when it is operated at normal room temperature (20 °C ± 5 °C).**
- m) **When disposing of battery packs, keep battery packs of different electrochemical systems separate from each other.**
- n) **Recharge only with the charger specified by POSITEC. Do not use any charger other than that specifically provided for use with the equipment.** A charger that is suitable for one type of battery pack may create a risk of fire when used with another battery pack.
- o) **Do not use any battery pack which is not designed for use with the equipment.**
- p) **Keep battery pack out of the reach of children.**

- q) Retain the original product literature for future reference.
- r) Remove the battery from the equipment when not in use.
- s) Dispose of properly.

SAVE THESE INSTRUCTIONS

Instructions concerning the proper techniques for basic felling, limbing, and cross-cutting

1. Felling a tree

When bucking and felling operations are being performed by two or more persons at the same time, the felling operations should be separated from the bucking operation by a distance of at least twice the height of the tree being felled. Trees should not be felled in a manner that would endanger any person, strike any utility line or cause any property damage. If the tree does make contact with any utility line, the company should be notified immediately.

The chain saw operator should keep on the uphill side of the terrain as the tree is likely to roll or slide downhill after it is felled.

An escape path should be planned and cleared as necessary before cuts are started. The escape path should extend back and diagonally to the rear of the expected line of fall as illustrated in Figure 1.

Before felling is started, consider the natural lean of the tree, the location of larger branches and the wind direction to judge which way the tree will fall.

Remove dirt, stones, loose bark, nails, staples and wire from the tree.

2. Notching undercut

Make the notch 1/3 the diameter of the tree, perpendicular to the direction of falls as illustrated in Figure 1. Make the lower horizontal notching cut (W) first. This will help to avoid pinching either the saw chain or the guide bar when the second notch (X) is being made.

3. Felling back cut

Make the felling back cut (Y) at least 50 mm higher than the horizontal notching cut as illustrated in Figure 1. Keep the felling back cut parallel to the horizontal notching cut. Make the felling back cut so enough wood is left to act as a hinge. The hinge wood keeps the tree from twisting

and falling in the wrong direction. Do not cut through the hinge.

As the felling gets close to the hinge, the tree should begin to fall. If there is any chance that the tree may not fall in desired direction or it may rock back and bind the saw chain, stop cutting before the felling back cut is complete and use wedges of wood, plastic or aluminium (Z) to open the cut and drop the tree along the desired line of fall ().

When the tree begins to fall remove the chain saw from the cut, stop the motor, put the chain saw down, then use the retreat path planned (). Be alert for overhead limbs falling and watch your footing.

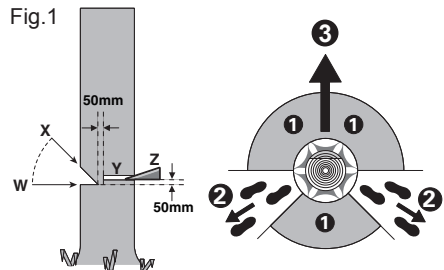

4. Limbing a tree

Limbing is removing the branches from a fallen tree. When limbing leave larger lower limbs to support the log off the ground. Remove the small limbs in one cut as illustrated in Figure 2. Branches under tension should be cut from the bottom up to avoid binding the chain saw.

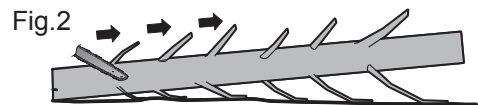

5. Bucking a log

Bucking is cutting a log into lengths. It is important to make sure your footing is firm and your weight is evenly distributed on both feet. When possible, the log should be raised and supported by the use of limbs, logs or chocks. Follow the simple directions for easy cutting.

When the log is supported along its entire length as illustrated in Figure 3, it is cut from the top (overbuck), avoid contacting ground as this will greatly reduce the chain sharpness.

Fig.3

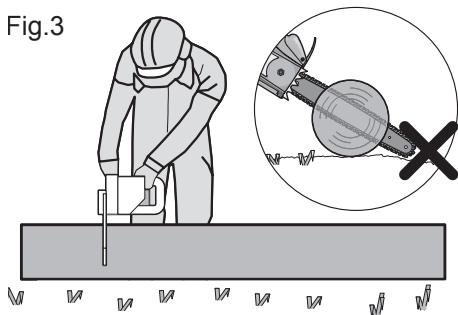

When the log is supported on one end, as illustrated in Figure 4, cut 1/3 the diameter from the underside (underbuck) (1). Then make the finished cut by overbucking (2) to meet the first cut.

Fig.4

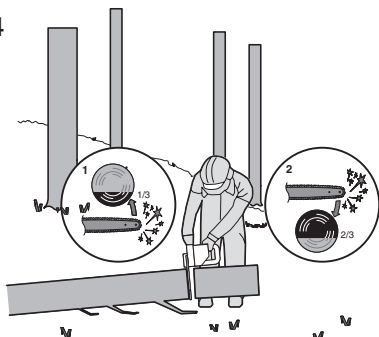

When the log is supported on both ends, as illustrated in Figure 5, cut 1/3 the diameter from the top (overbuck) (1). Then make the finished cut by underbucking (2) the lower 2/3 to meet the first cut.

Fig.5

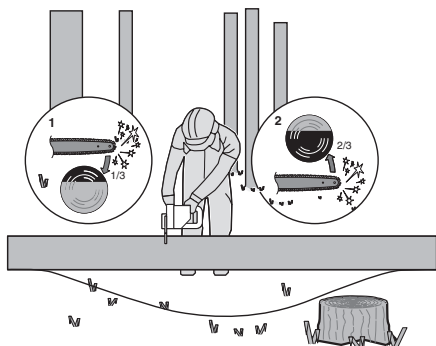

When bucking on a slope always stand on the uphill side of the log, as illustrated in Figure 6. When "cutting through", to maintain complete control release the cutting pressure near the end of the cut without relaxing your grip on the chain saw handles. Don't let the chain contact the ground. After completing the cut, wait for the saw chain to stop before you move the chain saw. Always stop the motor before moving from tree to tree.

Fig.6

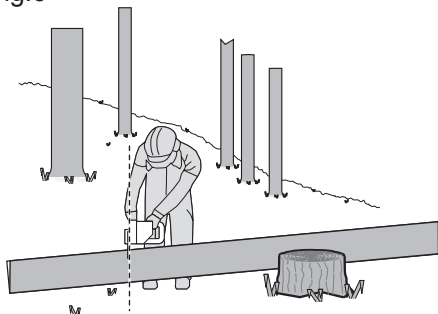

GENERAL SAFETY WARNINGS FOR CHARGER

WARNING Read all safety warnings and all instructions. Failure to follow the warnings and instructions may result in electric shock, fire and/or serious injury.

Save all warnings and instructions for future reference.

- This appliance is not intended for use by persons (including children) with reduced physical, sensory or mental capabilities, or lack of experience and knowledge, unless they have been given supervision or instruction concerning use of the appliance by a person responsible for their safety.

- Children should be supervised to ensure that they do not play with the appliance.

If the supply cord is damaged, it must be replaced by the manufacturer, its service agent or similarly qualified persons in order to avoid a hazard.

ADDITIONAL SAFETY INSTRUCTIONS FOR YOUR BATTERY CHARGER

1. Before charging, read the instructions.
2. For charge Li-ion battery pack only.
3. Do not charge a leaking battery.

4. Do not use chargers for works other than those for which they are designed.
5. Before charging, ensure your charger matches the local AC supply.
6. The charging device must be protected from moisture.
7. Do not use the charging device in the open.
8. Do not short out the contacts of battery or charger.
9. Respect the polarity “+/-“ when charging.
10. Do not open the unit and keep out of the reach of children.
11. Do not charge the batteries of other manufactures or ill-suited models.
12. Ensure that the connection between the battery charger and battery is correctly positioned and is not obstructed by foreign bodies.
13. Keep battery charger’s slots are free of foreign objects and protect against dirt and humidity. Store in a dry and frost-free place.
14. When charging batteries, ensure that the battery charger is in a well-ventilated area and away from inflammable materials. Batteries can get hot during charging. Do not overcharge any batteries. Ensure that batteries and chargers are not left unsupervised during charging.
15. Do not recharge non-rechargeable batteries, as they can overheat and break.
16. Longer life and better performance can be obtained if the battery pack is charged when the air temperature is between 18°C and 24°C. Do not charge the battery pack in air temperatures below 4.5°C, or above 40.5°C. This is important as it can prevent serious damage to the battery pack.
17. Charge only battery packs of the same model provided by POSITEC and of models recommended by POSITEC.



Do not expose to rain



Li-Ion battery. This product has been marked with a symbol relating to ‘separate collection’ for all battery packs . It will then be recycled or dismantled in order to reduce the impact on the environment. Battery packs can be hazardous for the environment and for human health since they contain hazardous substances.



Do not burn



Batteries may enter water cycle if disposed improperly, which can be hazardous for ecosystem. Do not dispose of waste batteries as unsorted municipal waste.



Wear head protection



Wear protective gloves



Wear protective footwear

SYMBOLS



To reduce the risk of injury, user must read instruction manual



Wear ear protection



Wear eye protection



Wear dust mask



Warning of danger from overhead electric-power lines



For indoor use only (for charger)





Read the operator's manual (for charger)



Fuse





Positive terminal

| | |
|--|---------------------------------|
|  | Negative terminal |
|  | Double insulation (for charger) |
|  | RCM marking |

ABN: Australian Business Number. By this number, business information such as entity type, status, business location etc. can be found at website <http://abr.business.gov.au>.
ABN of Positec Australia Pty Limited is 14 101 682 357

TECHNICAL DATA

| | | |
|-------------------------------|---|---------|
| Rated Voltage | 18V  | |
| Bar length: | 20 cm | |
| Chain speed | 3.8 m/s | |
| Oil tank capacity | 80 ml | |
| Chain pitch | 9.5 mm | |
| Charger model | RW9897 | |
| Charger input | 100-240V ~ 50/60Hz, 70W | |
| Charger output | 20V , 2.5A | |
| Charger protection class |  / II | |
| Battery type | Li-Ion | |
| Battery model | RW9894/RW9906 | |
| Charging time (approx.) | 2.0 Ah | 55 min |
| | 4.0 Ah (RW9906) | 105 min |
| Weight(chain & bar included) | 2.78 kg | |

NOTE:

- The accessories of battery charger (RW9897) and battery pack (RW9894 / RW9906) illustrated or described are not included in RG8356.9 delivery.
- Charging time may change a little bit due to various charging situations.

ASSEMBLY

 **WARNING! Do not insert the battery pack to the machine before it is completely assembled.**
Always use gloves when handling the chain.

TO ASSEMBLE THE POLE (SEE FIG. A1-A6)

- Loosen the clamping knob (9) by turning it anti-clockwise. Extend the pole to expose the two small cylinders (a). Turn the clamping knob (9) clockwise to lock the pole to avoid pole movement while assembling.
- Align and insert the extended pole into the machine head.

NOTE:

- The two cylinders (a) on the pole should be inserted exactly into the two small holes (b) of the machine head. (See Fig. A1, A4)
 - The bulge (c) at the end of the pole should be exactly inserted into the hole (d) inside the machine head. (See Fig. A2, A3)
 - Tighten the sleeve (e) securely by turning clockwise.
- NOTE:** Make sure that the sleeve is firmly tightened in place. (See Fig. A6)

 **WARNING!**

- Before assembling the extension pole to the machine, make sure that the tool is switched off and the battery pack has been removed.**
- When using this machine with the Extension Pole, make sure to first insert the battery pack.**
- ELECTROCUTION HAZARD:**
Never use the Saw or Extension Pole in an area with overhead power lines or where the branch being cut can come into contact with overhead power lines.

ADJUSTING POLE LENGTH

The pole saw has a telescoping pole assembly that will extend from 90cm (fully retracted) to 140cm (fully extended).

A clamping knob (9) is used to hold the pole in position at any extended length.

- To extend the pole, firstly loosen the knob and then pull inner pole section out to desired length of extension as shown in Fig.B1. Pole will slide freely.
Note: Only extend pole to minimum length required to reach limb that is being cut.
- To lock pole in position, tighten the knob clockwise as shown in Fig.B2.

TO ASSEMBLE THE SHOULDER STRAP (SEE FIG B3)

Your pole hedge trimmer is supplied with a shoulder strap.

The shoulder strap is supplied with a quick release hook. Connect the hook to the bracket of machine body located before the handle.

TENSIONING CHAIN

NOTE: New saw chains will stretch. Check the chain tension frequently when first used and tighten the chain when the Chain becomes loose around the Guide Bar.

**WARNING:**

- **Remove the battery pack before adjusting saw chain tension.**
- **Cutting edges on chain are sharp. Use protective gloves when handling chain.**
- **Maintain proper chain tension always. A loose chain will increase the risk of kickback. A loose chain may jump out of guide bar groove. This may injure operator and damage chain. A loose chain will cause chain, bar, and sprocket to wear rapidly.**

1. Unpack all parts carefully. Place the chain saw on a solid, level surface.
2. Remove the chain tensioning knob by turning it counter-clockwise, and remove the chain cover. (See C1, C2)
Note: At this time, observe the rod (f) on the machine to check if it is too close to the left. If yes, you can use the provided spanner to tighten the screw hole (g) by turning it clockwise to make the rod close to the right. It will save your effort while tensioning the chain (Step 6).
3. Slide the chain in the slot around the guide bar. Ensure the chain is in correct running direction by comparing it to the chain icon on the guide bar, or referring to the chain direction symbol found on the saw body. (See Fig. C3)
4. Fit the chain onto the saw body. Assure all parts are seated properly and drive links are fully seated in the drive sprocket (See Fig. C4).

NOTE: The hole of the guide bar (h) should be exactly placed on to the rod of the machine (f).

NOTE: Chain should rotate freely and be free of kinks.

5. Fit the chain cover (5) and tighten it by turning the chain tensioning knob (4) clockwise until it is tight. (See Fig. C6)
6. Use the provided spanner to slightly tighten the screw hole by turning it clockwise to tension the chain. (See Fig. C7)

LUBRICATION

Important: The chain saw is not supplied filled with oil. It is essential to fill with oil before use. Never operate the chain saw without chain oil or with an empty oil tank, as this will result in extensive damage to the product.

NOTE: Chain life and cutting capacity depend on optimum lubrication. Therefore, the chain is automatically oiled during operation.

Filling oil tank:

1. Set chain saw on any suitable surface with Oil Filler Cap facing upward.
2. Clean area around the Oil Filler Cap with cloth and unscrew the cap by turning it counter clockwise. (See Fig. D)
3. Add bar and chain oil until reservoir is full.
4. Avoid dirt or debris entering oil tank, refit Oil Filler Cap and tighten by turning clockwise until hand tight.



Important: To allow venting of the oil reservoir, small breather channels are provided between the Oil Filler Cap and the strainer, to prevent leakage ensure machine is left in a horizontal position (Oil Filler Cap uppermost) when not in use.

It is important to use only the recommended oil (ISO VG32) to avoid damage to the chain saw. Never use recycled/old oil. Use of non approved oil will invalidate the warranty.

Checking the Automatic Oiler

Proper functioning of the automatic oiler can be checked by running the chain saw and pointing the tip of the Guide chain bar towards a piece of cardboard or paper on the ground. If an increasing oil pattern develops on the cardboard, the automatic oiler is operating fine. If there is no oil pattern, despite a full oil reservoir, contact POSITEC customer service agent or POSITEC approved service agent.



Caution: Do not touch the ground with the chain. Ensure safety clearance of 12”.

OPERATION**BEFORE PUTTING INTO OPERATION****CHARGING YOUR BATTERY PACK (See Fig. E1, E2, E3)**

Do not use any charger other than that specifically

provided for use with the equipment.

If the battery pack is very hot you must remove your battery pack from the charger and allow time for the battery to cool down before recharging. Please charge the battery to reach full before storage. If the tool will not be used for long periods of time, charge the battery every 3 months.

Charging procedure

- 1) Plug the charger into an appropriate outlet. The light will be green.
- 2) Slide the battery pack into the charger, make sure the battery is in the correct charge position firmly, the light will turn to red to indicate the charging process has started.
- 3) When charging is completed, the light will turn to green.
- 4) After fully charged, unplug the charger and remove the battery pack.



NOTE:

If the battery pack is locked in the charger, press the battery pack release button and remove it.



WARNING: When battery charge runs out after continuous use or exposure to direct sunlight or heat, allow time for the tool to cool down before re-charging to achieve the full charge.

Charging indicator

| Light | ON/OFF flash | Status |
|--|--------------|---------------|
| Red on ●  | ————— | Charging |
| Green on ●  | ————— | Fully Charged |

NOTE: Battery charger (RW9897) and battery pack (RW9894 / RW9906) illustrated or described are not included in RG8356.9 delivery.

TO REMOVE OR INSTALL BATTERY PACK (See Fig. F1, F2) (battery not supplied)

Depress the Battery Pack Release Button and remove the Battery Pack from your tool. After recharging, insert the Battery Pack into the battery port. A simple push and slight pressure will be sufficient until a click is heard. Check to see if the battery is fully secured.

Note: When removing the battery pack, hold it firmly to avoid dropping and injury.

SWITCHING ON AND OFF (SEE FIG. G)



Attention: Check the voltage and current supply: The voltage and current supply must comply with the ratings on the product plate.

For **switching on** the tool, press the Lock-off Button, then fully press the On/Off Switch and hold in this position. The Lock-Off Button can now be released. For **switching off**, release the On/Off Switch.

CUTTING WITH EXTENSION POLE

1. Insert the battery pack.



WARNING: Do not stand directly below a branch being cut. Keep bystanders far away. Do not stand on a ladder or other type of unstable support while using the tool. Do not use the tool near cable, electrical power or telephone lines. Keep 10 ft (3m) away from all power lines. (See Fig. H1-H4)

2. Use both hands to grip Pole Saw. Use only designated grip areas when operating Pole Saw. Use firm grip. Thumbs and fingers must wrap around Pole Saw handle and pole. (See Fig. H5)
3. Make sure your footing is firm. Keep feet apart. Divide your weight evenly on both feet.
4. When ready to make a cut, press the Lock-off Button, then fully press the On/off Switch. This will turn Pole Saw on. Releasing On/off Switch will turn Pole Saw off. Make sure saw is running at full speed before starting a cut.
5. When starting a cut, place moving chain against wood. Hold Pole Saw firmly in place to avoid possible bouncing or skating (sideways movement) of saw.
6. Guide Pole Saw using light pressure. Do not force Pole Saw. The motor will overload and can burn out. It will do the job better and safer at the rate for which it was intended.
7. Remove Pole Saw from a cut with saw running at full speed. Stop Pole Saw by releasing trigger. Make sure chain has stopped before setting Pole Saw down.

TRIMMING A TREE (PRUNING)

WARNING: Avoid kickback. Kickback can result in severe injury or death.

See Kickback, to avoid risk of kickback.

WARNING: Do not operate Pole Saw while

- in a tree
- on a ladder or any other unstable surface
- in any awkward position

You may lose control of Pole Saw causing severe

injury.



WARNING: Do not extend arms above shoulders when using Pole Saw.

CAUTION: Seek professional help if facing conditions beyond your ability.

Trimming a tree is the process of cutting limbs from a living tree. Make sure your footing is firm. Keep feet apart. Divide your weight evenly on both feet. Follow directions below to trim a tree.

1. Make first cut six inches from tree trunk on underside of limb. Use top of guide bar to make this cut. Cut 1/3 through diameter of limb (See Figure H6).
2. Move two to four inches farther out on limb. Make second cut from above limb. Continue cut until you cut limb off.
3. Make third cut as close to tree trunk as possible on underside of limb stub. Use top of guide bar to make this cut. Cut 1/3 through diameter of stub.
4. Make fourth cut directly above third cut. Cut down to meet third cut. This will remove limb stub.

Kickback Safety Devices On This Saw

This saw has a low-kickback chain and reduced kickback Guide Bar. Both items reduce the chance of kickback. However, kickback can still occur with this saw.

The following steps will reduce the risk of kickback. Use both hands to grip saw while saw is running. Use firm grip. Thumbs and fingers must wrap around saw handles.

- Keep all safety items in place on saw. Make sure they work properly.
- Do not overreach or cut above shoulder height.
- Keep solid footing and balance at all times.
- Stand slightly to left side of saw. This keeps your body from being in direct line with chain.
- Do not let Guide Bar nose touch anything when chain is moving.
- Never try cutting through two logs at same time. Only cut one log at a time.
- Do not bury the Guide Bar nose or try plunge cut (boring into wood using Guide Bar nose).
- Watch for shifting of wood or other forces that may pinch chain.
- Use extreme caution when reentering a previous cut.
- Use only the low-kickback chain and Guide Bar that were supplied with this chain saw.
- Never use a dull or loose chain. Keep chain sharp with proper tension.

How to use Saw Safely

1. Use the chain saw only with secure footing.
2. Hold the chain saw at the right-hand side of your body (See Fig. I).
3. The Chain must be running at full speed before it makes contact with the wood.
4. Do not operate the chain saw with arms fully extended, attempt to saw areas which are difficult to reach, or stand on a ladder while sawing (see Fig. J). **Never use the chain saw above shoulder height**

Cutting wood under tension (See fig. K)



WARNING: When cutting a limb that is under tension, use extreme caution. Be alert for wood springing back. When wood tension is released, limb could spring back and strike operator causing severe injury or death.

When sawing logs supported on both ends, start the cut from above(Y) about 1/3 of the diameter into the log (overbuck) and then finish the cut (Z) from below, in order to avoid contact of the chain saw with the ground. When sawing logs supported on only one end, start the cut from below (Y) about 1/3 of the diameter into the log (underbuck) and finish the cut from above (Z) in order to avoid log splitting or jamming of the chain saw.

SAW MAINTENANCE

Follow maintenance instructions in this manual. Proper cleaning of saw and chain and Guide Bar maintenance can reduce chances of kickback. Inspect and maintain saw after each use. This will increase the service life of your saw.

Note: Even with proper sharpening, risk of kickback can increase with each sharpening.

MAINTENANCE AND STORAGE OF CHAIN SAW

1. Remove the battery pack
 - When not in use
 - Before moving from one place to another
 - Before servicing
 - Before changing accessories or attachments, such as saw chain and guard
2. Inspect chain saw before and after each use. Check saw closely if guard or other part has been damaged. Check for any damage that may affect operator safety or operation of saw. Check for

alignment or binding of moving parts. Check for broken or damaged parts. Do not use chain saw if damage affects safety or operation. Have damage repaired by authorized service center.

3. Maintain chain saw with care.
 - Never expose saw to rain.
 - Keep chain sharp, clean, and lubricated for better and safer performance.
 - Follow steps outlined in this manual to sharpen chain.
 - Keep handles dry, clean, and free of oil and grease.
 - Keep all screws and nuts tight.
4. When servicing, use only identical replacement parts.
5. When not in use, always store chain saw
 - in a high or locked place, out of children's reach
 - in a dry place

Bar Maintenance

To maximize bar life, the following bar maintenance is recommended.

The bar rails that carry the chain should be cleaned before storing the tool or if the bar or chain appear to be dirty.

The rails should be cleaned every time the chain is removed.

Turn the bar over, top rail becoming bottom and bottom rail becoming top, around every 5 hours of use

To clean the Bar rails:

1. Remove chain cover and bar and chain.
2. Using a wire brush, screwdriver or similar tool, clear the residue from the inner groove of the bar. (See Fig. L)
3. Make sure to clean oil passages thoroughly

Conditions which require Guide Bar maintenance:

- Saw cuts to one side or at an angle.
- Saw has to be forced through the cut.
- Inadequate supply of oil to the bar and chain.

Check the condition of the Guide Bar each time the chain is sharpened. A worn Guide Bar will damage the chain and make cutting difficult.

After each use, remove battery pack and clean all sawdust from the Guide Bar and sprocket hole.

When rail top is uneven, use a flat file to restore square edges and sides.

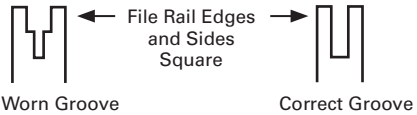

Replace the Guide Bar when the groove is worn, the Guide Bar is bent or cracked, or when excess heating or burring of the rails occurs. If replacement is necessary, use only the Guide Bar specified for your saw in the repair parts list or on the decal located on the chain saw.

TROUBLESHOOTING TABLE

The following table gives checks and actions that you can perform if your machine does not operate correctly. If these do not identify/remedy the problem, contact your service agent.



WARNING: Switch off and remove the battery pack before investigating fault.

| Symptom | Possible Cause | Remedy |
|---|---|---|
| Chain saw fails to operate | Flat or discharged battery | Charge the battery pack. Replace fuse. |
| Chain saw operates intermittently | Loose connection. Internal wiring defective. On/Off switch defective. | Contact service agent |
| Dry chain | No oil in reservoir Vent in oil filler cap clogged Oil passage clogged | Refill oil Clean cap Clean oil passage outlet |
| Chain/chain bar over-heats | No oil in reservoir Vent in oil filler cap clogged Oil passage clogged Chain is over tensioned Dull chain | Refill oil Clean cap Clean oil passage outlet Adjust chain tension Sharpen chain or replace |
| Chain saw rips, vibrates, does not saw properly | Chain tension too loose Dull chain Chain worn out Chain teeth are facing in the wrong direction | Adjust chain tension Sharpen chain or replace Replace chain Reassemble with chain in correct direction |



POSITEC AUSTRALIA PTY LTD
ABN 14 101 682 357

MADE IN PRC