

LOCKLY Enjoy the freedom™

FLEX TOUCH

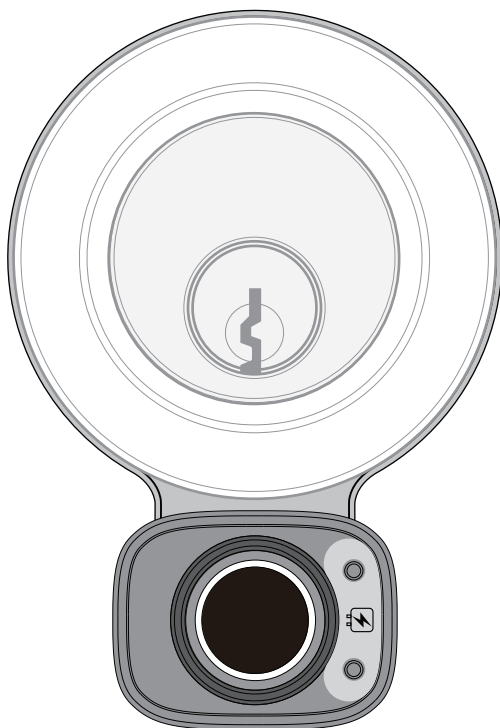

USER MANUAL

PGD7A | PGD7AW

Table of Contents

Section 1 - Product Highlights

1.1	Product Features	1
-----	------------------	---

Section 2 - Product Overview

2.1	Product Overview - Exterior	2
2.2	Product Overview - Interior	3
2.3	Getting the Most From Your Lockly	4
2.4	Pair Lock with Lockly App	5
2.5	Resetting Your Lock	6
2.6	Low Battery	7
2.7	Changing the Battery	8

Section 3 - Using Your Smart Lock

3.1	Adding a Fingerprint	9
3.2	Fingerprint Scanning Directions	12
3.3	Deleting Stored Fingerprints	13
3.4	Adding Optional Secure Link	14

Section 4 - Locking and Unlocking

4.1	Locking/Unlocking Lockly with Fingerprints	15
4.2	Locking/Unlocking Lockly with App	16
4.3	Locking/Unlocking Lockly with Physical Key	17
4.4	Unlock with QR Code	17
4.5	Locking and Unlocking with Voice Assistant	18
4.6	Rain Mode	19
4.7	Welcome Mode	20

Section 5 - Advanced Features

5.1	eBadge	21
-----	--------	----

Section 6 - Important Notes	23
------------------------------------	----

Section 7 - Cleaning Tips	24
----------------------------------	----

Section 8 - Safety Precautions	25
---------------------------------------	----



For additional support scan
or visit [Lockly.com/help](https://www.Lockly.com/help)
or email help@Lockly.com

*Requires optional Secure Link Wi-Fi Hub (sold separately - www.Lockly.com)

1.1 Product Features

Advanced 3D Fingerprint Recognition

Biometric Fingerprint Recognition protocol stores up to 99 unique fingerprints. Accepts only actual fingerprints (no copies or lifted prints) for extra security.

Auto Lock Feature

Never worry that you forgot to lock your door. Custom auto lock feature can be set to automatically lock 5 seconds up to 5 minutes after unlocking, making sure your door is always secure.

External Battery Backup

Open with access externally with emergency power backup via 9V battery that attaches to external contacts and your registered fingerprint.

Access Profile Duplication

Allows time saving, secure copying and pasting through the Lockly app of duplicate fingerprint and eKey profiles from one lock to another lock.

Multi-door Locking Mode

Easily program all your Lockly smart locks to lock simultaneously with one touch using the Lockly app, Amazon Alexa or Google Assistant.*

SmartSync Monitoring

Check real-time* door status and access history on your smartphone with Lockly mobile app or through Lockly\OST™ online tool anytime, from anywhere.

2.1 Product Overview - Exterior

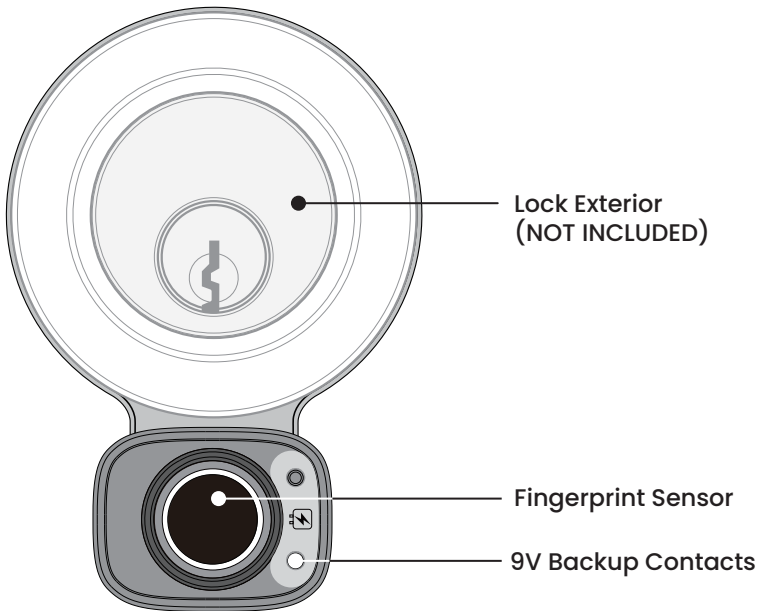

2.2 Product Overview - Interior

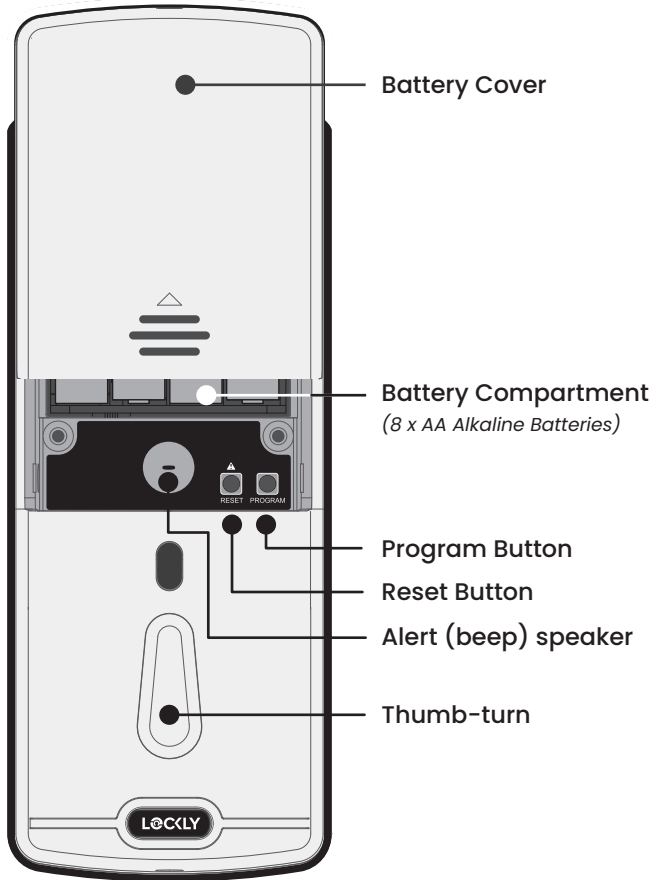

2.3 Getting the Most From Your Lockly

Thanks for purchasing your new Lockly. To get the most out of your lock be sure to read completely through this manual to learn all of its features and capabilities.

Lockly smart locks are at their full potential when used with the free Lockly app. Be sure to download to take advantage of all of the connected features.

If you have any questions or need help contact customer care at help@Lockly.com or online [Lockly.com/help](https://www.lockly.com/help)

To speak to a customer care representative, call (669) 500 – 8835 Monday to Friday, from 11 AM to 7 PM PST.

You can also send an email to help@Lockly.com

Get the Free App
scan or visit
[Lockly.com/app](https://www.lockly.com/app)

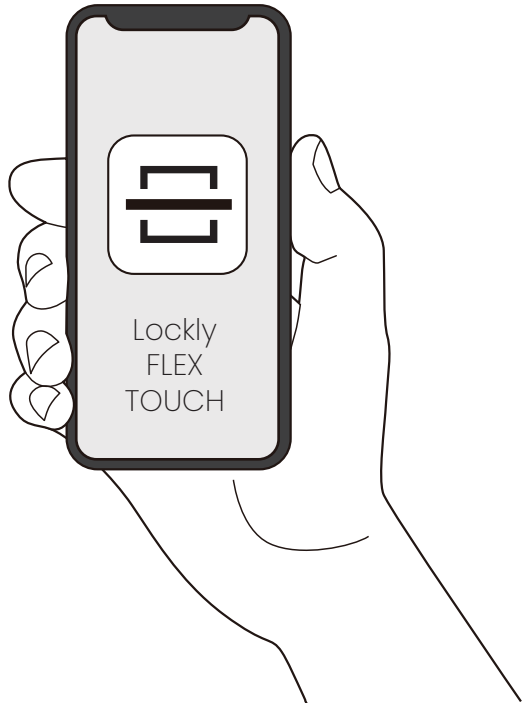

2.4 Pair Lock with the Lockly App

To pair your lock with the free Lockly mobile app, you must have your **Activation Code** available. The **Activation Code** is specific to your lock and is located on the **Activation Code Card** included with your smart lock.



 **The Activation Code is unique to each specific lock. DO NOT LOSE IT. Keep it in a safe place, as you will not be able to re-pair or reset your lock without it.**

1. If you have not, download the Lockly app from the App Store or on Google Play.
2. Open the App and create an account, or log into your existing account.

IMPORTANT:

Make sure the Bluetooth on your phone is ON and you **ALLOW** Lockly to use **Bluetooth**. Go to your phone Settings and look for the **Lockly app** to make sure the Bluetooth is allowed to pair with Lockly.

3. Select set up a new device.
4. Stand within Bluetooth range (10/ft or less) of lock and choose lock model you wish to pair.
5. Choose the lock you wish to pair (e.g. Lockly Flex Touch) and select Get Started.

Continue to follow on-screen instruction to complete pairing and set-up.

2.5 Resetting Your Lock

In order to restore your lock to factory default settings, you must have your “**Activation Code**” available. The **Activation Code** is specific to your lock and is located on the **Activation Code Card** included with your smart lock, see page (5).

To reset, push the reset button located under the battery cover, in the lower right corner. **WARNING:** once the smart lock has been reset, all previously stored data will be deleted.

To add your lock to the mobile app have your activation code available and refer to “Pair Lock with Lockly app” on page 5.

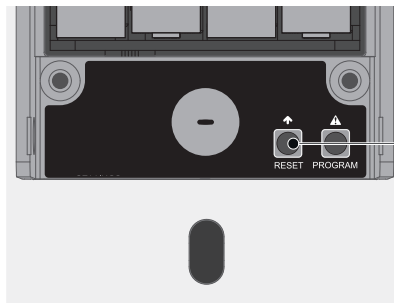

Reset Button

Under battery cover

Press **Reset Button for one (1) second or till you hear a short beep**

See page 5 for **re-pairing** your lock to the Lockly app

2.6 Low Battery Alert

Lockly Flex Touch will notify you with a continuous beep that it's time to change the batteries before they reach critical level. You should replace the batteries **immediately** to avoid the lock from shutting down and auto locking.

If you do not change the batteries after hearing the low battery warning alert beeps, the alert will eventually stop. You will then have 3 chances to unlock using your fingerprint. If unlocking was successful, the low battery warning alert will come back on for one minute. The lock will then auto-lock (within 5 seconds) and return to low battery mode.

Condition	Indicator	Solution
Low Battery	Low battery warning alert (continuous beep).	Replace batteries immediately to avoid battery failure. Lock may still operate for a short period (up to 300 cycles) in low battery condition.
Dead Battery	When there is no alarm sound (continuous beep) and fingerprint access is non-functional.	Replace batteries immediately. Supplied physical backup keys can be used to unlock the door. Alternatively, use a 9V battery as shown below to temporarily activate the lock.

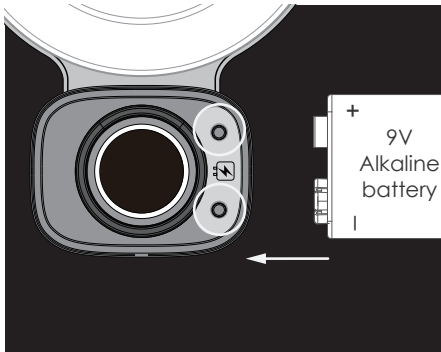

Hold a 9V alkaline battery against the contact points located at the bottom front side of the lock hold to activate the fingerprint reader and scan **a registered fingerprint** to unlock. Once unlocked, replace batteries immediately.

2.7 Changing Batteries

Under normal use, batteries can last up to a year. Check batteries **regularly** and change right away when the low battery alarm notification is heard. As a best practice, always use new, major brand, **alkaline batteries**.

Open the battery compartment cover by unscrewing the screw located on the top of the cover and sliding the cover up. Install eight (8) new AA alkaline batteries as shown. Reinstall cover and tighten screw.

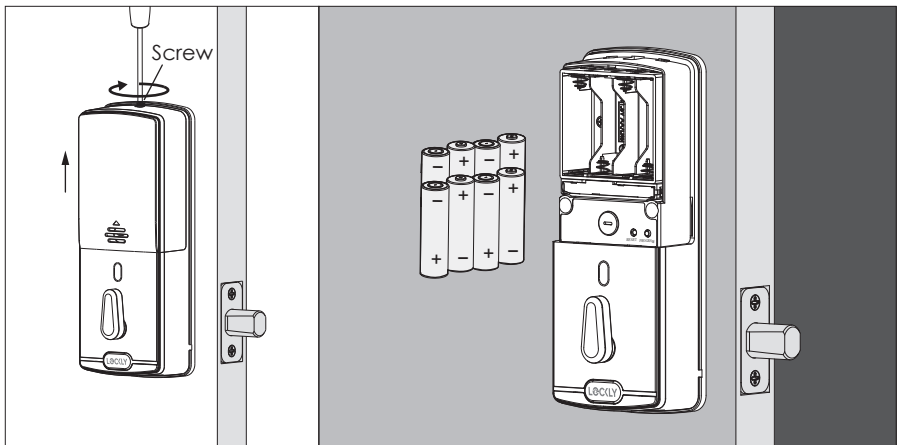

- Make sure the batteries are correctly oriented.
- Replacement of batteries does not affect programmed data.
- Replace only with new batteries. DO NOT mix with used batteries.



Whenever batteries are replaced, reconnecting the smart lock to your smartphone app is required. To download the app, visit: [Lockly.com/app](https://lockly.com/app)

3.1 Adding a Fingerprint

Lockly Flex Touch can store up to 99 fingerprints. Fingerprints are added and registered using the free Lockly app for iOS or Android. Download the Lockly app from the App Store or on Google Play then register a new fingerprint under Access > Fingerprint and follow the on-screen prompts.

Lockly uses an advanced biometric sensor, providing the most secure fingerprint authentication. For security reasons, the sensor only accepts fingerprint patterns that consist of cross intersection points. Patterns with no cross intersection points are not acceptable.

TIP: check your fingers before registration to make sure the finger you want to register will be acceptable. If not, use an alternate finger to ensure successful registration. The following examples show which types of fingerprint patterns are acceptable. It is highly recommended to enroll at least one finger from each hand in case the hand you are using is unavailable, (e.g., holding items in that hand or finger is injured and/or covered).

Fingerprint pattern with cross intersection lines



OK

Concentric or parallel pattern with no cross intersection lines

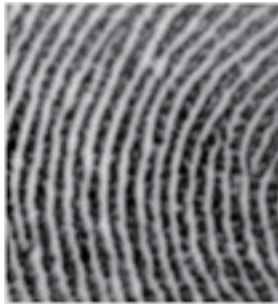

Not OK

Fingerprint with scars or worn out ridges



Not OK

3.1 Adding a Fingerprint (Continued)



Make sure fingers and sensor are clean and free of dirt, oil, water, sweat, or any other moisture or foreign material. Sensor can be cleaned by wiping with a lint-free microfiber cloth.

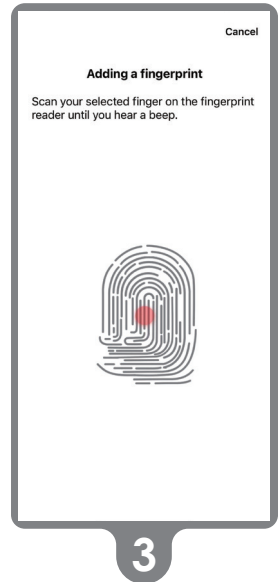
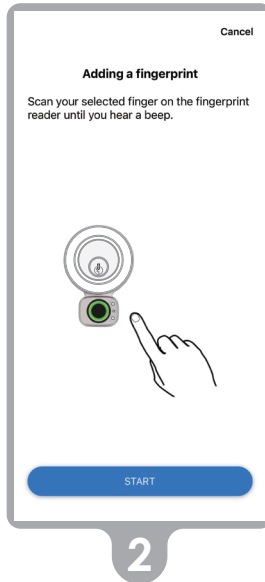

- 1 On the Lockly app, select the Lockly Flex Touch you wish to add a fingerprint. Go to Access > Access Management > Access > Fingerprint.
- 2 Select the finger you wish to register and tap "Start."
- 3 Scan your selected finger until you hear a beep indicating your fingerprint has been successfully registered.

Continued...

3.1 Adding a Fingerprint (Continued)

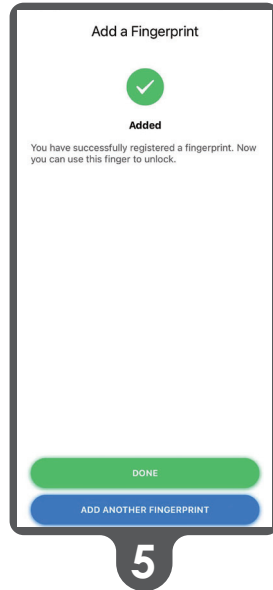
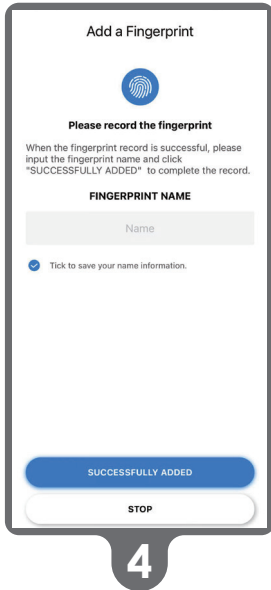

- 4 Enter a Fingerprint name to save the profile, then tap "Successfully Added".
- 5 Tap "Add Another Fingerprint" to register additional fingers or tap "Done".

TIP: Scan the same finger more than once to increase accuracy.

3.2 Fingerprint Scanning

Lockly fingerprint sensors use powerful fingerprint reading algorithms that are able to detect most fingerprints accurately and quickly, even in less than ideal conditions. Knowing how to place your finger on the sensor correctly helps with consistent and fast recognition.

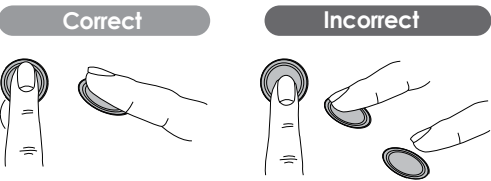
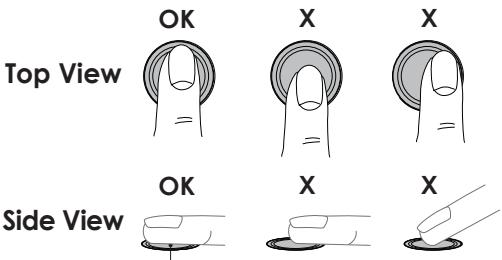
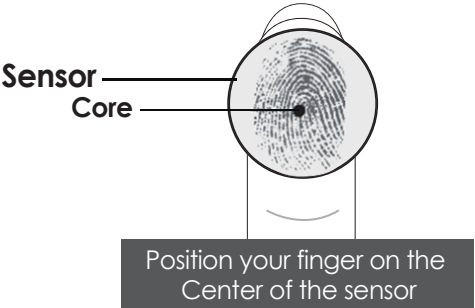
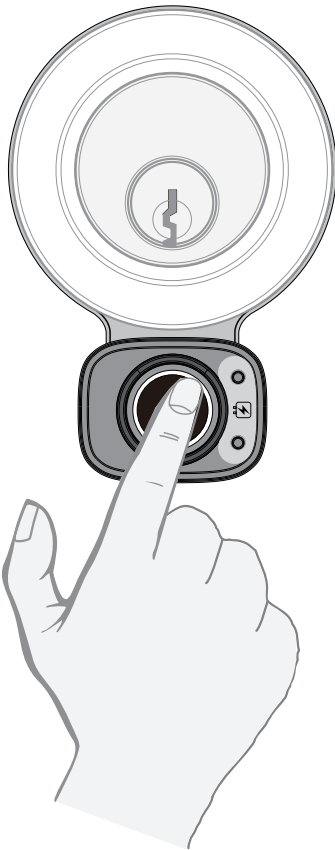

3.3 Deleting Fingerprints

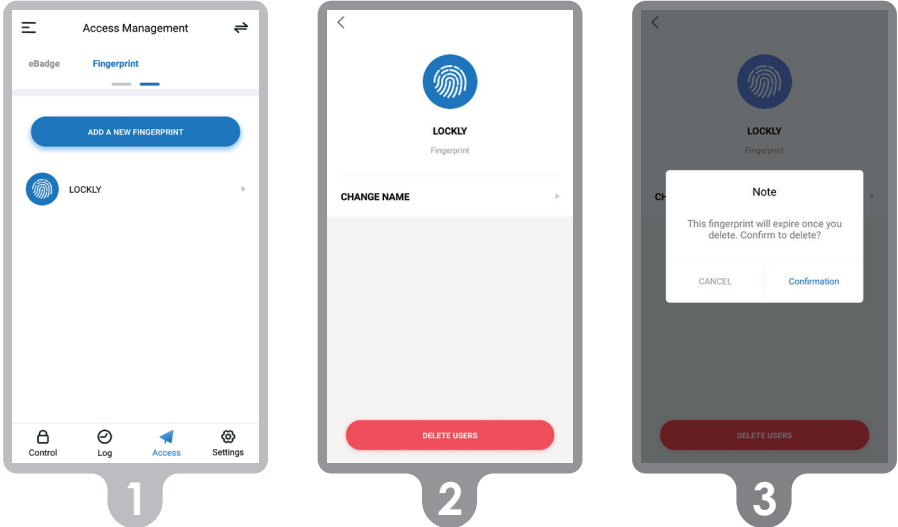

- 1 On the Lockly app, select the Lockly Flex Touch you wish to delete a fingerprint on. Go to Access Management > Fingerprint. Select the fingerprint by name you wish to delete.
- 2 Select [DELETE USER] at bottom.
- 3 Confirm. Once a registered fingerprint has been deleted it cannot be recovered. You will need to re-register the finger as a new fingerprint to restore.

3.4 Adding Optional Secure Link Wi-Fi hub

Add Wi-Fi capability by adding the Lockly Secure Link Wi-Fi Hub. Securely control and manage your door from anywhere, anytime. Remotely lock or unlock, check door status, grant guest eKeys, Offline Access Codes™, and see who's coming and going, all from the convenience of your smartphone. The hub also enables voice control allowing you to use your Alexa or Google Assistant-enabled devices.

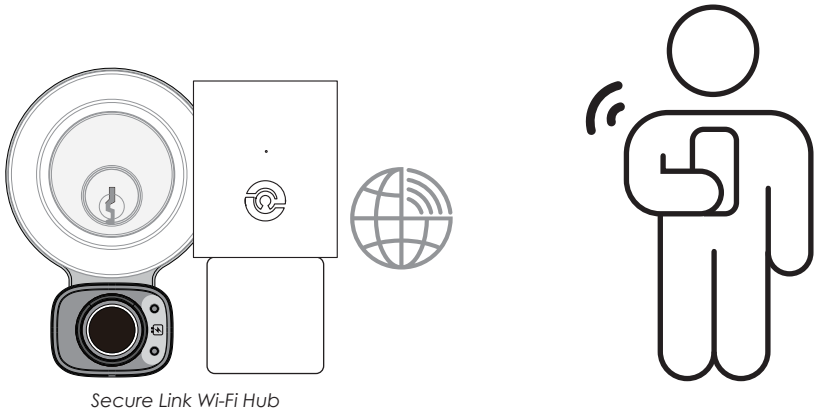

Secure Link Wi-Fi Hub

To set up the Lockly Secure Link and Door Sensor, launch the Lockly App, from the main menu drop down located on the upper left of the screen, select "Add a New Device" then select "Secure Link Wi-Fi Hub". Follow the in-app instructions. To activate voice commands, you will need the Google Home Assistant or Amazon Alexa device with Actions (Google) and Skill (Amazon) added before you can configure voice commands.

Available online at: [Lockly.com/hub](https://lockly.com/hub)

4.1 Locking/Unlocking with Finger

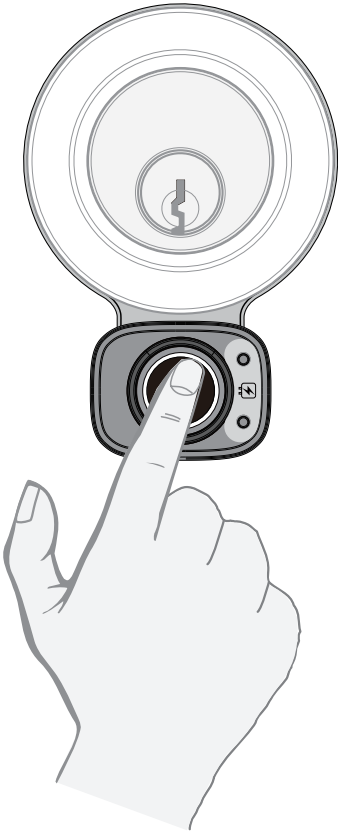

Unlocking

Place a registered finger (to register see section 3.1) .

to the fingerprint scanner on the low exterior of the lock.

If your fingerprint is acknowledged, you will hear a “beep” a green LED will light, and the deadbolt will unlock.

If you see a red LED, it means your fingerprint is not recognized. Wait until the red LED turns off, then try again.

See Section 3.2. for tips on best fingerprint scanning practices.

Locking

To lock, press the fingerprint sensor anytime when the door is closed.

4.2 Locking/Unlocking with App

Open the Lockly app and select your lock (e.g., Lockly Flex Touch) tap the lock or unlock icon.

You will also need the app in order to lock and unlock with Amazon Alexa or Google Assistant. To download, visit the link below or search "Lockly" in the App Store or on Google Play.



Scan or visit
[Lockly.com/app](https://lockly.com/app)

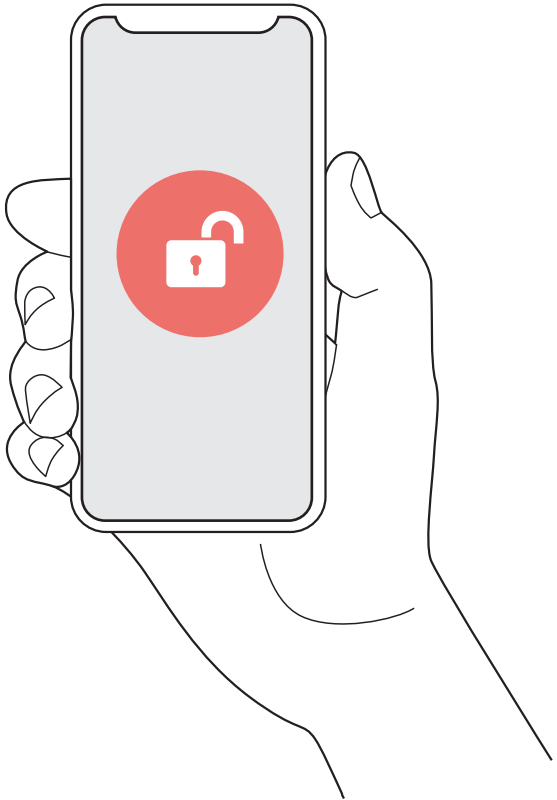

4.3 Locking/Unlocking with Physical Key

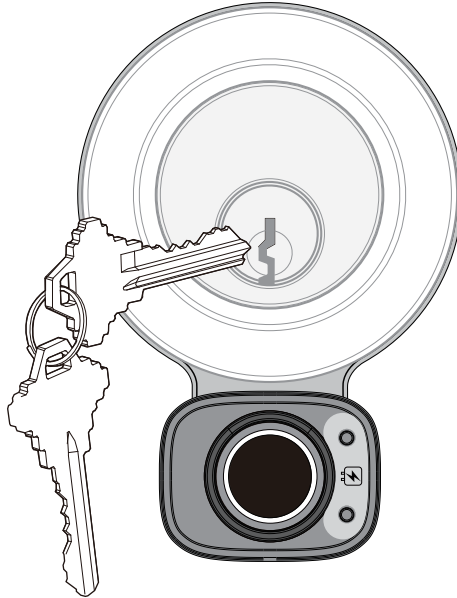

Lockly Flex Touch is designed to convert your existing deadbolt to a smart lock and keep your existing physical keys. To unlock your lock using your physical key, insert key and turn clockwise or counterclockwise to lock or unlock the door.

4.4 Unlock with QR Code

If you have multiple Lockly door locks, you can use the Lockly app code scanner to unlock.

A QR code sticker (blue color) comes together with your lock. Open the Lockly app and scan it to unlock. You may also generate a unique QR code via Lockly app for your smart lock.

You can generate QR code, print according to the size you want and stick it next to your door.

4.5 Locking and Unlocking with Voice Assistants

Lockly Flex Touch can be used with your Amazon Alexa or Google Assistant-enabled devices with the addition of the optional Lockly Secure Link Wi-Fi Hub. Once installed and configured properly to your lock, make sure you enable the Lockly Action on Google or the Amazon Alexa Skill before performing voice commands.

Once configured, you can ask questions such as door status or requests for your door to be locked or unlocked.

EXAMPLES:



- "Hey Google, unlock the Back Door"
- "Hey Google, is the Back Door locked?"
- "Hey Google, lock the Back Door"
- "Hey Google, is the Back Door unlocked?"

Pre-setup is required in the Google Home app in order for these queries to work. The user would need to name the lock "Back Door" or as appropriate.



- Alexa, unlock my Front Door.*
- Alexa, is my Front Door locked?
- Alexa, lock my Front Door.
- Alexa, is my Front Door unlocked?

*Unlock requests require additional voice security codes that can be configured in the Lockly app settings.

4.6 Rain Mode

To protect the lock and extend battery life, Lockly Flex Touch automatically enters Rain Mode whenever rain or water is detected on the fingerprint sensor for more than 45 seconds. When Rain Mode is activated, the fingerprint sensor will not respond. **The lock automatically exits rain mode every 30 minutes** and only reenters if rain or water is still detected. See below for ways to access during Rain Mode.

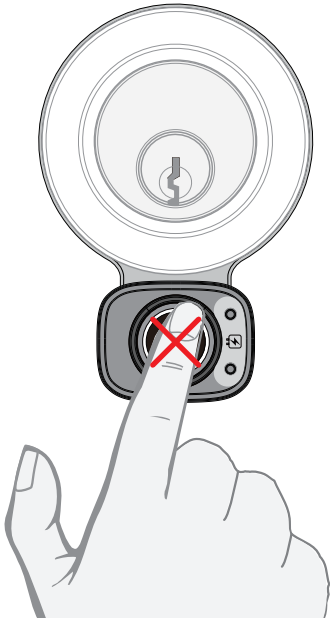

ACCESS DURING RAIN MODE

1. Unlock using the Lockly app
2. Unlock with physical key

RAIN MODE ACTIVATED
fingerprint sensor disabled

NOTE: when the lock enters Rain Mode, it's recorded in the log history on the Lockly app. The app will also send a push notification to your mobile phone letting you know that the lock is in Rain Mode.

4.7 Welcome Mode

Welcome Mode temporarily disables auto locking, keeping the door open for a specified period of time eliminating the need for fingerprint key access.

Enable this feature through the Lockly App. Go to > **Settings** > **Enable Welcome Mode**, then slide button to enable and set the specific time you require your door unlocked.

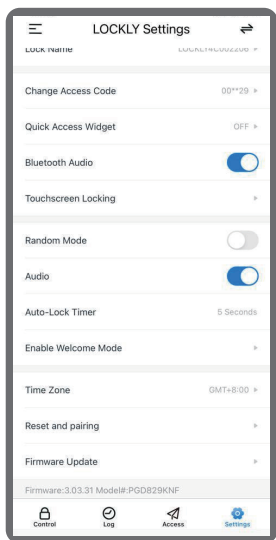

1

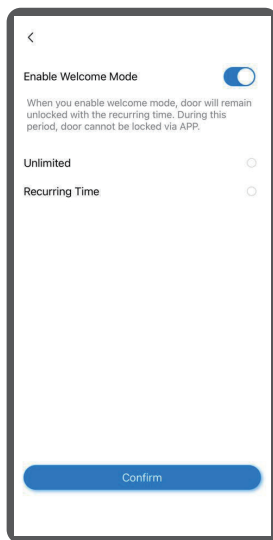

2



NOTICE

To ensure Welcome Mode works normally after replacing the battery, reconnect the lock to the Lockly app to synchronize the time.

5.1 eBadge

An eBadge is a unique code that can be issued to another user giving them door access for a specific reoccurring time frame or a valid period of time. It requires them to download the free Lockly app and access can only be gained through the app (not the fingerprint reader).

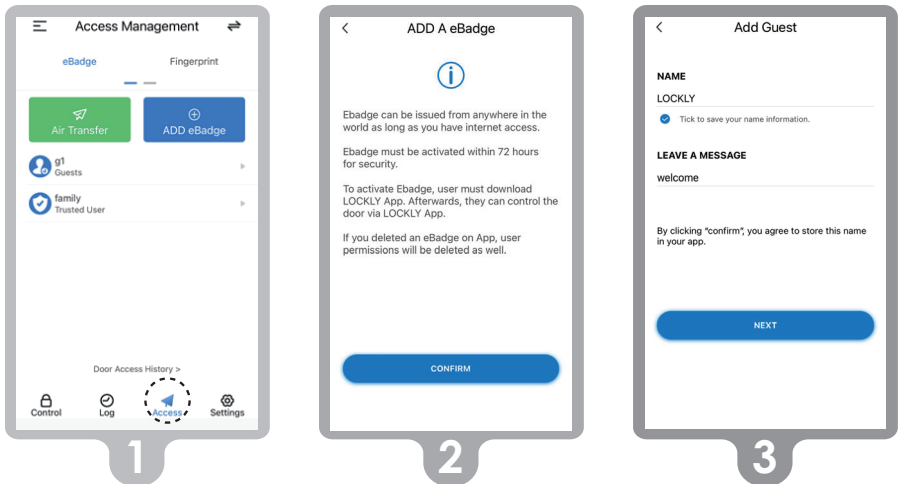

- 1 To set up and send a code in the Lockly app, go to > Access > eBadge (at top) > Add eBadge, then follow the on-screen prompts.
- 2 Confirm you want to add an eBadge.
- 3 Give the eBadge name you will recognize. Provide a custom message that will be sent to the user.

5.1 eBadge (Continued)

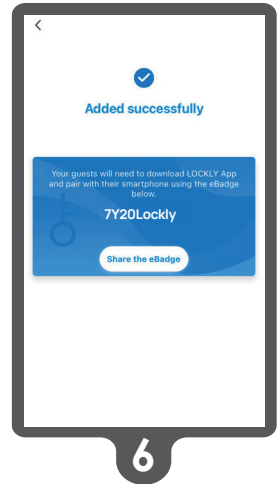
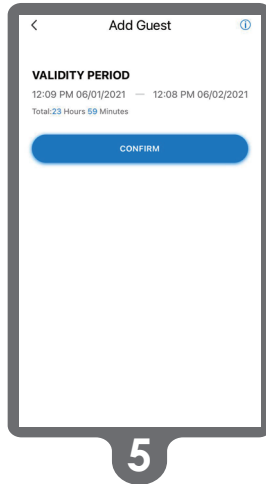
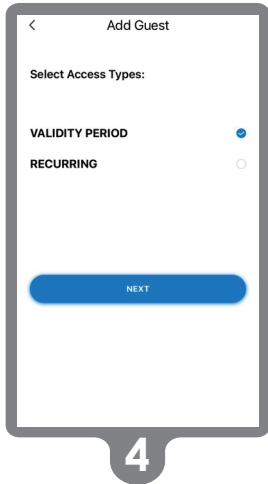

- 4 Select type of access: either a valid period of time or ongoing recurring (can be revoked at anytime).
- 5 Review and confirm access type.
- 6 Share unique eBadge code.

6.1 Important Notes

Troubleshooting

Please visit [Lockly.com/help](https://www.Lockly.com/help) for troubleshooting and the most frequently asked questions and answers.

Auto Lock Feature

Your lock can be programmed to auto-lock between 5-300 seconds after the door opening. You can select the timing through the Lockly App.

9V Backup Access

When your Lockly is out of power, you can temporarily activate the fingerprint sensor by using a 9V battery against the bottom of the exterior side of the smart lock. Please see Section 2.7 for more info.

Physical Keys

Even though you have your fingerprints registered and eKey stored, it's always best practice to keep your physical keys on a secure location or carry your existing deadbolts keys at all times in case for any reason.



To ensure you have access to newly added and latest features, please visit : www.Lockly.com/newfeatures

7.1 Cleaning

Keeping your Lockly clean insurers optimal performance. Follow the recommendations below.

DO

- Use a microfiber cloth to clean the fingerprint reader.
- Clean with slightly damp microfiber cloth to avoid scratches.
- When wet, allow to air dry or wipe dry with a soft microfiber cloth to avoid scratches.

DON'T

- Don't use abrasives, high Alkaline cleaners, or solvents to clean your lock.
- Don't apply cleaners in directly sunlight or during high temperatures.
- Don't leave cleaningde tergent on the lock for extended periods of time. Make sure to wash off immediately.
- Don't use scrapers,squeegees, or razors.

8.1 Safety Precautions

Read and remind all users of the following safety precautions

Lockly Smart Locks do not have any user serviceable internal parts. Do not attempt to disassemble the lock. It may cause product damage and/or personal injury and will void any warranty.

Do not use any inappropriate tools that might cause damage or malfunction to your lock.

Always check and make sure your door is securely closed and locked when you leave to prevent unwanted entry.

Restrict access to the back battery panel and check your app settings regularly to ensure registered access and fingerprints profiles have not been altered or deleted without your knowledge.

Always dispose of used batteries according to your local requirements.
NEVER BURN OR PUT BATTERIES IN AN INCINERATOR.



Unauthorized changes or modifications may void your product warranty. For technical assistance or issues using your Lockly Flex Touch, contact our customer care team at help@Lockly.com or visit Lockly.com/help.

FCC Warning:

This device complies with Part 15 of the FCC Rules. Operation is subject to the following two conditions: (1) This device may not cause harmful interference, and (2) this device must accept any interference received, including interference that may cause undesired operation.

NOTE 1: This equipment has been tested and found to comply with the limits for a Class B digital device, pursuant to part 15 of the FCC Rules. These limits are designed to provide reasonable protection against harmful interference in a residential installation. This equipment generates, uses and can radiate radio frequency energy and, if not installed and used in accordance with the instructions, may cause harmful interference to radio communications. However, there is no guarantee that interference will not occur in a particular installation. If this equipment does cause harmful interference to radio or television reception, which can be determined by turning the equipment off and on, the user is encouraged to try to correct the interference by one or more of the following measures:

- Reorient or relocate the receiving antenna.
- Increase the separation between the equipment and receiver.
- Connect the equipment into an outlet on a circuit different from that to which the receiver is connected.
- Consult the dealer or an experienced radio/TV technician for help.

NOTE 2: Any changes or modifications to this unit not expressly approved by the party responsible for compliance could void the user's authority to operate the equipment.

FCC Radiation Exposure Statement

This equipment complies with FCC radiation exposure limits set forth for an uncontrolled environment. It should be installed and operated with minimum distance 20cm between the radiator & your body.

IC WARNING

This device contains license-exempt transmitter(s) that comply with Innovation, Science and Economic Development Canada's licence-exempt RSS(s). Operation is subject to the following two conditions:

- (1) This device may not cause interference.
- (2) This device must accept any interference, including interference that may cause undesired operation of the device.

L'émetteur/récepteur exempt de licence contenu dans le présent appareil est conforme aux CNR d'Innovation, Sciences et Développement économique Canada applicables aux appareils radio exempts de licence. L'exploitation est autorisée aux deux conditions suivantes:

1. L'appareil ne doit pas produire de brouillage;
2. L'appareil doit accepter tout brouillage radioélectrique subi, même si le brouillage est susceptible d'en compromettre le fonctionnement.

IC Radiation Exposure Statement

This equipment meets the exemption from the routine evaluation limits in section 2.5 of RSS-102. It should be installed and operated with a minimum distance of 20cm between the radiator and any part of your body.

Cet équipement est conforme à l'exemption des limites d'évaluation habituelle de la section 2.5 de la norme RSS-102. Il doit être installé et utilisé à une distance minimale de 20 cm entre le radiateur et toute partie de votre corps.



WARNING: This product can expose you to chemicals including Lead, which is known to the State of California to cause cancer. For more information go to www.P65Warnings.ca.gov.

To ensure you have access to the most updated and newly added features of your Lockly smart lock, please visit: **www.Lockly.com/newfeatures**

For digital versions and instructional videos, please visit the following link:

<http://Lockly.com/help>

LOCKLY Enjoy the freedom™

FLEX TOUCH

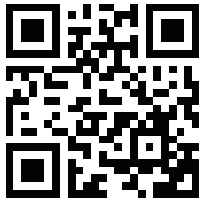

We're here to help!
help@Lockly.com
Lockly.com/help

© Copyright 2022 Lockly All rights reserved

USA Patent NO. US 9,881,146 B2 | USA Patent NO. US 9,853,815 B2 |
USA Patent NO. US 9,875,350 B2 | USA Patent NO. US 9,665,706 B2 |
USA Patent NO. US 11,010,463 B2 | AU Patent NO. 2013403169 | AU
Patent NO. 2014391959 | AU Patent NO. 2016412123 | AU Patent
NO. 202114328 | UK Patent NO. EP3059689B1 | UK Patent NO.
EP3176722B1 | USA Patent Application NO. 29/801,330

The Bluetooth® word mark and logos are registered trademarks owned by the Bluetooth SIG, Inc. , and any use of such marks by Lockly is under license. Other trademarks and trade names are those of their respective owners. Google, Android, Google Play and Google Home are trademarks of Google LLC. ,Amazon, Alexa and all related logos are trademarks of Amazon.com, Inc., or its affiliates.