

DEADBOLT EDITION



**LOCKLY<sup>®</sup> MODEL 7S**

**USER MANUAL**

# Table of Contents

## Section 1 - Product Highlights

1.1	Product Features	1
-----	------------------	---

## Section 2 - Product Overview

2.1	Product Overview - Outside	2
2.2	Product Overview - Inside	3
2.3	Understanding Your New Lock	4
2.4	Reset Button	5
2.5	Rebooting Your Lock	5
2.6	Low Battery	6
2.7	Changing The Battery	7

## Section 3 - Using Your Smart Lock

3.1	Configuring Access	9
3.2	Entering Programming Mode	10
3.3	Adding an Access Code	11
3.4	Deleting an Access Code	13
3.5	Checking an Access Code	15
3.6	Adding Secure Link Wi-Fi Hub	16

## Section 4 - Locking and Unlocking

4.1	Locking / Unlocking using Access Codes	17
4.2	Locking / Unlocking using App	18
4.3	Locking / Unlocking using Physical Key	19
4.4	Locking and Unlocking with Voice Assistant Control	20
4.5	Safe Mode	21

## Section 5 - Advanced Features

5.1	Offline Access Code™ (OAC)	23
5.2	SubAdmin	24

## Section 6 - Re-keying

6.1	Re-keying	25
-----	-----------	----

## Section 7 - Important Notes

7.1	Important Notes	26
-----	-----------------	----

## Section 8 - Cleaning

8.1	Cleaning	27
-----	----------	----

## Section 9 - Safety Precautions

9.1	Safety Precautions	28
-----	--------------------	----

For additional support, visit <http://lockly.com/help>  
or email [help@Lockly.com](mailto:help@Lockly.com)



# 1.1 Product Features

## **Patented Anti-Peep PIN Genie® Keypad**

Digits are randomly displayed on the keypad ensuring access codes to be undetectable to intruders after repeated use. Numbers are randomly distributed across 4 buttons, with 3 numbers in each button. Users can press any button showing their number. Location of the numbers are always different every time someone uses the keypad, making it hard for prying eyes to guess the correct code.

## **Multiple Access Codes & Monitoring**

Store up to 18 Access Codes for family, friends and guests, as well as monitor entry and exit records.

## **Live Monitoring and Voice Control**(Requires Secure Link Wi-fi Hub, sold separately)

Through your smartphone, monitor door access from anywhere in the world and securely control who comes and goes. You can also control your Lockly® smart lock using your voice with Amazon Alexa or Google Assistant.

## **Complete Privacy**

The exterior displayed keypad can be locked and switched off through the Lockly® App. The owner can prevent others trying to input the passcode from the outside and entering the home

## **Offline Access Code™ (OAC)**

The Offline Access Code™ can allow owners to issue access codes, set the allowed access duration, all without Lockly® ever connecting to the internet, so in case of power outage, you can still magically and remotely issue Access Codes without any connection to the web.

## **Auto-Lock**

Users no longer have to worry about forgetting to lock the door. With Auto Lock enabled, Lockly® will automatically auto-lock the door based on your customized time setting.

## **Backup Keys and 9V Battery Socket**

The door can be opened with physical backup keys. There is also a 9V battery connection socket for emergency power backup to access the keypad in case your smart lock runs out of battery.

## 2.1 Product Overview - Outside

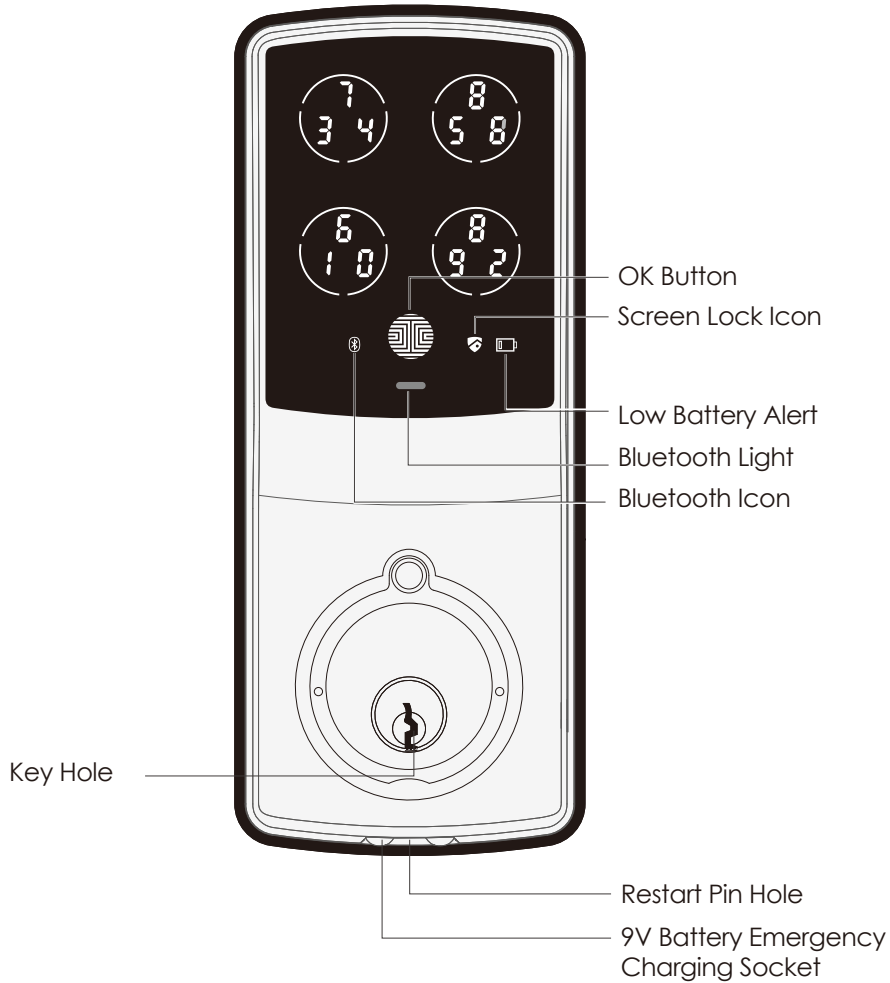

# 2.2 Product Overview - Inside

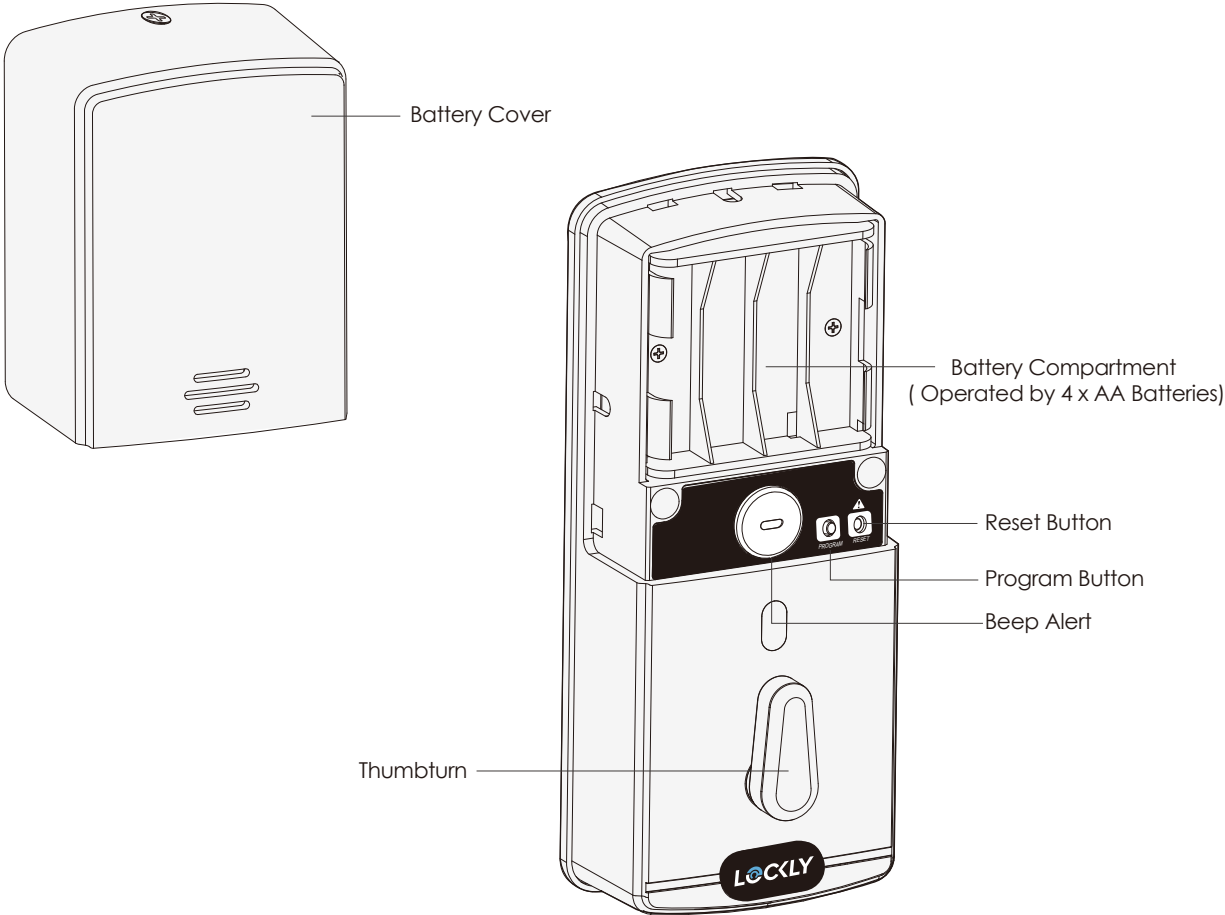

## 2.3 Understanding Your New Lock

After the installation of your new Lockly®, understanding some key functions of operating your smart lock is important. The following guides will walk you through resetting a lock, adding **Access Codes**, deleting **Access Codes**, and also how to configure your **OAC (Offline Access Code™)**.

For any questions you can always visit <http://lockly.com/help> for assistance.

Don't forget that Lockly® Secure works best with our iOS and Android app. Please download the app by visiting the link below.



Scan or visit [Lockly.com/app](http://Lockly.com/app)

## 2.4 Reset Button

In order to setup the Lockly® to another smart phone, you must have your “Activation Code” available. The Activation Code can be found on the Activation Code Card (PART U) that came with your smart lock.

After you have the **Activation Code** ready, push the **reset button** on the back panel of the Lockly® Secure to perform your reset. See below to see which **Reset Process** applies for you. Once the smart lock has been reset, all the data previously stored will be deleted.

Press **Reset Button** for **one (1) second** or till you hear a short beep

Open the Lockly® **smartphone app** to add your lock using the **Activation Code**

**If Never Paired**

Press **Reset Button** for **three (3) seconds**

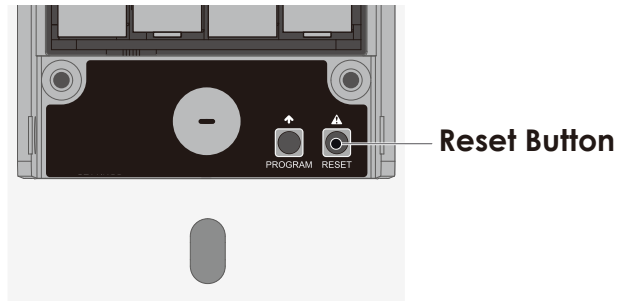

## 2.6 Rebooting Your Lock



### NOTICE

Reboot Lockly® in case of dead battery or malfunction. No settings will be changed and all Access Codes will still be stored within Lockly®.

Press and release the reboot button when you want to reboot the lock. Your Lockly® will beep once after reboot. Only reboot when necessary.

To reboot, find the reboot button located on the bottom of the exterior side of Lockly® lock. The reboot button is located in the middle of the two 9V battery backup sockets.

You will need something small such as a paperclip, to press the reboot button. Insert the paper clip and press down firmly and let go. Your screen should restart and the lock should reboot automatically.

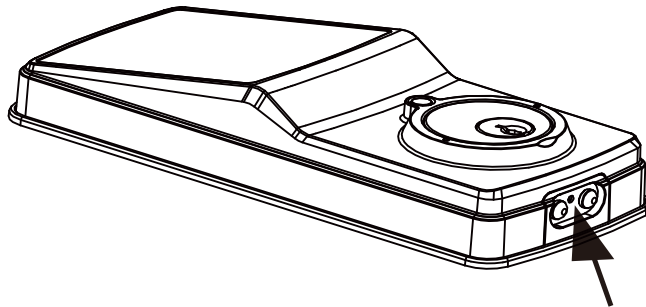

Reboot Button



## 2.7 Low Battery

When the battery is in seriously low condition, Lockly® will make continuous beeping sounds in addition to the flashing low battery icon on the touch screen. You should replace batteries **immediately** to avoid your smart lock from **shutting down**.

When your smart lock low-battery warning alert finally dies, you will have 3 chances to unlock your smart lock either by a password, APP or fingerprint. If the unlock was successful, the low-battery warning alert will be on for 1 minute. After which, the smart lock will go to dead-battery mode and will lock auto lock in 5 seconds and the screen will display a low-battery icon.

Condition	Indicator	Solution
<b>Low Battery</b>	Battery Icon on the display keypad will light up to indicate low battery. 	Replace batteries immediately to avoid battery failure. Lockly® Secure can still operate up to 300 cycles in low battery condition.
<b>Dead Battery</b>	When there is no display and sounds; and screen is non-functional.	Replace batteries immediately. Supplied physical backup keys can be used to unlock the door. Alternatively, use a 9V battery as shown below to temporarily activate the lock.

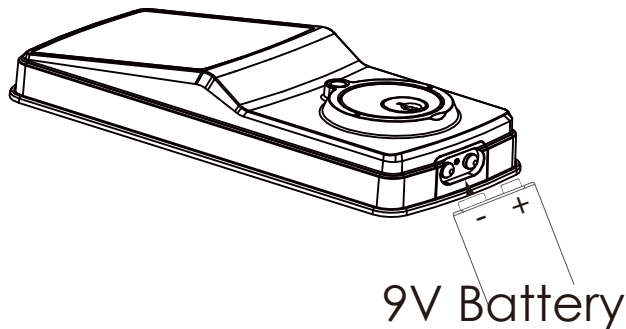

Your Lockly® will automatically detect battery polarity. So hold your 9V battery lead in place against bottom of the Lockly® to **temporarily** activate the screen to enter your **Access Code**. Be sure to hold the 9V battery against the contact points located at the bottom of the lock until you have successfully unlocked your door with your **Access Code**. Once unlocked, batteries should be replaced immediately.

## 2.8 Changing The Battery

Under normal use, the Lockly® battery will last up to a year. Please check battery levels **regularly** and change your batteries when the **low battery notification** is issued. For best practice, always use **new batteries** by a major brand.

Open the battery compartment cover and insert four (4) new AA alkaline batteries as shown. Be sure to unscrew the screw located on the top of the cover first by unscrewing counter clockwise before sliding the cover up.

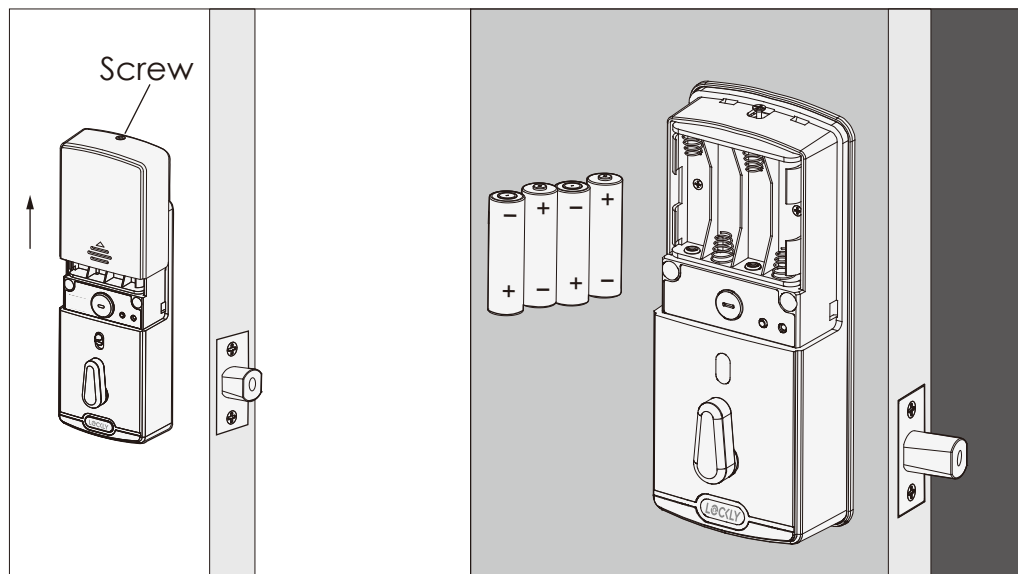

- Make sure the batteries are oriented correctly by matching the orientation displayed.
- Replacing the batteries do not reset stored **Access Codes**.
- To see a list of recommended brands, please visit <http://Lockly.com/battery>.



### NOTICE

Whenever batteries are replaced, reconnecting the smart lock to your smartphone App is required.  
If you have not yet downloaded the app, visit: [Lockly.com/app](http://Lockly.com/app)

## 3.1 Configuring Access



We recommend pairing your lock to your smart phone to manage your access codes. Section 3.1 - 3.9 refers to locks not paired with a smart phone. Once paired with a smart phone, the Program button will be disabled.

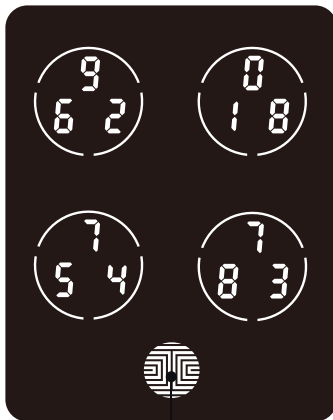

OK Button

There are a total of **five (5) buttons** on the keypad as shown in the example image to the left. The numbers in each button may differ than what is shown on your device than what is displayed here.

To enter your required digit, just simply press the circle where your number is shown. You do not need to press the actual number as anywhere within the circle will suffice.

The button on the bottom is the **OK** button. You will be pressing this button when you are done entering your **Access Code**.



**NOTICE**

The Default Access Code is

**1 2 3 4 5 6**

Your new Lockly® **Access Code** can be any combination of **6 to 8 digits**.

Once a new Access Code is entered, the **Default Access Code** of **123456** would be deleted. A maximum of 16 sets of Access Codes can be stored for use at any given time. To add more than 16 sets of Access Codes, you must delete an existing Access Code before adding a new code. If you're not using the APP, you can store up to 18 sets of **Access Code**.

## 3.2 Entering Programming Mode

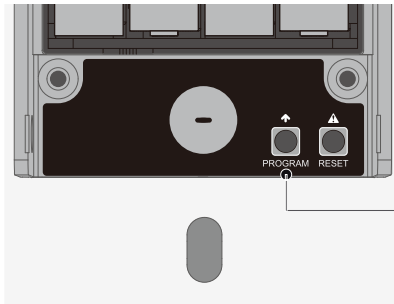

Program Button

To enter **Programming Mode**, remove the battery compartment cover on the interior side of the Secure to expose the **Reset** and **Program** buttons (See page 8).

Simply press the **Program** button to enter programming mode.

**Note:** **Program** button will be disabled once synced to a smart phone. Configure all settings via synced smart phone. Access Codes previously added by Programming mode will be cleared.

To end **Programming Mode**, press the **Program** button anytime.

**Programming Mode** will automatically exit if the keypad is inactive for more than thirty (30) seconds.

Number	Mode
1	AD Add Access Code
2	DE Delete Access Code
3	CH View Access Code

After entering **Programming Mode**, you should see the screen as displayed to the right on your Lockly® keypad. Follow the following steps to add, delete, or check your **Access Codes**.

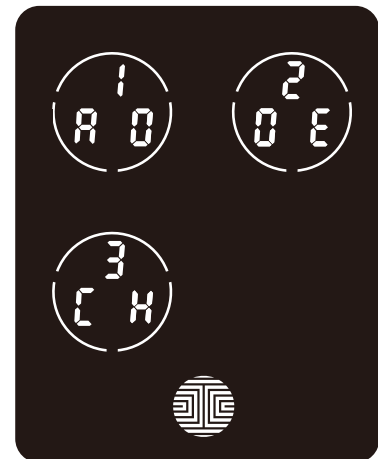

### 3.3 Adding an Access Code

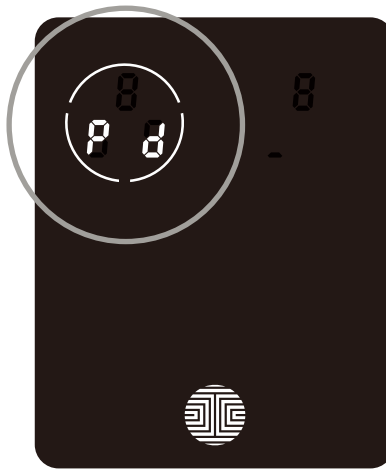
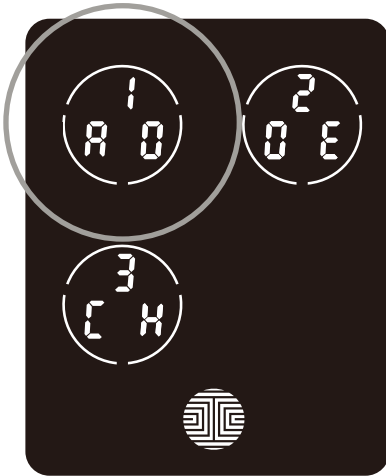

While in **Programming Mode**, select “1AD” to add an Access Code. If you are not in **Programming Mode**, please see **Section 3.2** to enter **Programming Mode**.

After pressing “1AD” to add an **Access Code**.

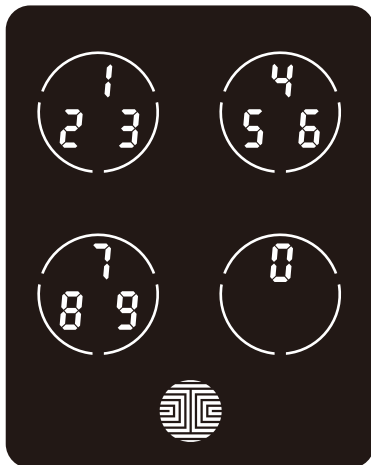

Enter your new **6 - 8 digit Access Code** and press  when you are finished. You will then re-enter the code to confirm your new **Access Code**.

Remember, just touch the digit you need within the circle around each 3 numbers. There is no need to touch the exact location of the number. For example, based on the example image to the left, if you need “1”, you can touch the **upper left** button. For “6”, you would touch the **upper right** button.

### 3.3 Adding an Access Code (Continued)

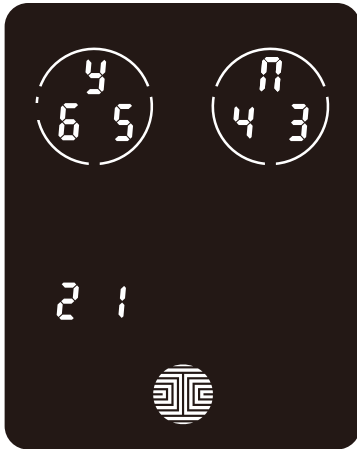

If you have successfully entered your new **Access Code** twice, you will see the new code displayed here. In this example, we chose **654321**. Press **7** to Confirm or **7** to cancel.

To exit or cancel, you can always press **7** or 

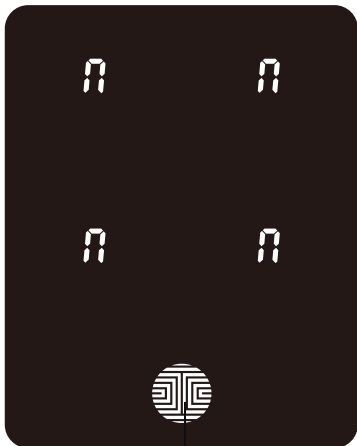

OK Button

If the two (2) **Access Codes** you entered does not match, an error message will appear on the screen (As shown to the left). Press **OK Button** to return to the **Programming Screen** and try again. See **Section 3.3**

## 3.4 Deleting an Access Code

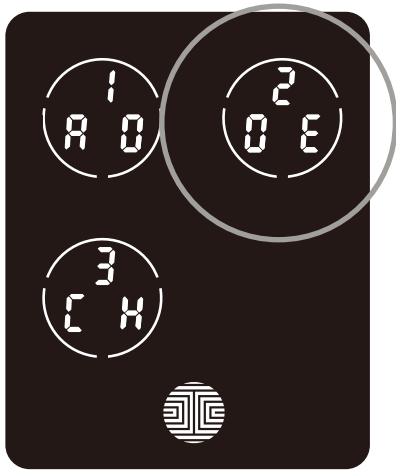

While in **Programming Mode**, select “2DE” to delete an **Access Code**. If you are not in **Programming Mode**, please see **Section 3.2** to enter **Programming Mode**.

After pressing “2DE” to delete an **Access Code**.

Example Only

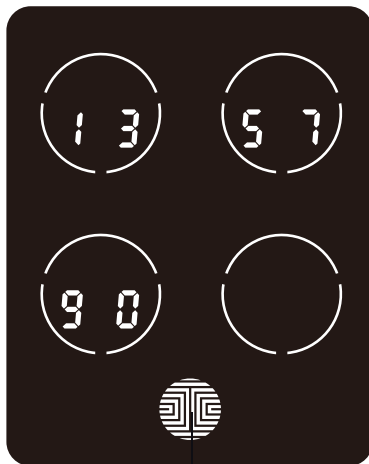

OK Button

Active **Access Codes** will then be displayed on the screen in sequence from **left to right, top to bottom**. In the example shown on the left, the **Access Code** displayed is **1 3 5 7 9 0**.

Rotate through different **Access Codes** shown by touching **any number** on the screen. If you find the **Access Code** you want to **delete**, simply **hold the OK Button for 3 seconds**. (Continue on next page)

## 3.4 Deleting an Access Code (Continued)

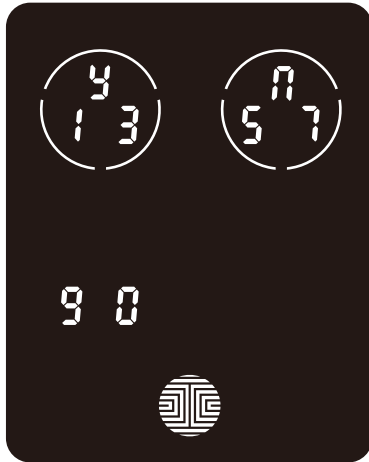

Once you have selected the **Access Code** you want to delete, Lockly® will ask you to confirm deletion by showing you the **Access Code** you are deleting, in this example, **1 3 5 7 9 0**.

Press **4** to **delete**, or **n** to **cancel**.

**NOTE** There are two incidents where your **Access Code** cannot be deleted.

There are no **Access Codes** set. The factory default Access Code cannot be deleted.

There is only one (1) **Access Code** saved in the smart lock. At least one code must be registered. Please add another **Access Code** before attempting to delete the existing code.

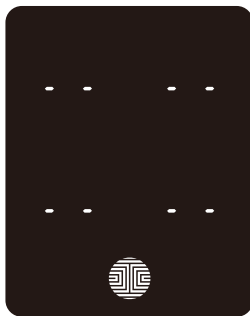

No Access Codes Set

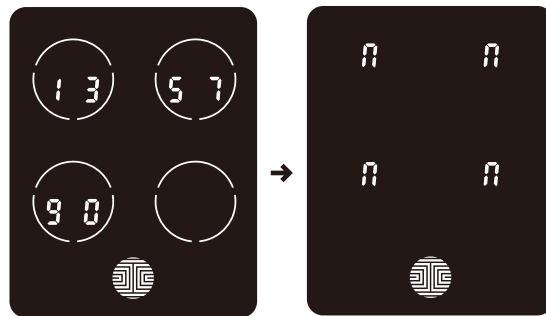

Only one Active Access Code



## 3.5 Checking the Access Codes

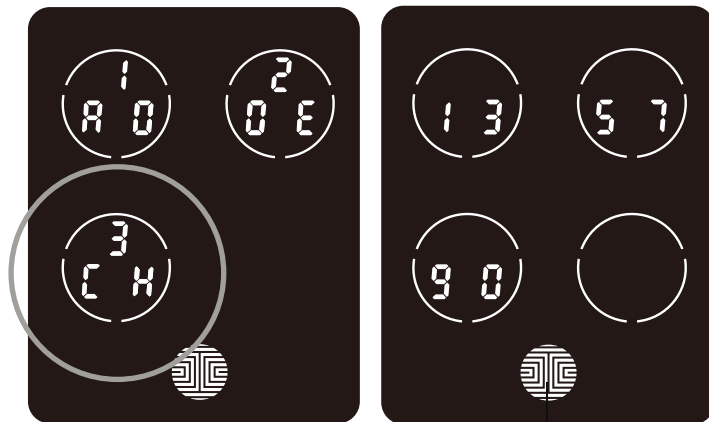

OK Button

While in **Programming Mode**, select “3CH” to check registered **Access Codes**. If you are not in **Programming Mode**, please see **Section 3.2** to enter **Programming Mode**.

Active **Access Codes** will then be displayed on the screen in sequence from **left to right, top to bottom**. In the example shown on the left, the Access Code displayed is **1 3 5 7 9 0**.

Rotate through the different **Access Codes** by touching any number on the screen. To exit **Check Access Code** screen, simply **press** the **OK Button**.

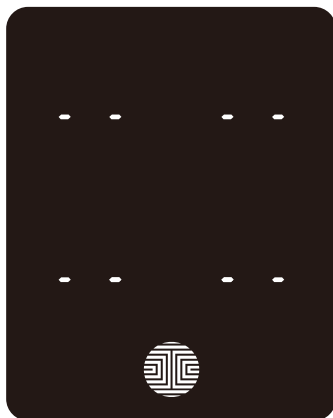

If there are no **Access Codes** registered in your smart lock, **Check Access Code** mode will be invalid. The default **Access Code** will not be shown on the display keypad, and you will see the following screen shown to the left instead.

## 3.6 Adding Secure Link

Lockly® Secure Link adds live status monitoring and voice control capabilities to your Lockly® Smart Lock. Secure Link can be purchased and added anytime.

To set up the Lockly® Model 7S smart lock with Secure Link Wi-Fi Hub and Door Sensors, launch the Lockly® App on your iOS or Android device. From the main menu drop down located on the upper left of the screen, select “Add a New Device” then select “Secure Link Wi-Fi Hub”. Follow the in-app instructions to set up your Secure Link.

To activate voice commands, you will need Amazon Alexa or Google Assistant. Make sure you enable the Lockly® Action for Google Assistant or the Amazon Alexa Skill before you can configure your voice to perform voice commands.

Visit the link below to purchase:

**<https://lockly.com/hub>**

## 4.1 Locking/Unlocking with Access Codes

Lockly® Smart Lock can be unlocked using multiple ways - via your stored **Access Code**, smartphone with **Bluetooth**, the **physical key** supplied with your lock, or voice (Secure Pro only or Secure Plus with Secure Link Wi-Fi Hub installed)

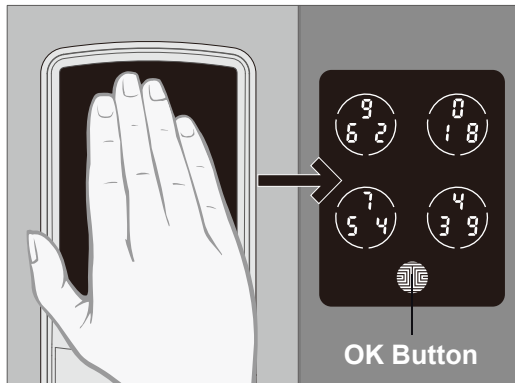

Slide your hand across the screen to activate the keypad.

Enter your **6 to 8 digit Access Code** followed by the **OK** button. Press **OK** anytime to reset if you entered the wrong digit.

If the **Access Code** entered is correct, the door will unlock. If the **Access Code** entered is incorrect, Lockly® will **flash red light**.



**Three consecutive wrong attempts will put Lockly® in "Safe Mode". (See Section 4.5)**

**Lock** your Lockly® by pressing the **OK Button** or by brushing your hand across the screen anytime when the door is closed. The smart lock will also auto-lock after unlocking based on your set auto-lock settings.

You may toggle between two types of keypad displays to enter your **Access Code**. The **fixed digit** version and the **PIN Genie®** version (Recommended). Press and hold the **OK Button** for 3 seconds to toggle back and forth between the two keypads. *(Sample display shown only)*

Hold OK Button (3 sec)

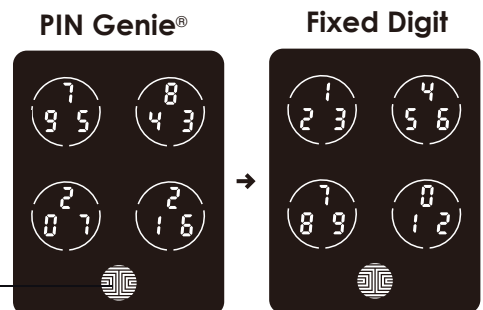

## 4.2 Locking/Unlocking Lockly® with App

You must have the Lockly® iOS or Android app installed in order to lock and unlock with smartphone and connect with voice assistants like Alexa or Google Assistant. Please download the app by visiting the link below or search “Lockly” from the correct app store.



**Scan or visit [Lockly.com/app](https://lockly.com/app)**

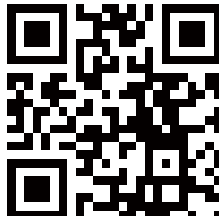

## 4.3 Locking/Unlocking with Physical Key

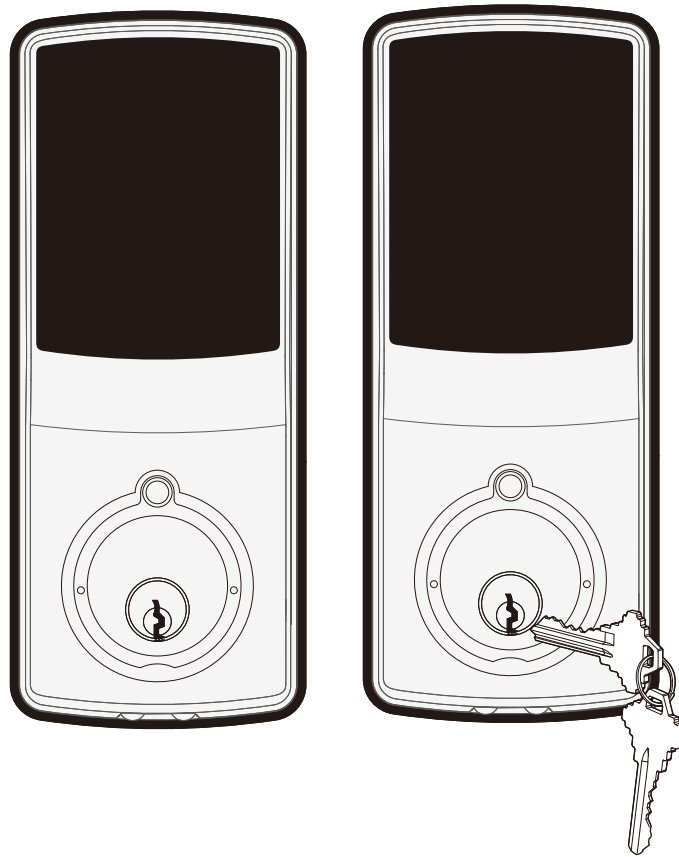

Exterior View

To unlock your lock using the physical key (included), insert your key and turn clockwise or counter clockwise to lock or unlock the door.

## 4.4 Locking and Unlocking with Voice Assistants

Once your Lockly® Model 7S and Secure Link Wi-Fi Hub has been installed and configured correctly, make sure you enable the Lockly® Action for Google Assistant or the Amazon Alexa Skill before you can configure your voice to perform voice commands.

You can ask your questions such as door status or request for your door to be locked or unlocked



- "Hey Google, unlock my Back Door"\*
- "Hey Google, is my Back Door locked?"
- "Hey Google, lock my Back Door"
- "Hey Google, is my Back Door unlocked?"





- Alexa, unlock my Front Door.\*
- Alexa, is my Front Door locked?
- Hi Alexa, lock my Front Door.
- Alexa, is my Front Door unlocked?

\*Unlock requests will require additional voice security codes.  
You may configure it in the settings page.

Google, Android and Google Play are trademarks of Google LLC.

## 4.5 Safe Mode - Overview

Lockly® will enter **Safe Mode** when three (3) consecutive wrong **Access Codes** are entered within 5 minutes. When in **Safe Mode**, the lock status icon  will start to flash.

To disable **Safe Mode**, you must unlock the door using the correct fingerprint or enter the correct **Access Code** twice in a row. Activate the keypad by pressing and holding  for 3 seconds.

Once the screen is activated, enter the correct **Access Code** carefully twice, pressing  after every time.

If you enter the wrong code, the keypad will then be disabled for **10 minutes**.

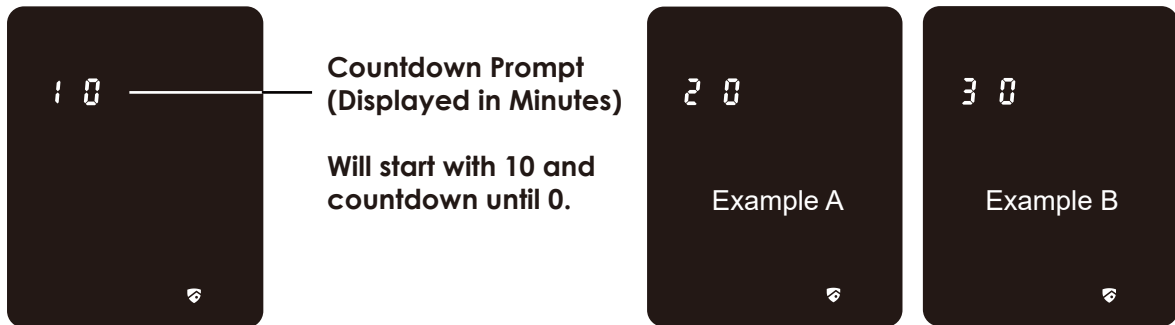



You will see a “10” on the screen, notifying the number of minutes that the keypad is disabled for. After **10 minutes**, you may attempt to enter the correct **Access Code** to unlock the door. After the second incorrect attempt to unlock the lock with the wrong **Access Code**, Lockly® will disable the keypad for **20 minutes**, displaying a “20” on the screen. After the third wrong attempt to unlock the door with the correct **Access Code**, the screen will be disabled for **30 minutes**. (Example A and Example B above).

**Note:** In order to conserve power, the countdown prompt will only be displayed for 3 seconds. You can reactivate the screen by sliding your hand across the screen.

## 4.5 Disabling Safe Mode

There are four (4) ways to disable **Safe Mode**.

### Option 1 - Entering Correct Access Code

Activate the keypad by pressing and holding  for 3 seconds. Enter the correct **Access Code** twice (2) when the keypad is available, pressing  after every time the **Access Code** is entered.

### Option 2 - Lockly® Bluetooth App

Use the app that is synced to your Lockly® to disable **Safe Mode** by unlocking the door. If you have not downloaded the app to use with your smart lock, you won't be able to use this option to disable **Safe Mode**.

### Option 3 - Physical Key

There is a pair of keys supplied with your new lock. You may use the keys to manually **unlock** the door and disable **Safe Mode**. To learn how to use your physical keys, see **Section 4.3**.



## 5.1 Offline Access Code™ (OAC)

The **Offline Access Code™ (OAC)** is a unique feature of our smart lock. It allows you to grant access to guests remotely without guests needing to download the app.

To use the **OAC** feature, make sure you download the Lockly® app for iOS or Android first, and sync your smart lock to your mobile device. OAC can only be issued by the administrative owner of the lock.

From there, you can then issue an **Offline Access Code™** within the app.

Go to “**Access**” and choose “**Add a New User, then select Offline Access Code™ (OAC)**” and follow on screen instructions to generate your **Offline Access Code™**.

### Understanding Offline Access Code™ (OAC)

**OAC** are issued to the guest by asking them to enter 4-12 digit number after a double - click on the . Your Lockly® randomly generates the **Offline Access Code™** which can be shared to your guests together with the instructions generated using the Lockly® app.

After a double-click on the , touchscreen will display numbers on **Fixed Digit** mode, then guest can enter the **Offline Access Code™**

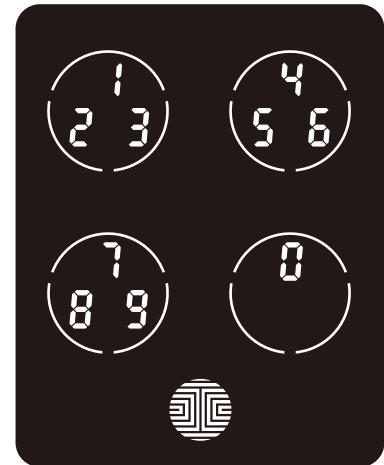

## 5.2 Sub-Admin Access

Sub-Admin Access can be created to grant access for others to be able to control your lock and grant access to others via Bluetooth when within range of your Lockly® smart lock. The sub-admin permission can be setup through the Lockly® App then Add A New User.

You can select the Validity Period and User Permissions of the sub-admin.

Sub Admins will not be able to access the lock remotely but Sub Admin will be able to grant limited access codes to users when within Bluetooth range. Once Sub Admin control is setup, you as the Admin will no longer be able to issue Offline Access Code™ (OAC)

The Sub-Admin access is ideal for long term property leasing and Airbnb tenants. can enter the **Offline Access Code™**

## 6.1 Re-keying

Lockly® smart lock comes with a 6-pin cylinder which can be replaced with regularly purchased DIY re-keying kit available in the market.

If you are not familiar with this process, please contact a professional locksmith. For more information, visit : <http://support.lockly.com/faq/rekeying/>

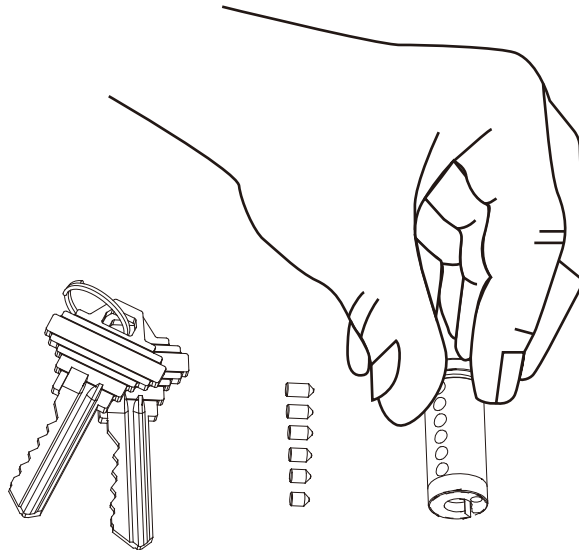

# 7.1 Important Notes

## Auto Lock Feature

Your lock can be programmed to auto-lock between 5-300 seconds after the door opening. You can select the timing through the Lockly® App. If auto-lock is not activated and door is still open, the touchscreen will remain lighted, simply press the  on the keypad to lock.

## One-Touch Locking

You can always manually do a quick lock by touching anywhere on the touchscreen. Lockly® smart lock is shipped with this feature already activated. You may deactivate this feature through the Lockly® App.

## 9V Backup Access

When your **Lockly®** is out of power, you can temporarily activate the keypad by using a 9V battery against the bottom of the exterior side of the smart lock. Please see **Section 2.6** for more info.

## Physical Keys

Even though you have your **fingerprints** registered and **Access Codes** stored, it's always best practice to carry your physical keys with you at all times in case for any reason your lock falls into **Safe Mode**.

## Activation Code

You may find an **Activation Card** with an **Activation Code** included in your package. It is very crucial that you do not lose this card. Please store this card safely as you will need the default **Activation Code** on that card to **master reset** your lock in case, for any reason, you have lost the phone paired to Lockly® and also forgot your **Access Code**.

## Troubleshooting

Please visit <http://lockly.com/help> for troubleshooting and the most frequently asked questions and answers.

## 8.1 Cleaning

Making sure your Lockly® is clean is best practice to ensure optimal product use. Follow the DOs and DON'Ts below.

### DO

- Rinse the touchscreen with warm water prior to cleaning.
- Use the application of soap with a damp, lukewarm cloth.
- Air dry or wipe dry with a soft microfiber cloth to avoid scratches.

### DON'T

- Don't use abrasives, high alkaline cleaners, or gasoline to clean your lock.
- Don't apply cleaning detergent directly in sunlight or at high temperatures.
- Don't leave cleaning detergent on the display keypad for long periods of time - wash immediately.
- Don't use scrapers, squeegees, or razors.

## 9.1 Safety Precautions

Please read all instructions carefully. Remind all Lockly® users of the safety precautions.

### Read the following instructions for your own safety

Do not attempt to disassemble the smart lock by yourself. It can cause product damage, void warranty, and cause injuries.

Do not use any inappropriate tools that can cause damages or malfunction to your lock.

Always make sure your door is securely closed and locked when you leave your house to prevent unwanted entry.

Please keep your Access Codes safe. Restrict access to the back panel of your smart lock and check your settings regularly to ensure Access Codes have not been changed without your knowledge.

Always dispose of used batteries according to your local laws. **DO NOT BURN.**



Unauthorized changes and modifications may void your product warranty. If you have questions or any problems while using your Lockly® Smart Lock, contact our customer service department at [help@Lockly.com](mailto:help@Lockly.com) or visit <http://lockly.com/help> for technical assistance.



**Certified**

**FCC Warning:**

This device complies with Part 15 of the FCC Rules. Operation is subject to the following two conditions: (1) This device may not cause harmful interference, and (2) this device must accept any interference received, including interference that may cause undesired operation.

**NOTE 1:** This equipment has been tested and found to comply with the limits for a Class B digital device, pursuant to part 15 of the FCC Rules. These limits are designed to provide reasonable protection against harmful interference in a residential installation. This equipment generates, uses and can radiate radio frequency energy and, if not installed and used in accordance with the instructions, may cause harmful interference to radio communications. However, there is no guarantee that interference will not occur in a particular installation. If this equipment does cause harmful interference to radio or television reception, which can be determined by turning the equipment off and on, the user is encouraged to try to correct the interference by one or more of the following measures:

- Reorient or relocate the receiving antenna.
- Increase the separation between the equipment and receiver.
- Connect the equipment into an outlet on a circuit different from that to which the receiver is connected.
- Consult the dealer or an experienced radio/TV technician for help.

**NOTE 2:** Any changes or modifications to this unit not expressly approved by the party responsible for compliance could void the user's authority to operate the equipment.

**FCC Radiation Exposure Statement**

The Secure Link Wi-Fi Hub complies with FCC radiation exposure limits set forth for an uncontrolled environment. It should be installed and operated with minimum distance 20cm between the radiator & your body.

**IC WARNING**

This device contains licence-exempt transmitter(s) that comply with Innovation, Science and Economic Development Canada's licence-exempt RSS(s).

Operation is subject to the following two conditions:

- (1) This device may not cause interference.
- (2) This device must accept any interference, including interference that may cause undesired operation of the device.

L'émetteur/récepteur exempt de licence contenu dans le présent appareil est conforme aux CNR d'Innovation, Sciences et Développement économique Canada applicables aux appareils radio exempts de licence. L'exploitation est autorisée aux deux conditions suivantes:

1. L'appareil ne doit pas produire de brouillage;
2. L'appareil doit accepter tout brouillage radioélectrique subi, même si le brouillage est susceptible d'en compromettre le fonctionnement.

### **IC Radiation Exposure Statement**

This equipment meets the exemption from the routine evaluation limits in section 2.5 of RSS-102. It should be installed and operated with a minimum distance of 20cm between the radiator and any part of your body.

Cet équipement est conforme à l'exemption des limites d'évaluation habituelle de la section 2.5 de l'norme RSS-102. Il doit être installé et utilisé à une distance minimale de 20 cm entre le radiateur et toute partie de votre corps.

 **WARNING:** This product can expose you to chemicals including Lead, which is known to the State of California to cause cancer. For more information go to [www.P65Warnings.ca.gov](http://www.P65Warnings.ca.gov).



# LOCKLY<sup>®</sup> MODEL 7S



We're here to help!  
[help@lockly.com](mailto:help@lockly.com)  
<https://lockly.com/help>

**USA 9 665706 | CHINA 201310487970 | HONG KONG 1194496 |  
EUROPE 3059689 | AUSTRALIA 2013403169 | RUSSIA 2665222 |  
TAIWAN 621028 | KOREA 101860096 | INDONESIA 0020160364 |  
Other Patents Pending**

**LOCKLY® All Rights Reserved**

**Lockly® Smart Lock - Secure**

**Lockly® Smart Lock - Secure Plus**

**Lockly® Smart Lock - Secure Pro**

**Lockly® Smart Lock - Secure Lux**

**Lockly® Model 6S**

**Lockly® Model 7S**

About Lockly® Secure, Secure Plus, Secure Pro and Secure Lux are keyless smart locks equipped with the patented PIN Genie®, which is a peep proof and hidden camera proof algorithm software. Lockly® makes your life easier and safer.

For the latest version of this manual, please visit the link below:

<http://lockly.com/help>