

PURPLE LEAF

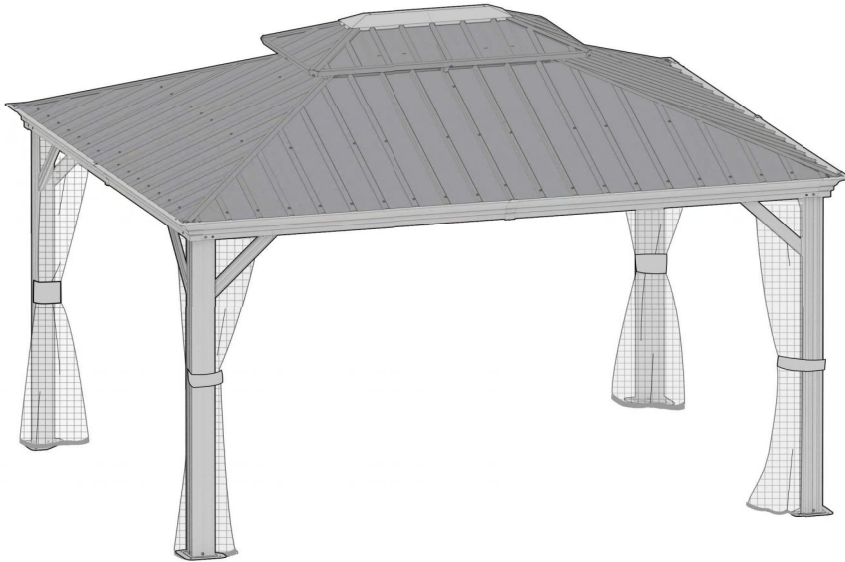

10' x 14'

**TEAK HARDTOP GAZEBO
WITH DOUBLE ROOF**

Assembly Manual

Thank you for your purchase of

PURPLE LEAF's Gazebo

Read and follow this assembly and operation guide.

To reduce personal injury and damage to your gazebo

Please **tighten the curtains and netting to the pole** when it is incoming over
30 mph wind.

We recommend a **two-person team** for assembly and disassembly.

If you are satisfied with our product, share with your friends.

If you have any problems with our product, feel free to contact us.

PURPLE LEAF



Warnings and Cautions

Please read the instruction carefully before assembly and retain it for future usage.

Make sure you have all the parts & hardware as the check list shows.

2 adults or more are recommended to install your gazebo.

Do not discard any of the packaging until you have checked that you have all the parts and pack of fittings.

Check all bolts for tightness before using, and periodically check and tighten bolts to ensure your gazebo works properly.

Some parts might have sharp edges/corners. Please follow basic safety precautions to reduce the risk of injuries.

Anchor the gazebo as soon as finish the installation.

CHOKER HAZARD

**THIS ITEM CONTAINS SMALL PARTS WHICH CAN BE SWALLOWED BY CHILDREN.
PLEASE KEEP IT AWAY FROM CHILDREN UNDER 3 YEARS OLD and PETS DURING
INSTALLATION.**

Pre-assembly

TOOLS THAT MAY BE REQUIRED (Not included in boxes)

*NOTE: Tools / equipment are not shown to actual size and scale.



LEVEL



RUBBER MALLET



CROSS SCREWDRIVER



DRILL



ALLEN KEY
(BIT 5/32")



ALLEN KEY
(BIT 7/32")

EQUIPMENT REQUIRED (Not included in boxes)

*NOTE: Equipment are not shown to actual size and scale.



SAFETY HAT



GLOVES



SAFETY GOGGLES



STEPLADDER

Matters needing attention



1. Two or more people are required for assembly.



2. Do not fully tighten the screws until finish each step of installation.

MOUNTING BLUEPRINT

Gazebo 10' x 14'

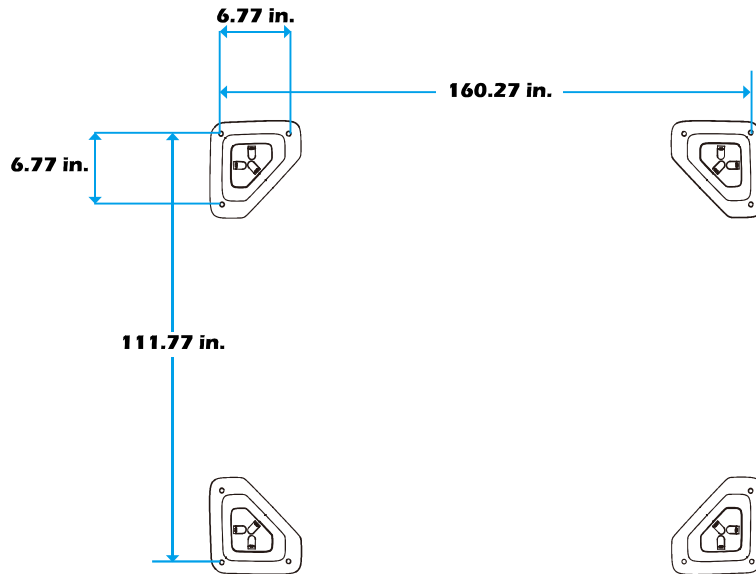

1

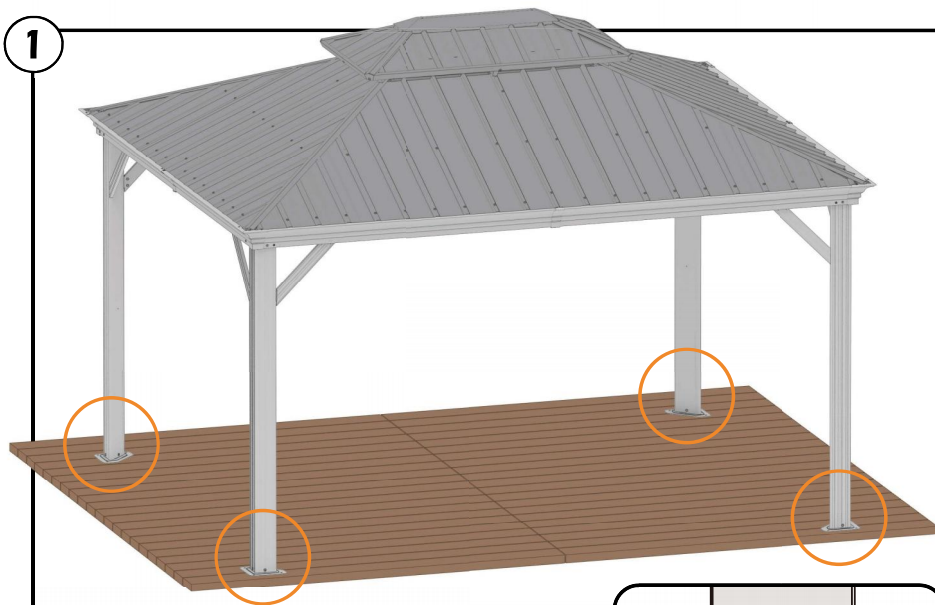

×12

If the deck is hardwood and the depth of it is over 3 inches, you can use **1/4 in. ×3 in. Structural Wood Screw** to mount the gazebo.

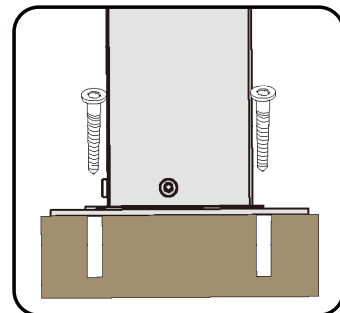
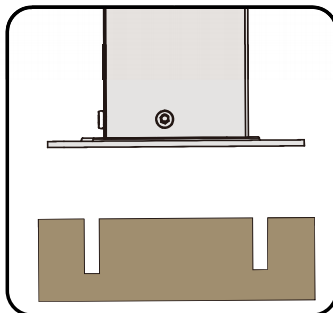

2

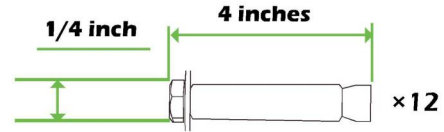
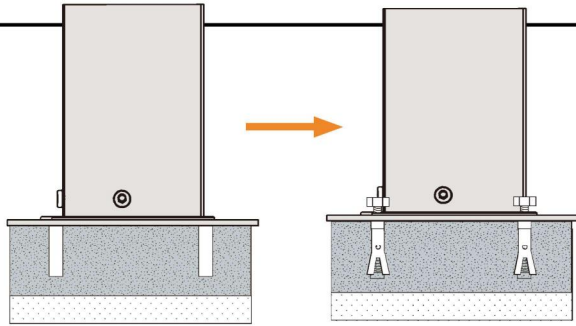

If the ground is concrete and the depth of it is over 3 inches, you can use 1/4 inch expansion bolts to mount the gazebo

3



Or you can make concrete footings for gazebo. **15×15×15 inches** is recommended. Using expansion bolts to mount the gazebo like ② shows.



IMPORTANT:
Anchor is not recommended



CHECK LIST



A × 4



B × 2

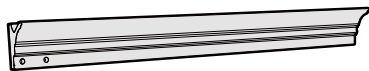

B1 × 2



B2 × 2



C × 2



C1 × 2



C2 × 2



D × 2

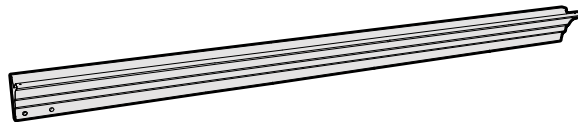

D1 × 2

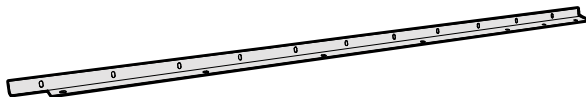

D2 × 2



E × 2

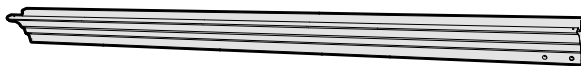

E1 × 2

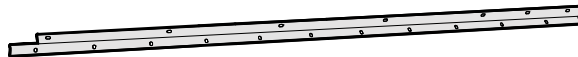

E2 × 2



F × 4

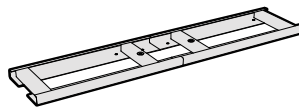

G × 4

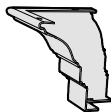

H × 4

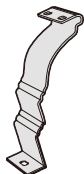

H1 × 4

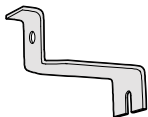

H2 × 1



J1 × 4



J2 × 4



K × 1

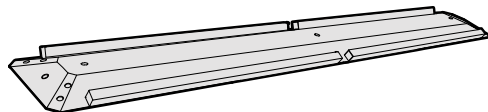

K1 × 1

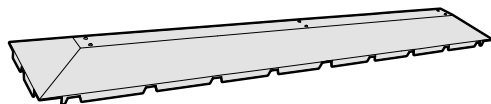

L × 4

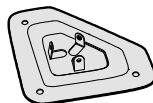

M × 4



N × 4



P × 2



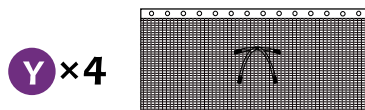
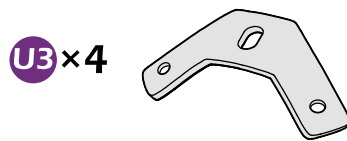
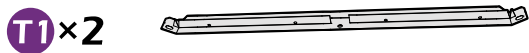
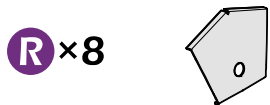
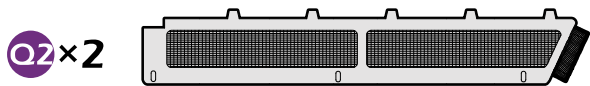
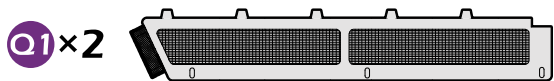
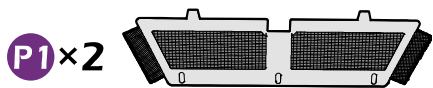

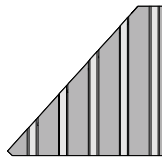

V1×2

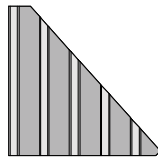

V2×2

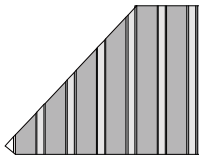

V3×2

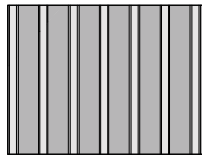

V4×4

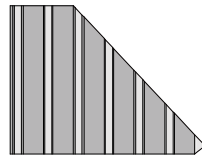

V5×2

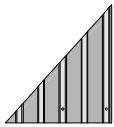

W1×2

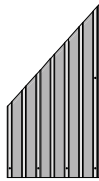

W2×2

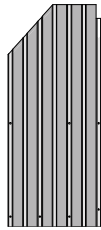

W3×2

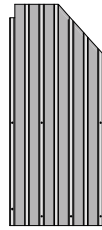

W4×2

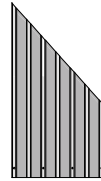

W5×2

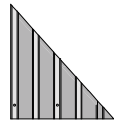

W6×2

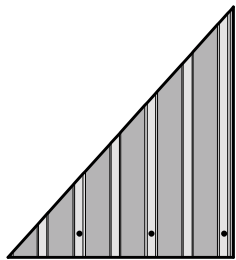

X1×2

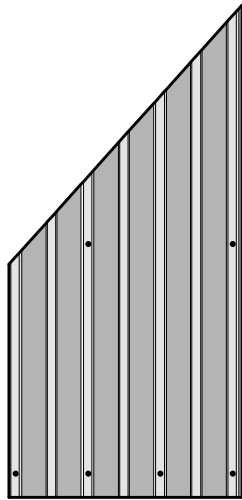

X2×2

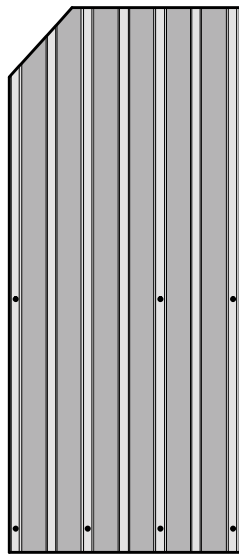

X3×2

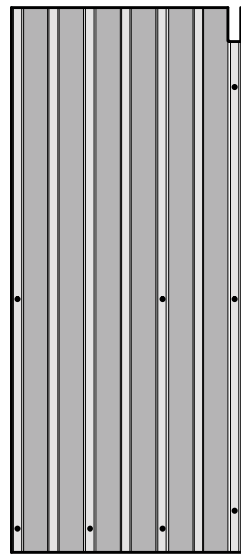

X4×2

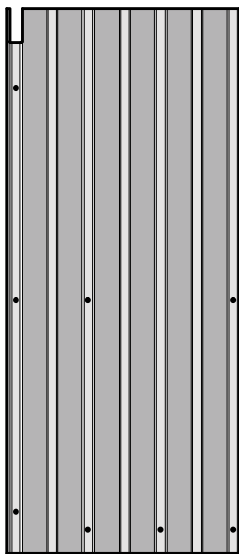

X5×2

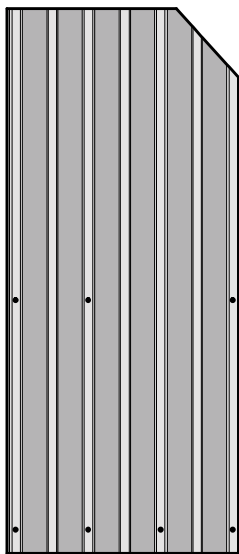

X6×2

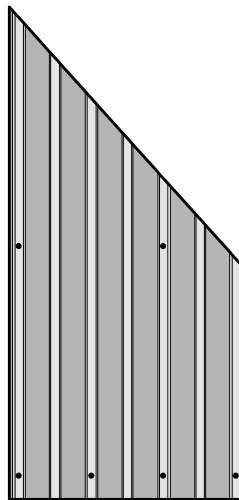

X7×2

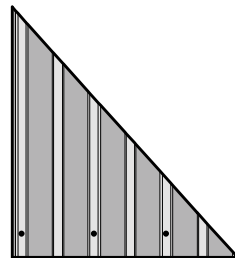

X8×2

Z×56



Z1×6



Z2×6



Z3×2



Z4×2



1#×215

(M6×16)



2#×16

(M6×20)



3#×16



4#×56

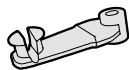

5#×72

(M6×28)



6#×8

(M6×45)

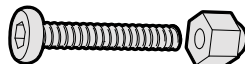

7#×32

(M6×50)

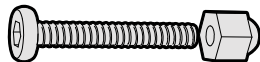

8#×4

(M5×16)

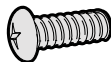

9#×24

(ST4.8×13)

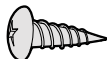

10#×4

(M6×25)

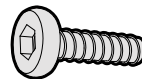

11#×12

(M6×10)

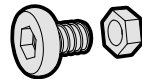

12#×1



13#×1



14#×1



15#×1



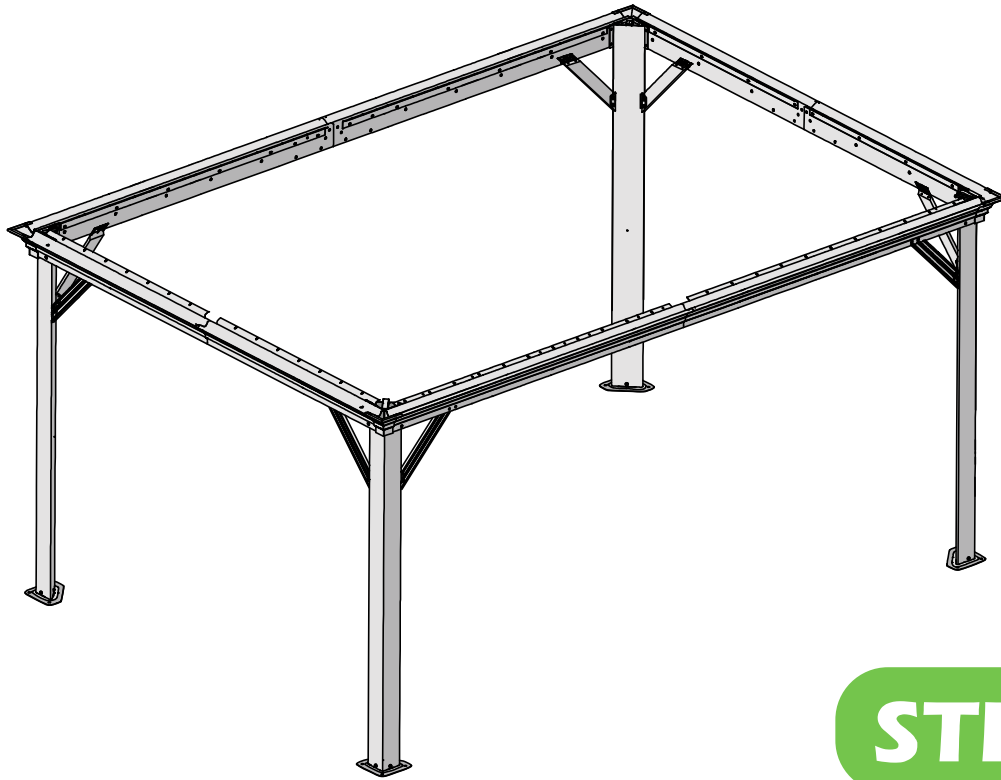

STEP 1



A × 4

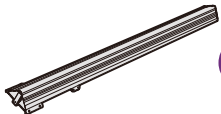

L × 4

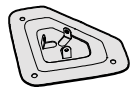

1# × 12

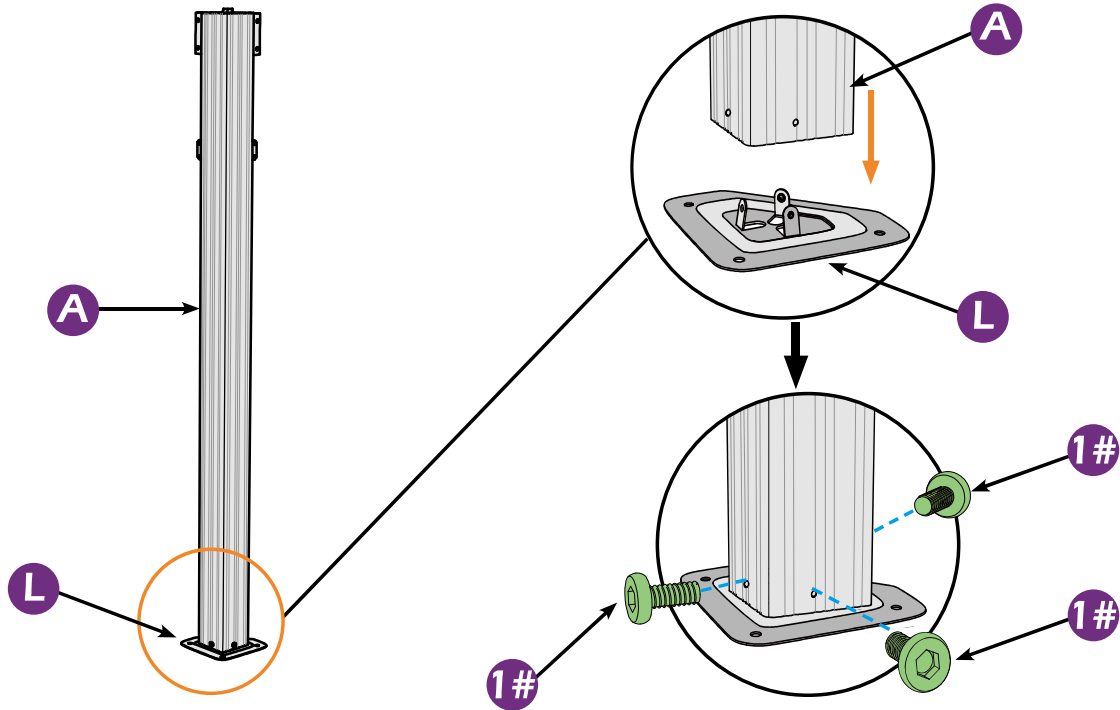

STEP 1



B × 2

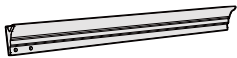

F × 2

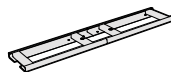

C × 2



1# × 8

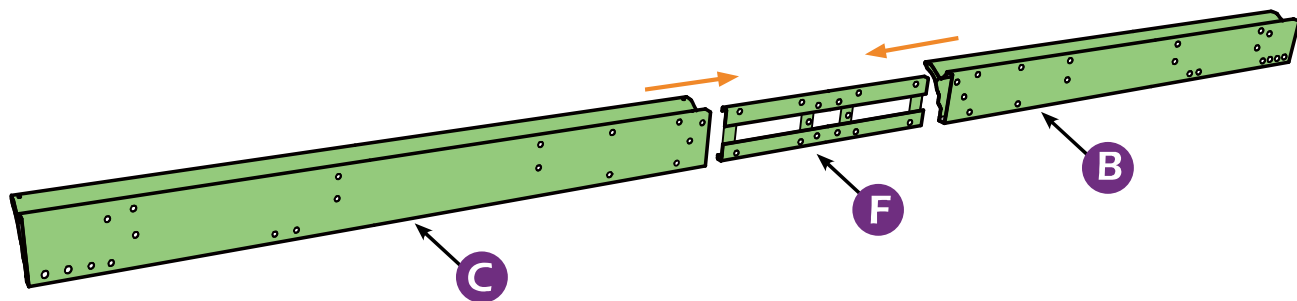

STEP 1

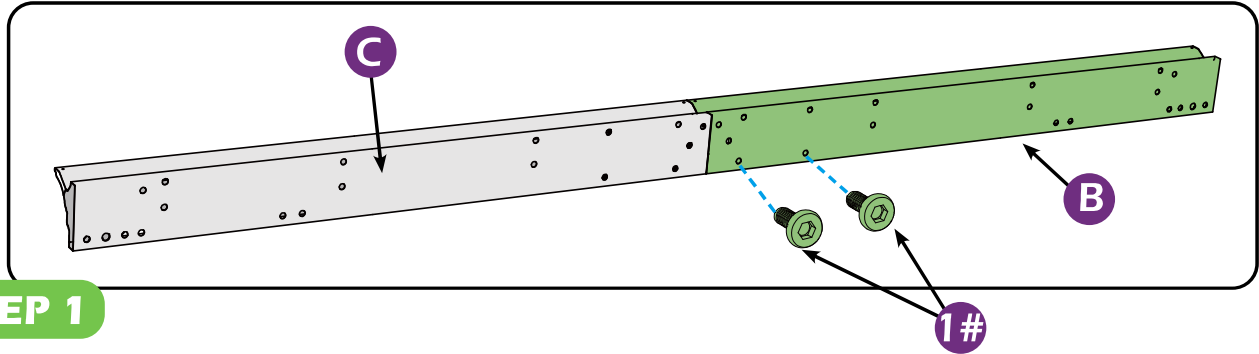
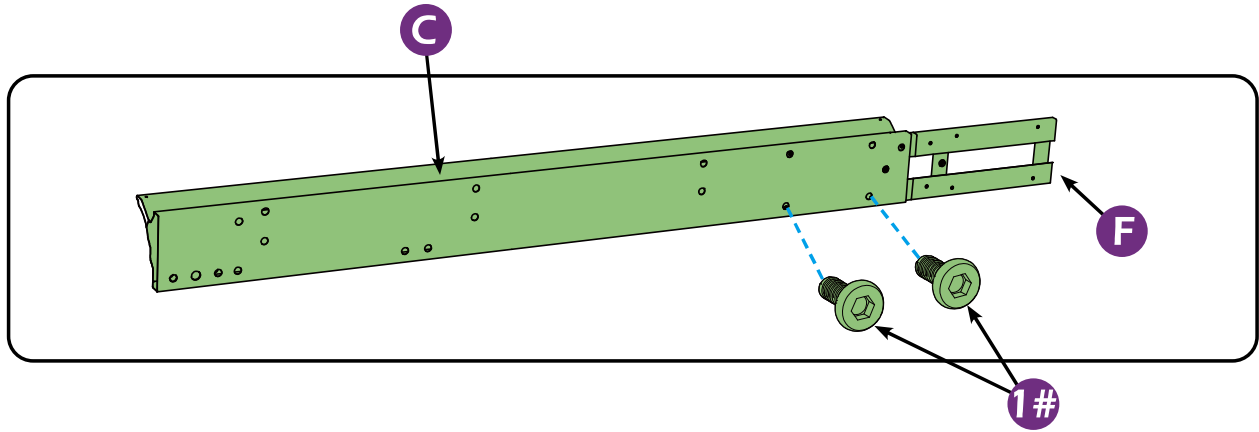

STEP 1



C1 × 2



1# × 20



B1 × 2

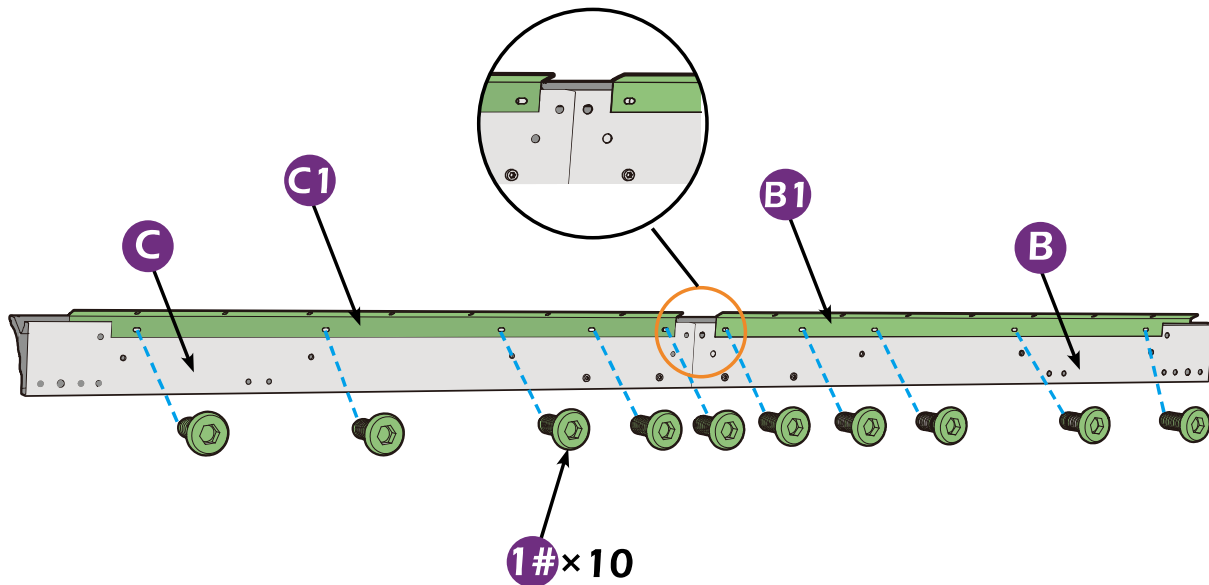

STEP 1



D × 2

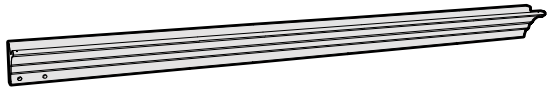

F × 2

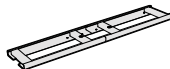

E × 2

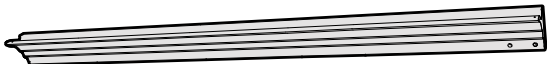

1# × 8

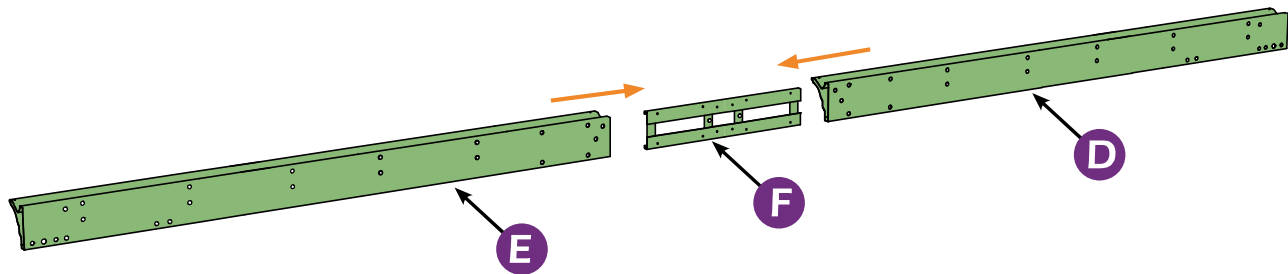

STEP 1

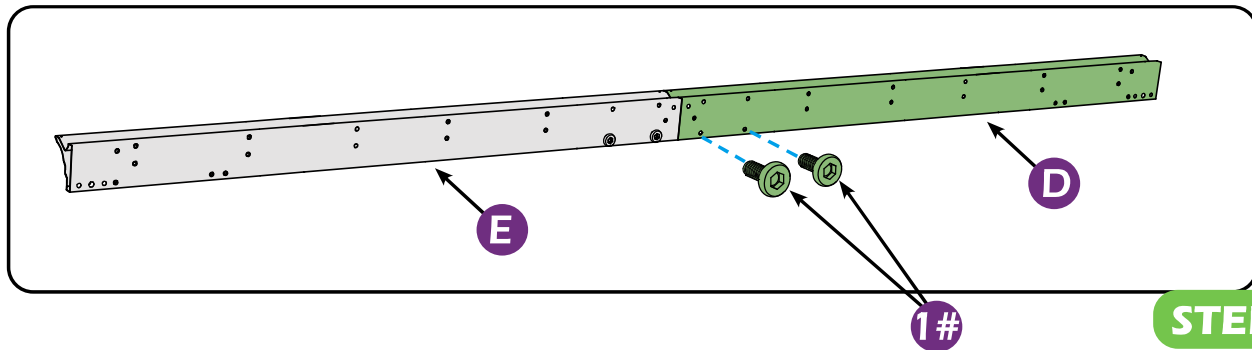
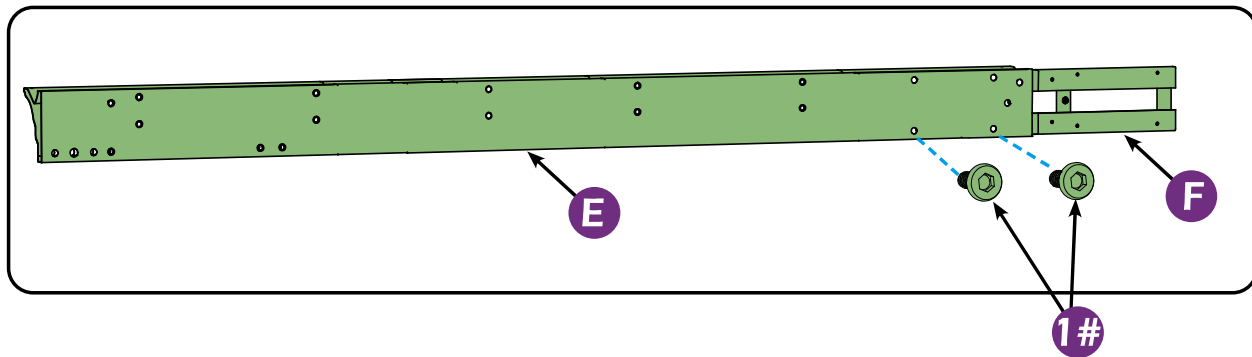

STEP 1



E1 × 2

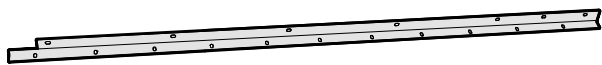

1# × 28



D1 × 2

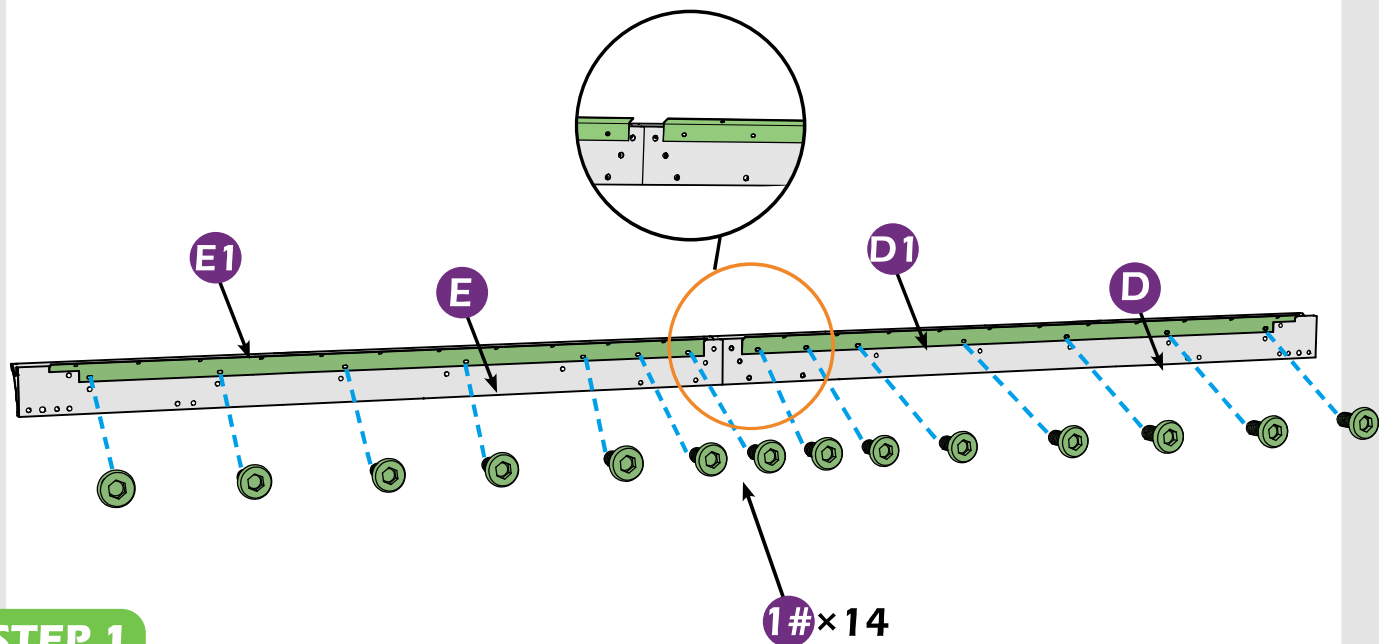
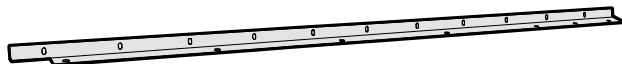

STEP 1



2# × 16



3# × 16

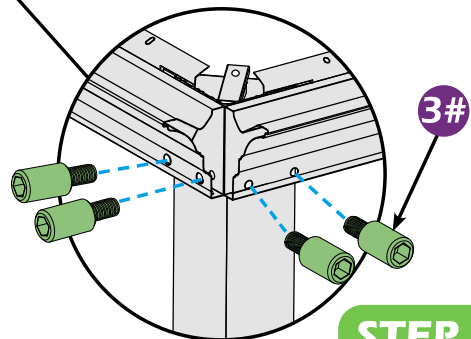
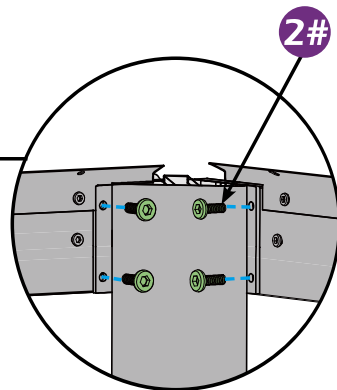
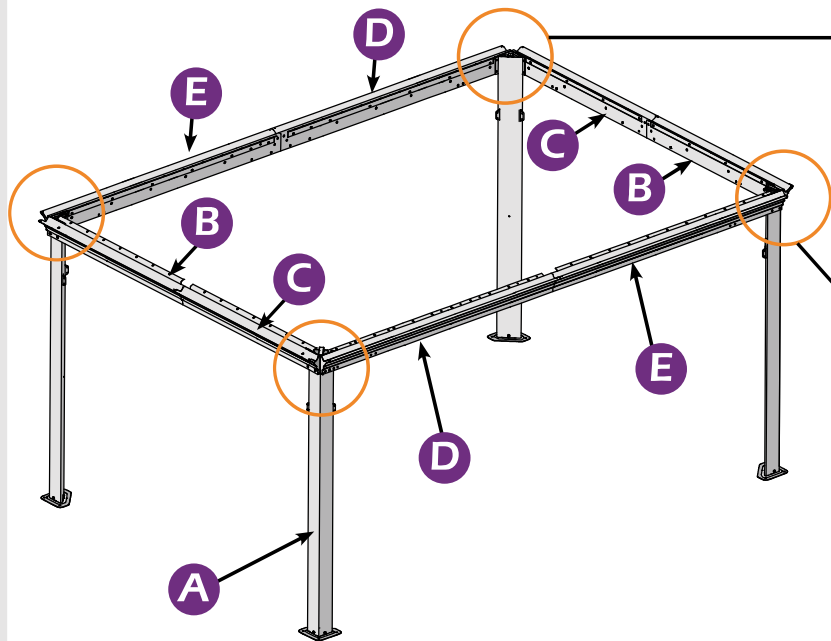

STEP 1



J1 × 4



1# × 32



J2 × 4

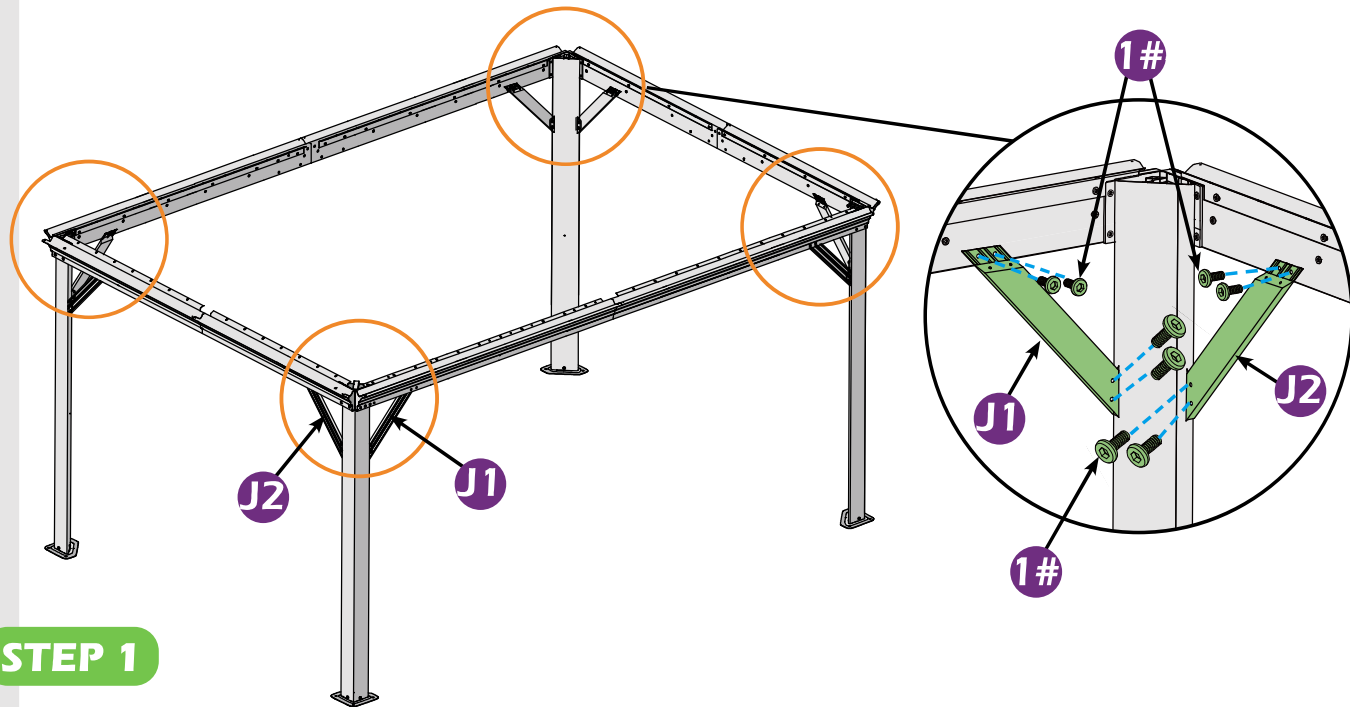

STEP 1



G × 4

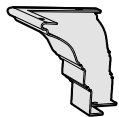

9# × 16

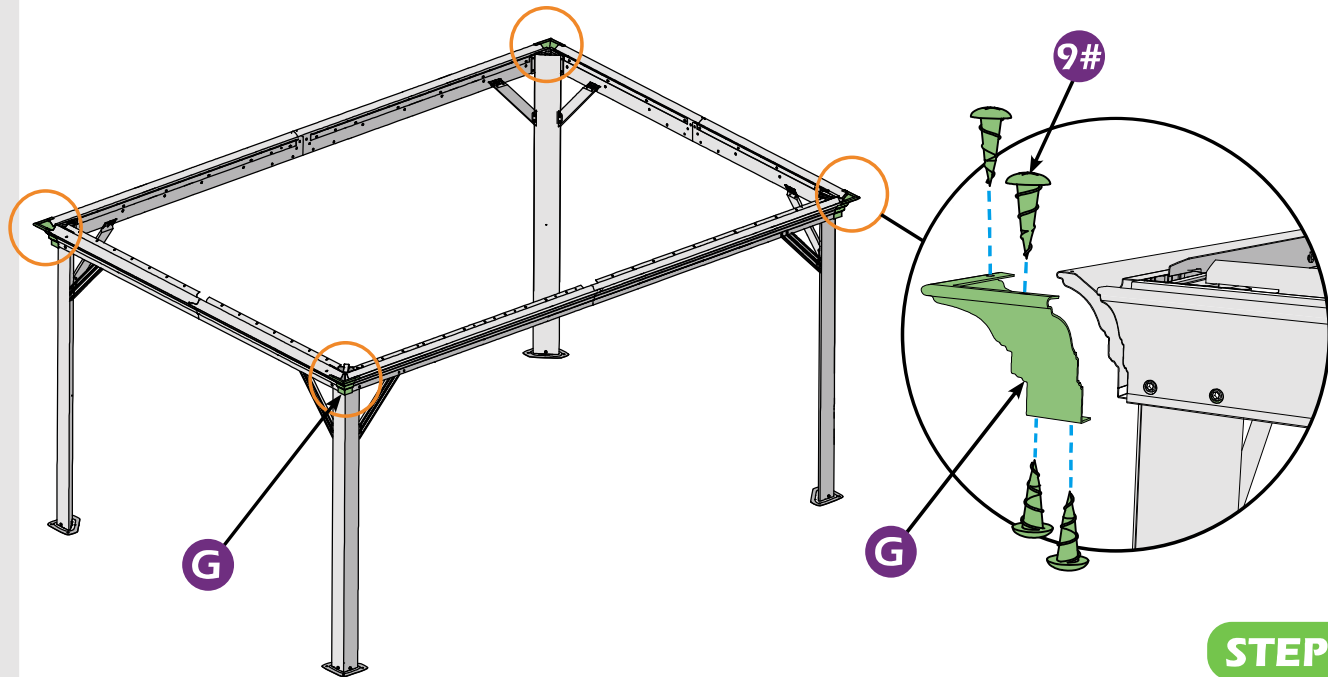
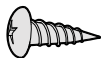

STEP 1



STEP 2



K × 1

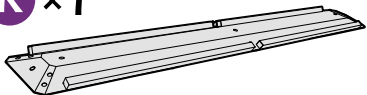

K1 × 1

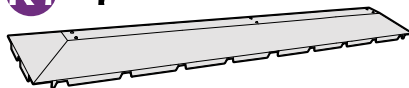

1# × 3

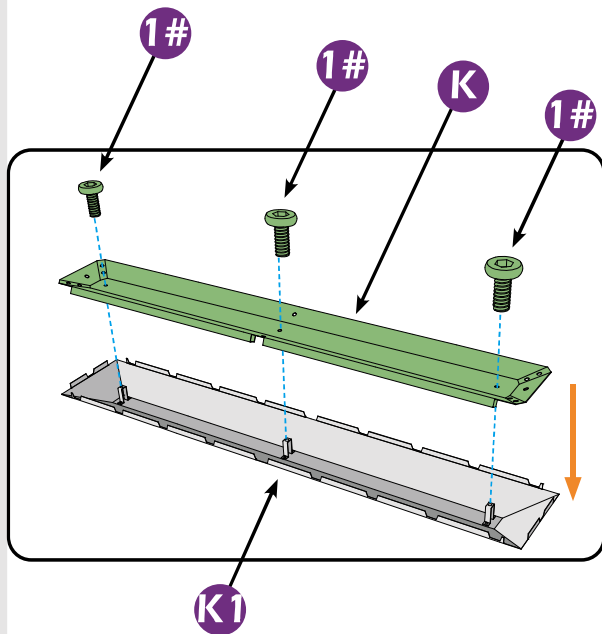
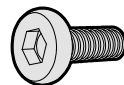

Don't fully tighten the screw 1#. It might cause problems on roof's installation.

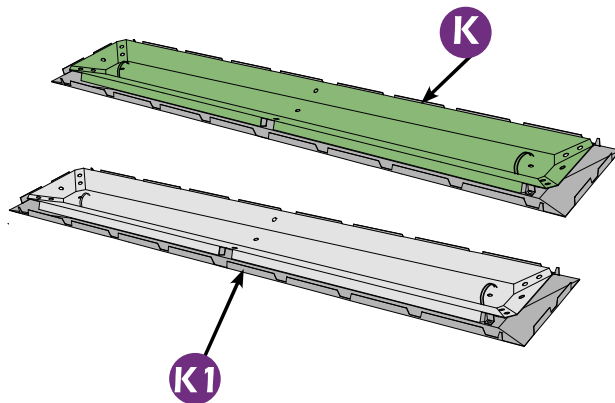

STEP 2



M × 1

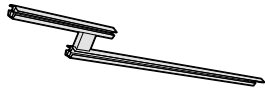

N × 1



1# × 3

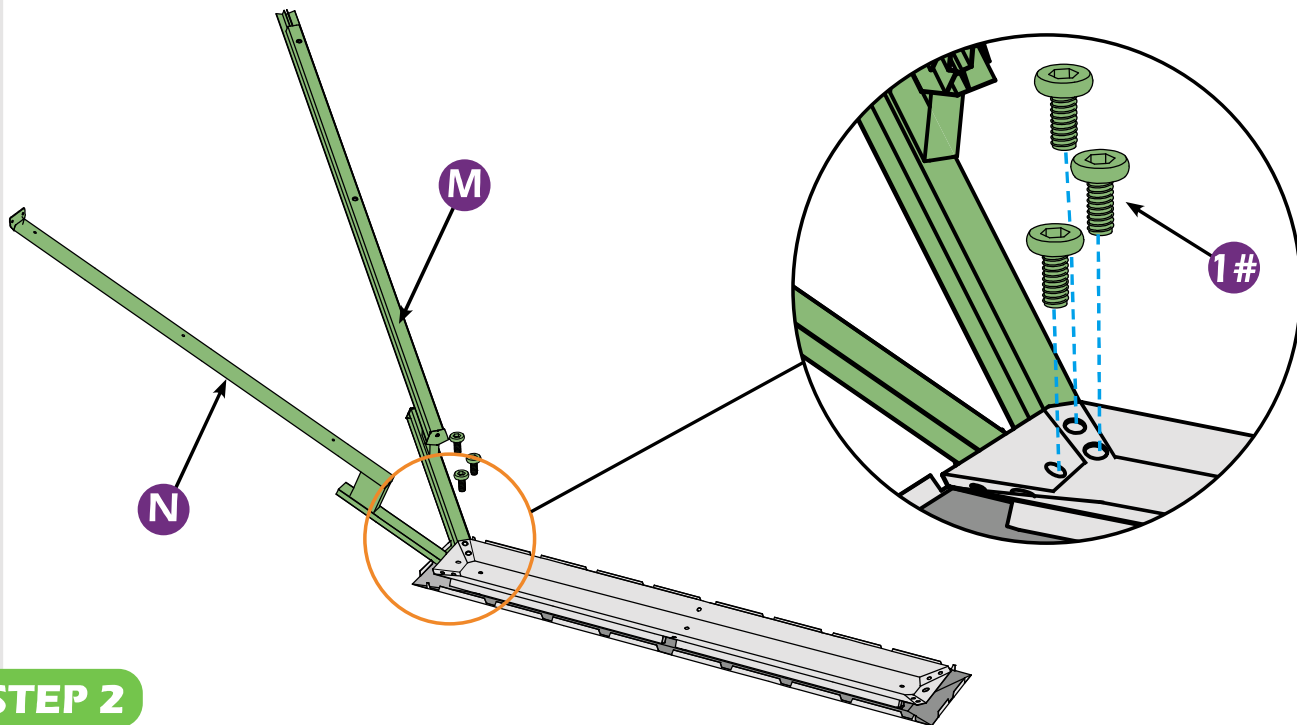
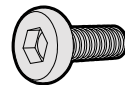

STEP 2



1#×3

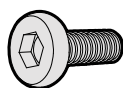

One person needs to hold the part **K** & **K1** as picture shows.

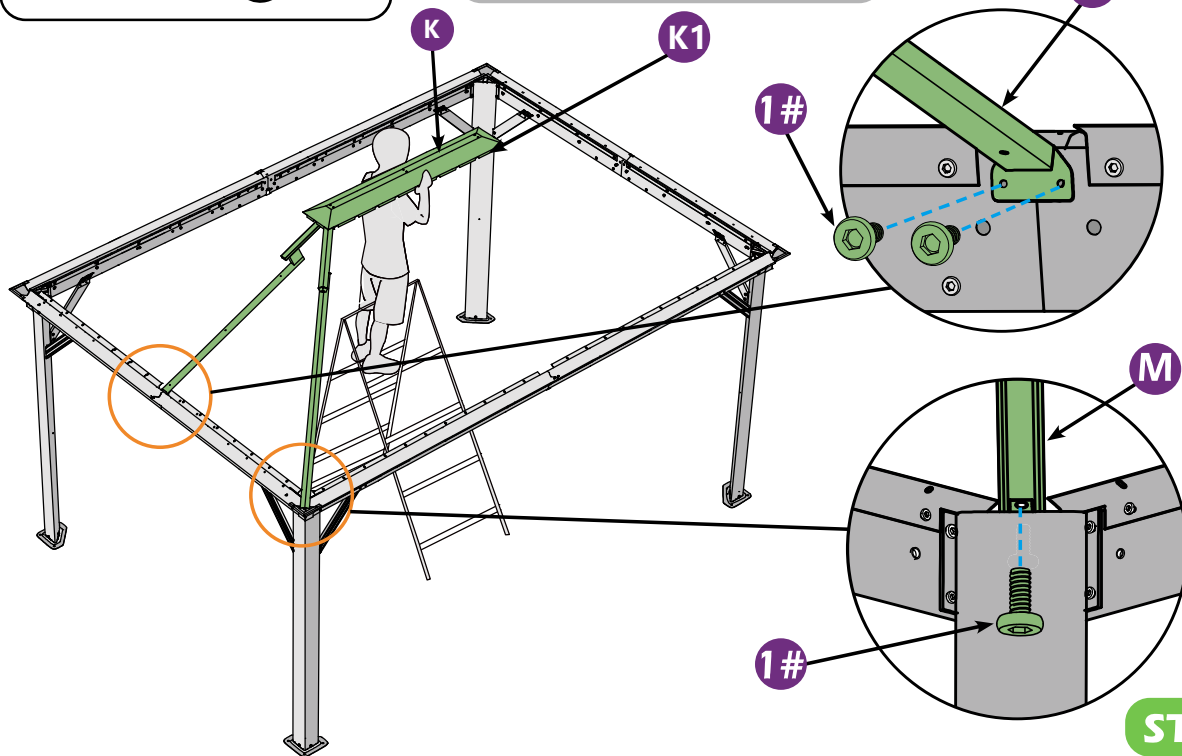

STEP 2



M × 3

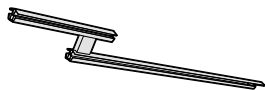

1# × 9

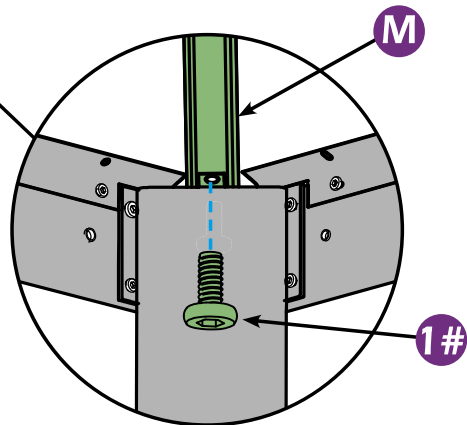
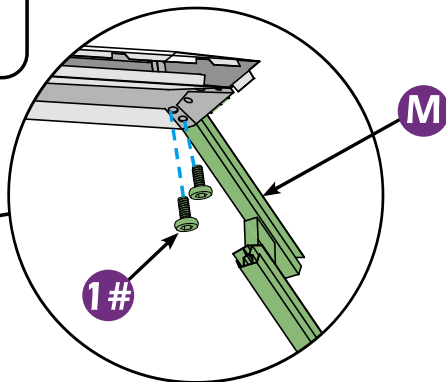
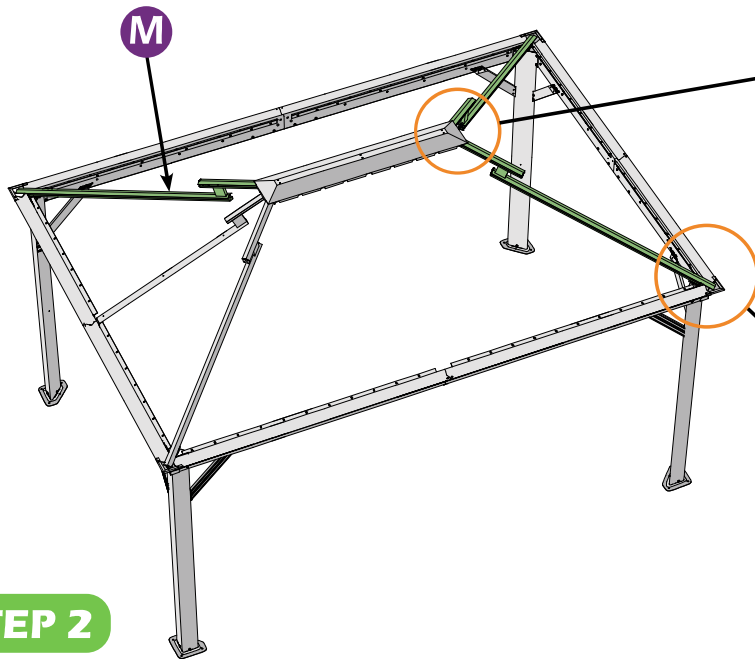
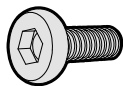

STEP 2



N × 1



1# × 3

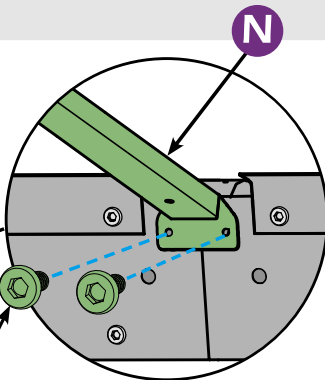
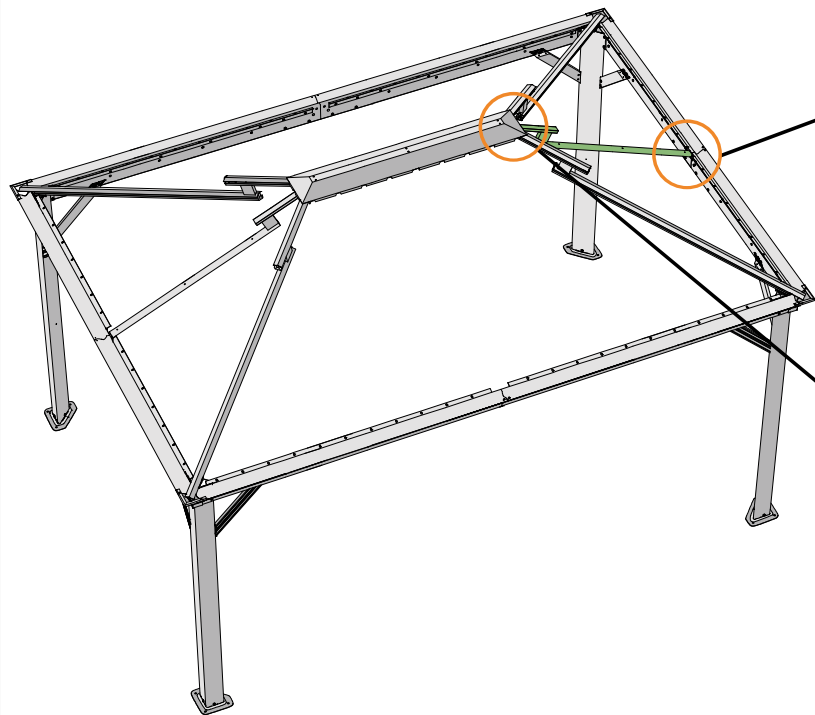
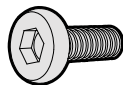

1#

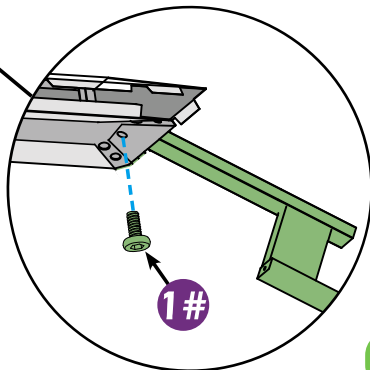

1#

STEP 2

Check if the frame shows as pictures below.

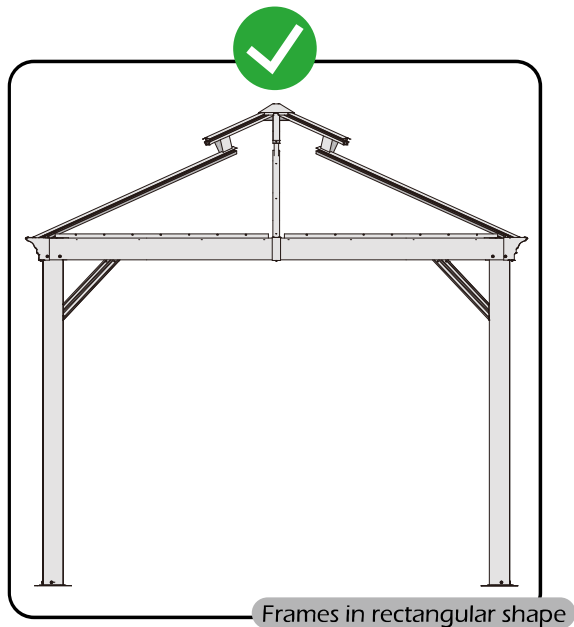
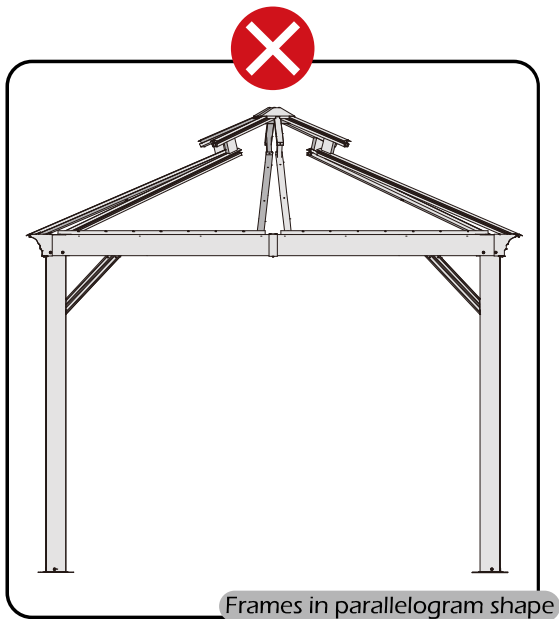

STEP 2



N × 2



1# × 6

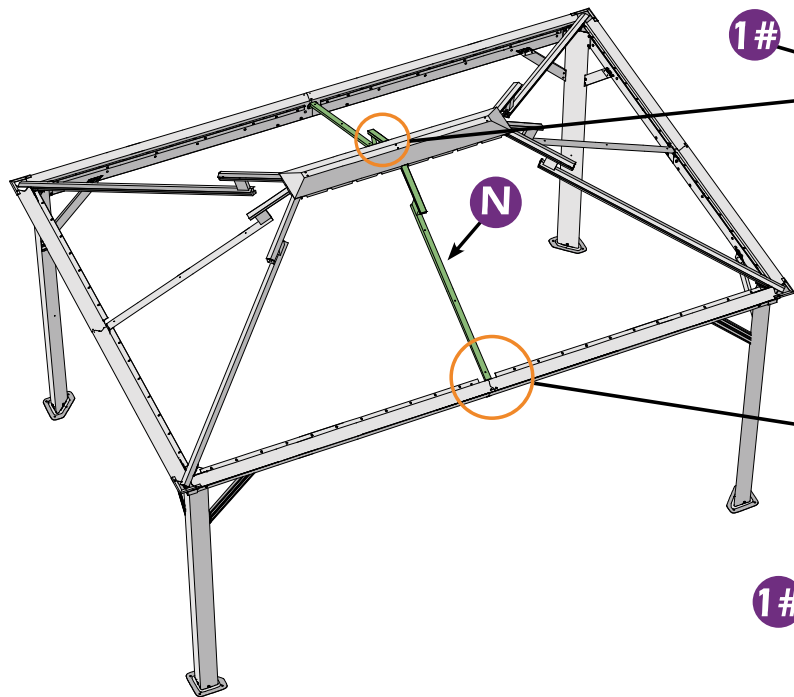
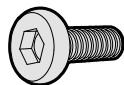

1#

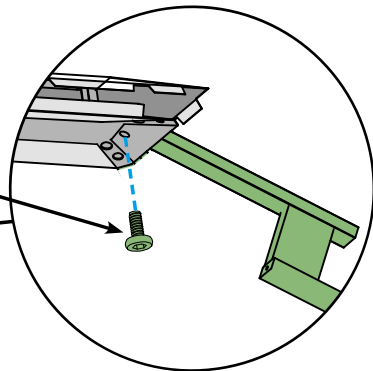

1#

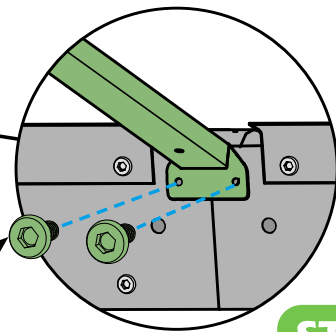

STEP 2



P × 2



R × 4

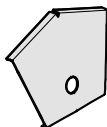

1# × 8

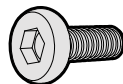

Q × 2

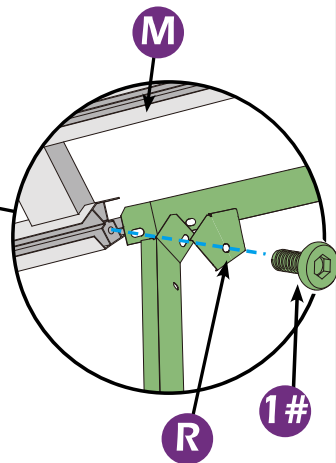
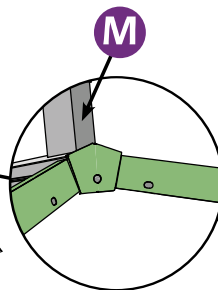
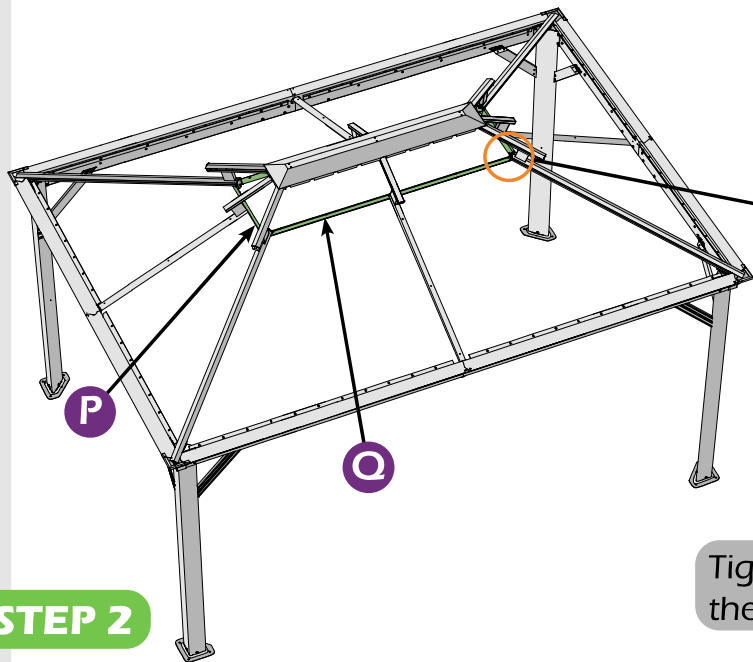

Tighten the the screws on the corners.

STEP 2



P1×2



Q1×2



Q2×2



1#×4



11#×8

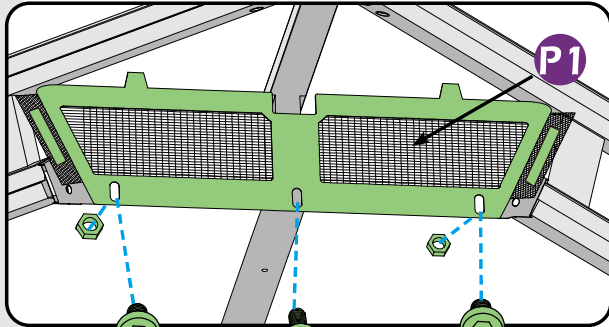

Install the netting and the screw in the middle.

11#

1#

11#

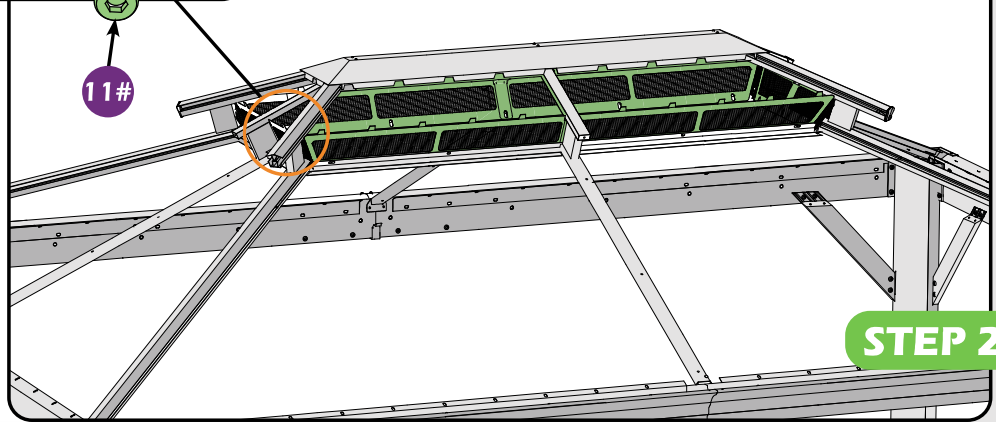

STEP 2

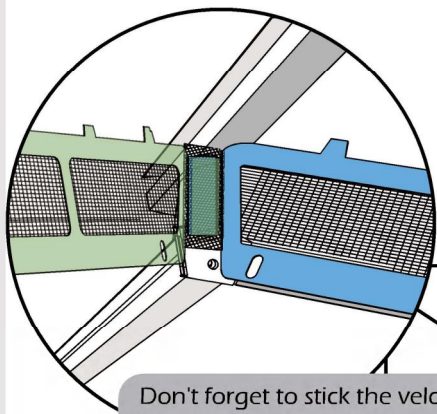

Don't forget to stick the velcro between the bug netting.

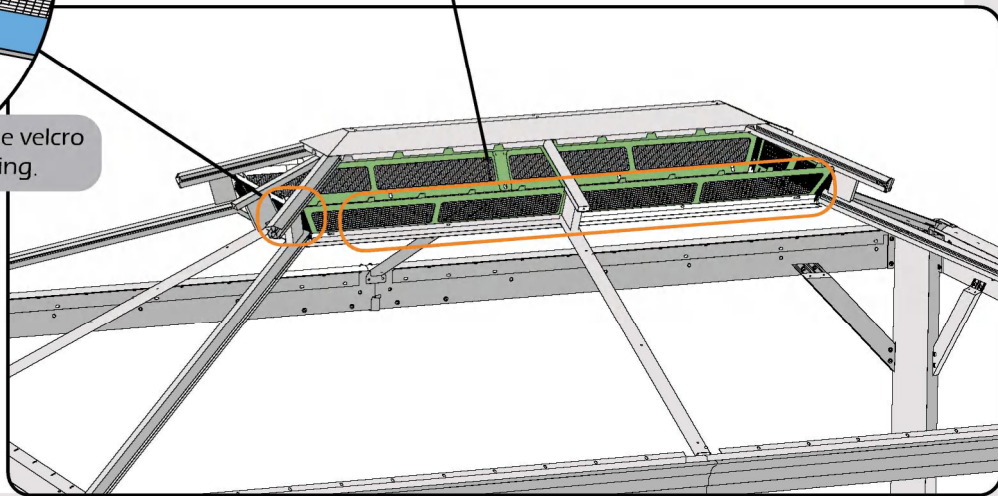
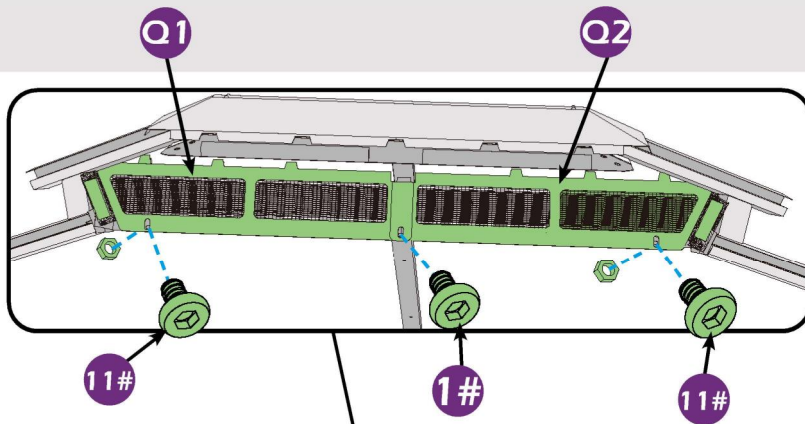

STEP 2



T1 × 2



R × 4

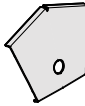

1# × 8

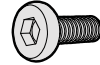

T2 × 2

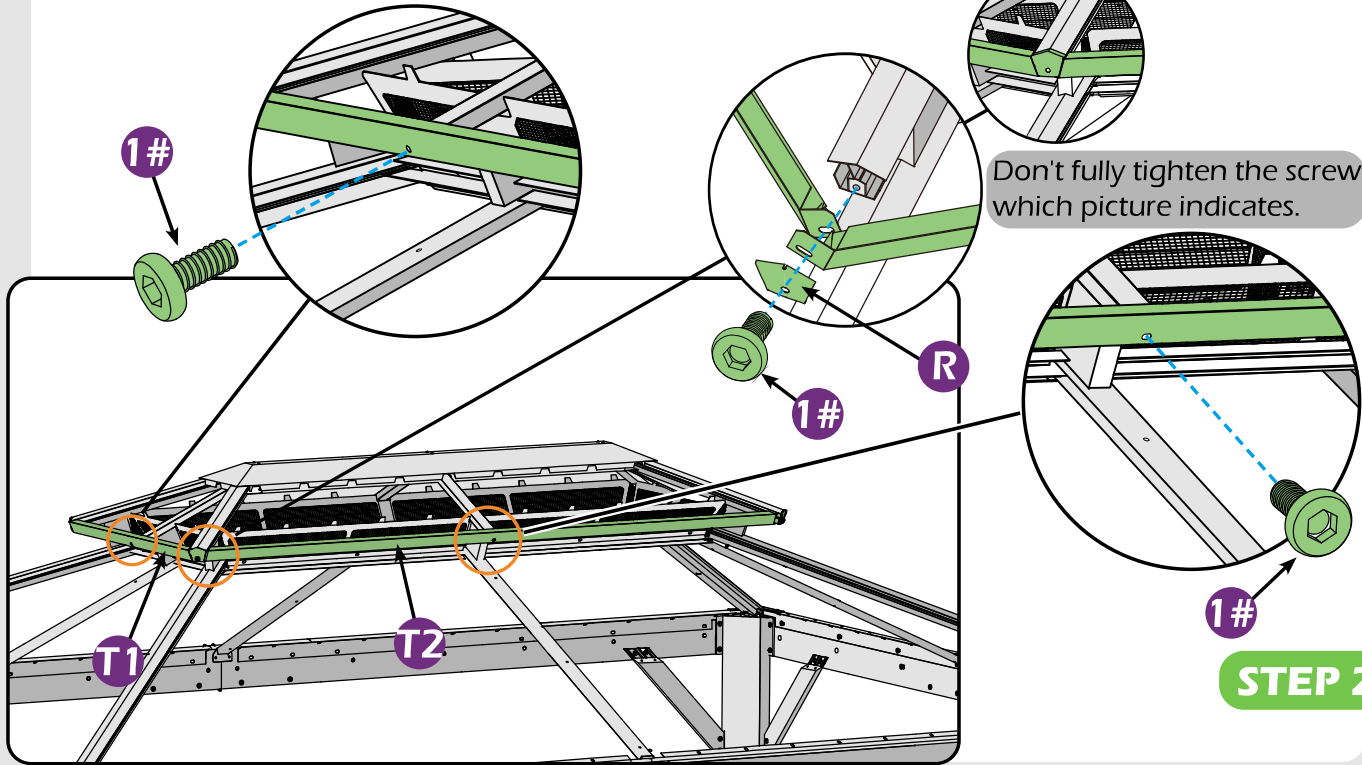

STEP 2

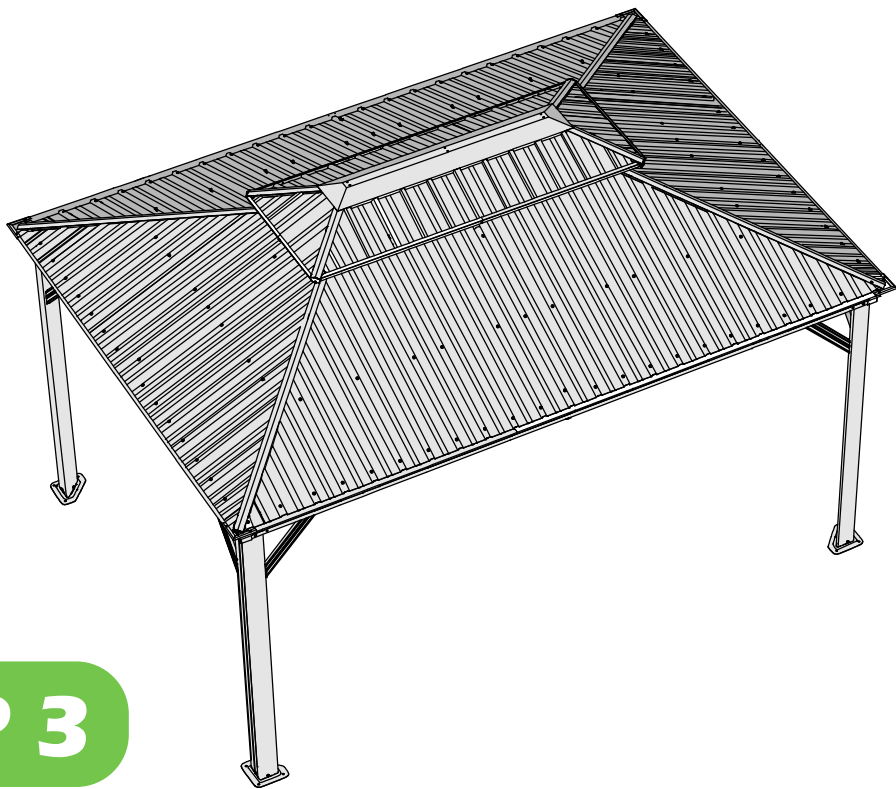

STEP 3



V1 x 2



V3 x 2

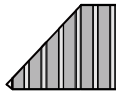

V4 x 4

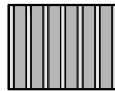

Z1 x 2



V2 x 2



V5 x 2

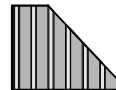

Z x 12



Z2 x 2

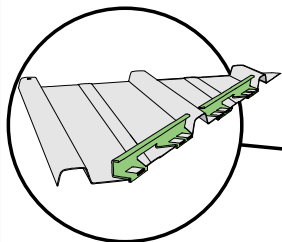

Z1

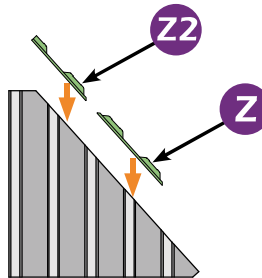

Z

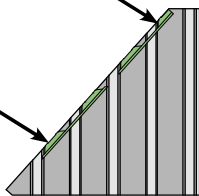

V2

V1

Z

Z

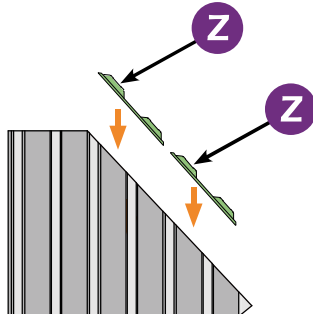
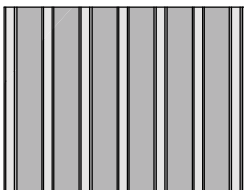
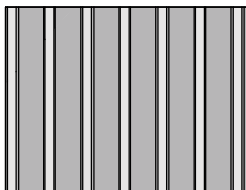
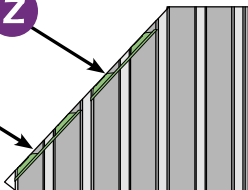

V3

V4

V4

V5

STEP 3

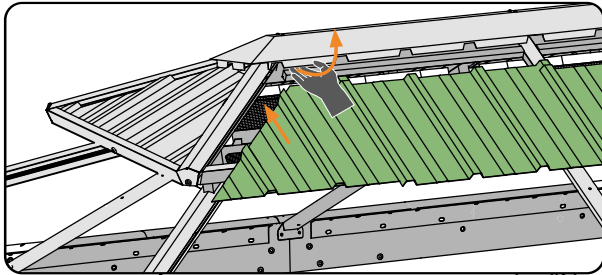

If you can't install **V3** or **V5**, push the part **K1** up and try to insert them again.

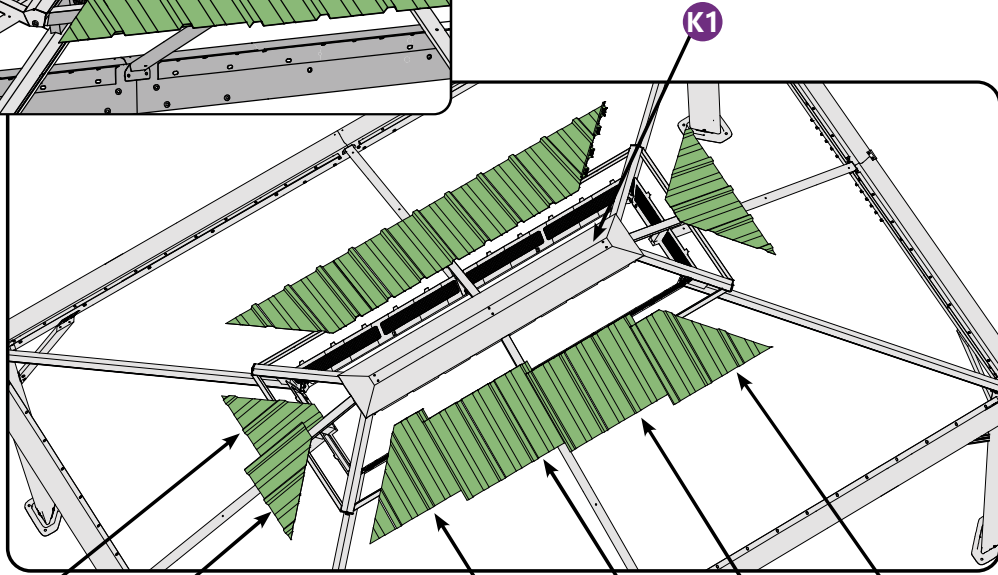

STEP 3

- V1**
- V2**
- V3**
- V4**
- V4**
- V5**

1#

Fully fasten the 1# bolts in K & K1.

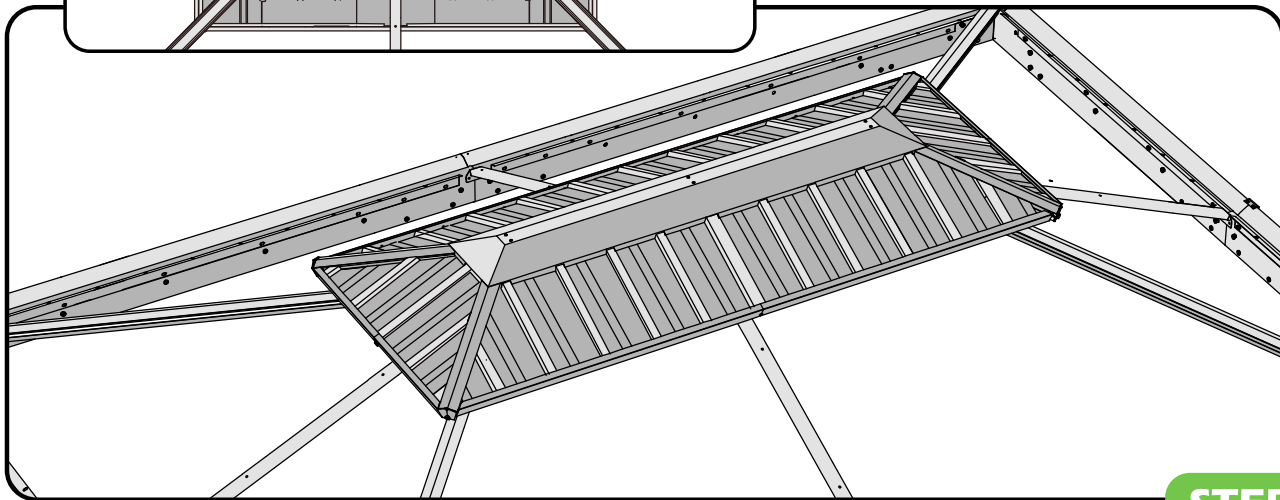
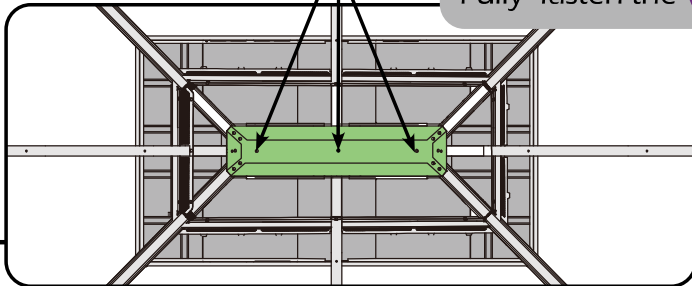

STEP 3



U1 × 4

U3 × 4

U4 × 4

U2 × 4

1# × 24

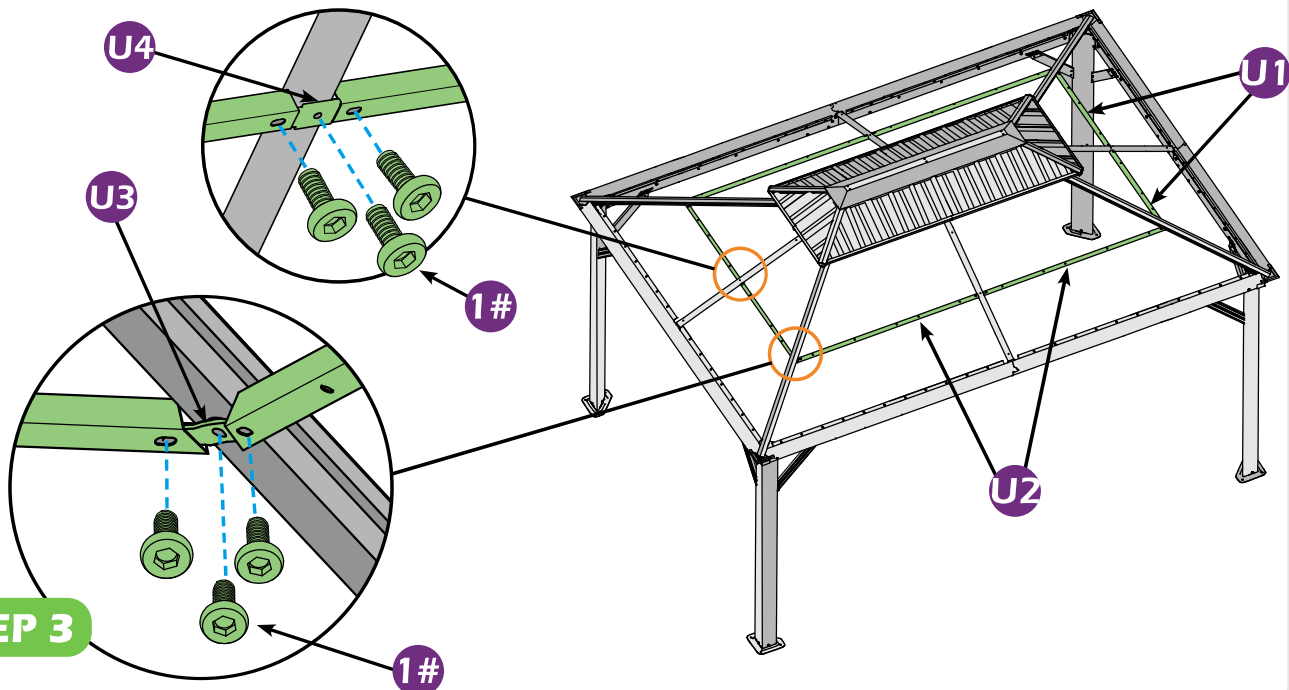

STEP 3





W1 x 2 

W2 x 2 

W3 x 2 

Z x 24 

W6 x 2 

W5 x 2 

W4 x 2 

Z3 x 2 

Z4 x 2 

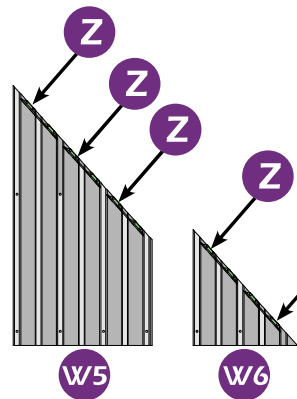
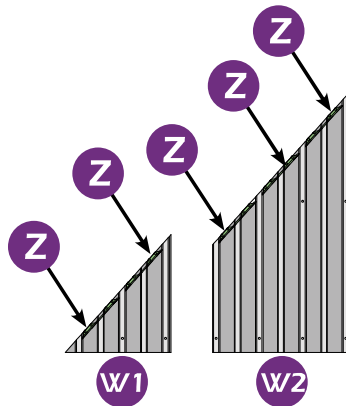
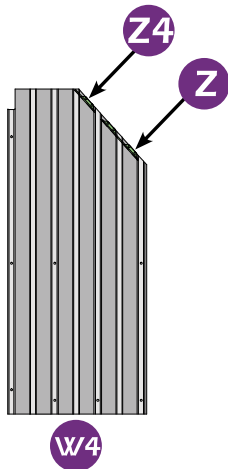
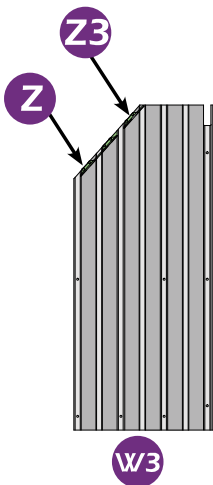

STEP 3



X1×2



X2×2



X3×2



X4×2



Z×20



Z1×4



X8×2



X7×2



X6×2



X5×2



Z2×4



Z1

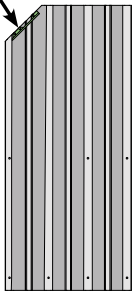

X3

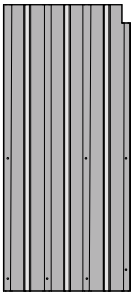

X4

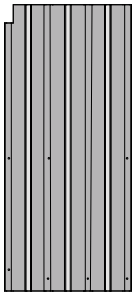

X5

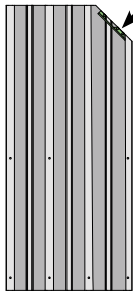

X6

Z2

Z2

Z

Z

Z

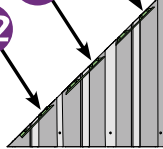

X1

Z

Z

Z

Z

Z

Z

Z

Z

Z

Z

Z

Z

Z

Z

Z

Z

Z

Z

Z

Z

Z

Z

Z

Z

Z

Z

Z

Z

Z

Z

Z

Z

Z

Z

Z

Z

Z

Z

Z

Z

Z

Z

Z

Z

Z

Z

Z

Z

Z

Z

Z

Z

Z

Z

Z

Z

Z

Z

Z

Z

Z

Z

Z

Z

Z

Z

Z

Z

Z

Z

Z

Z

Z

Z

Z

Z

Z

Z

Z

Z

Z

Z

Z

Z

Z

Z

Z

Z

Z

Z

Z

Z

Z

Z

Z

Z

Z

Z

Z

Z

Z

Z

Z

Z

Z

Z

Z

Z

Z

Z

Z

Z

Z

Z

Z

Z

Z

Z

Z

Z

Z

Z

Z

Z

Z

Z

Z

Z

Z

Z

Z

Z

Z

Z

Z

Z

Z

Z

Z

Z

Z

Z

Z

Z

Z

Z

Z

Z

Z

Z

Z

Z

Z

Z

Z

Z

Z

Z

Z

Z

Z

Z

Z

Z

Z

Z

Z

Z

Z

Z

Z

Z

Z

Z

Z

Z

Z

Z

Z

Z

Z

Z

Z

Z

Z

Z

Z

Z

Z

Z

Z

Z

Z

Z

Z

Z

Z

Z

Z

Z

Z

Z

Z

Z

Z

Z

Z

Z

Z

Z

Z

Z

Z

Z

Z

Z

Z

Z

Z

Z

Z

Z

Z

Z

Z

Z

Z

Z

STEP 3

Install the middle panels first (X4, X5 or W3, W4) then the small panels on the edge.

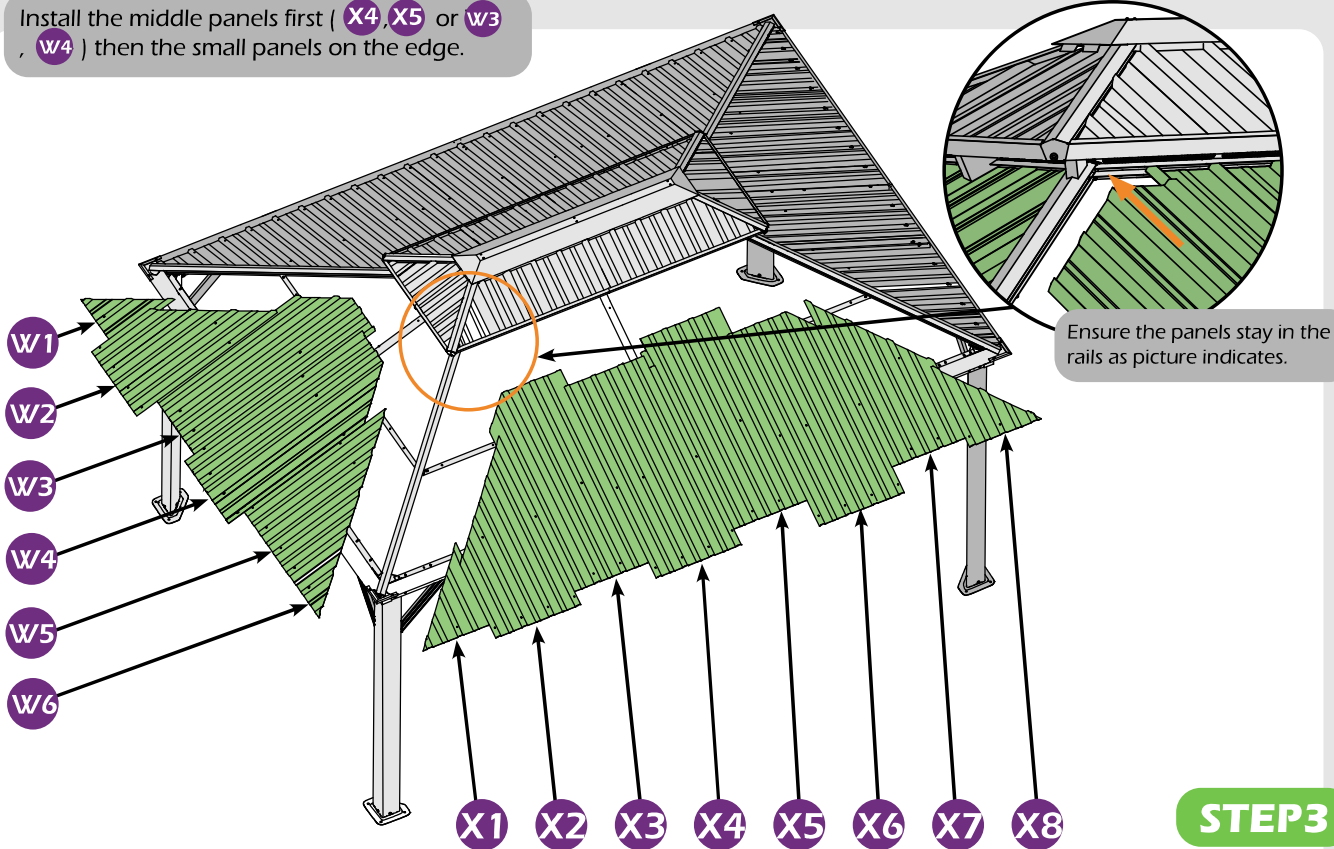

STEP 3



5#×72



10#×4



S×76

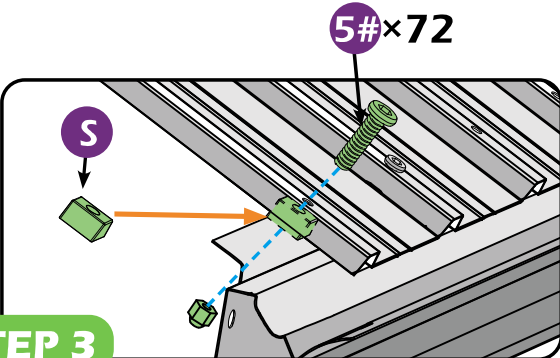
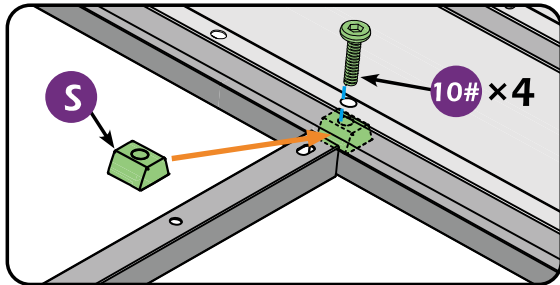

STEP 3

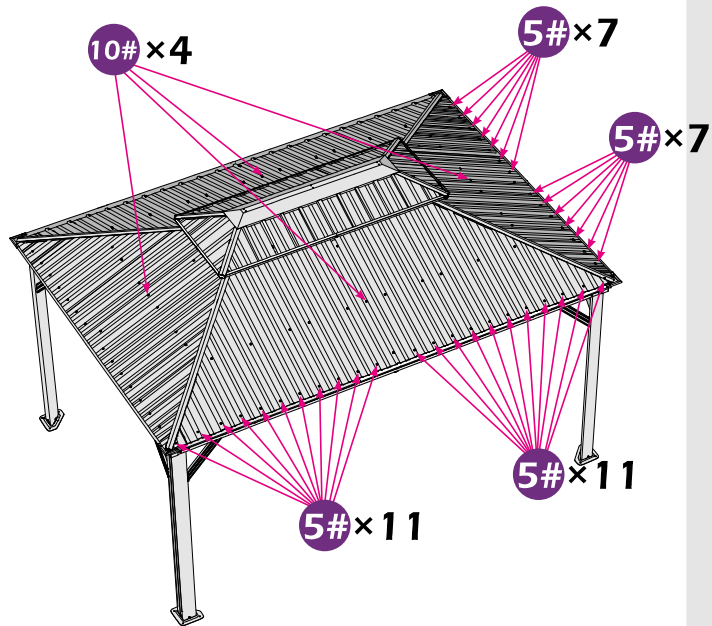



6#×8



7#×32



S×40

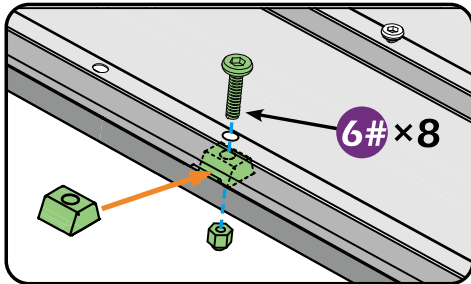
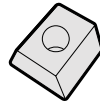

7#×32

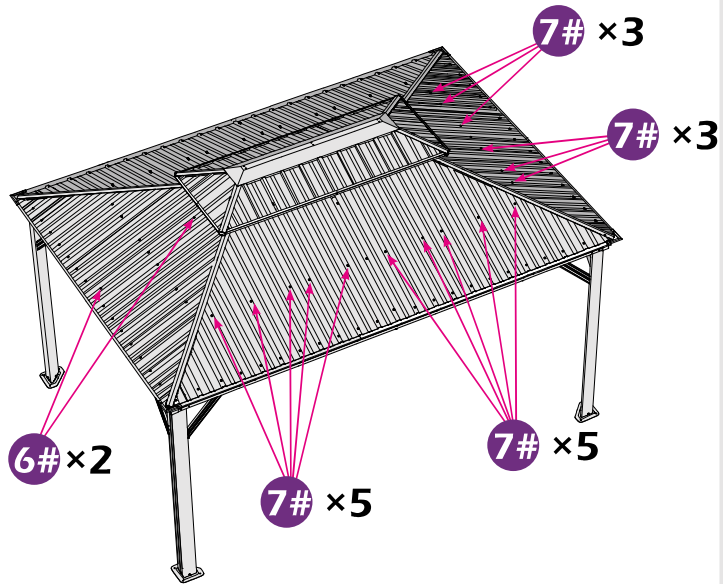
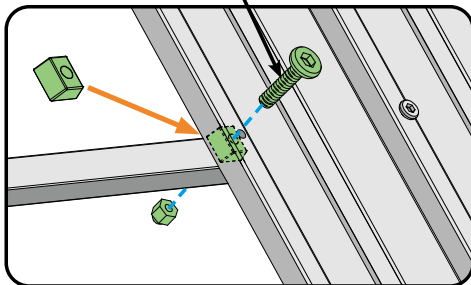

STEP 3

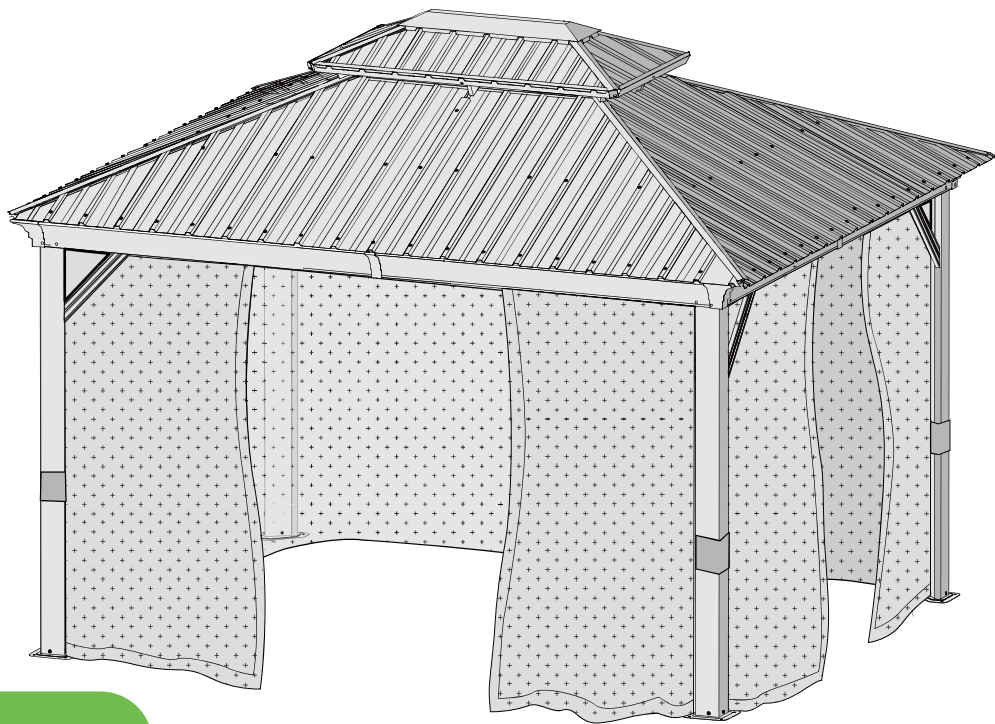

STEP 4



B2 × 2



1# × 16



C2 × 2

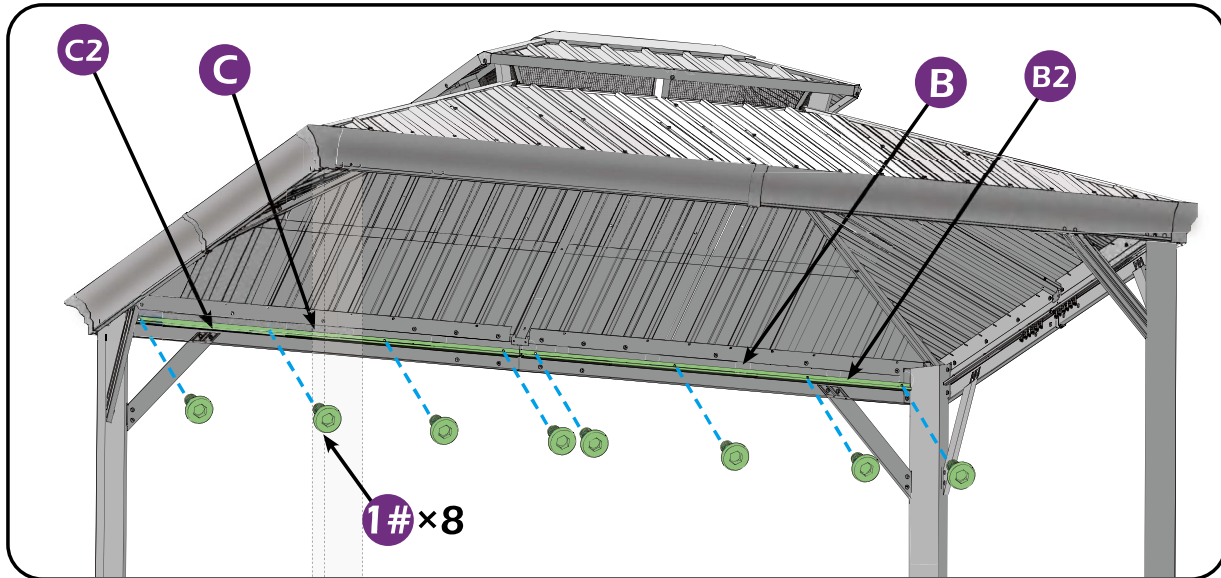

STEP 4



D2 × 2



1# × 24



E2 × 2

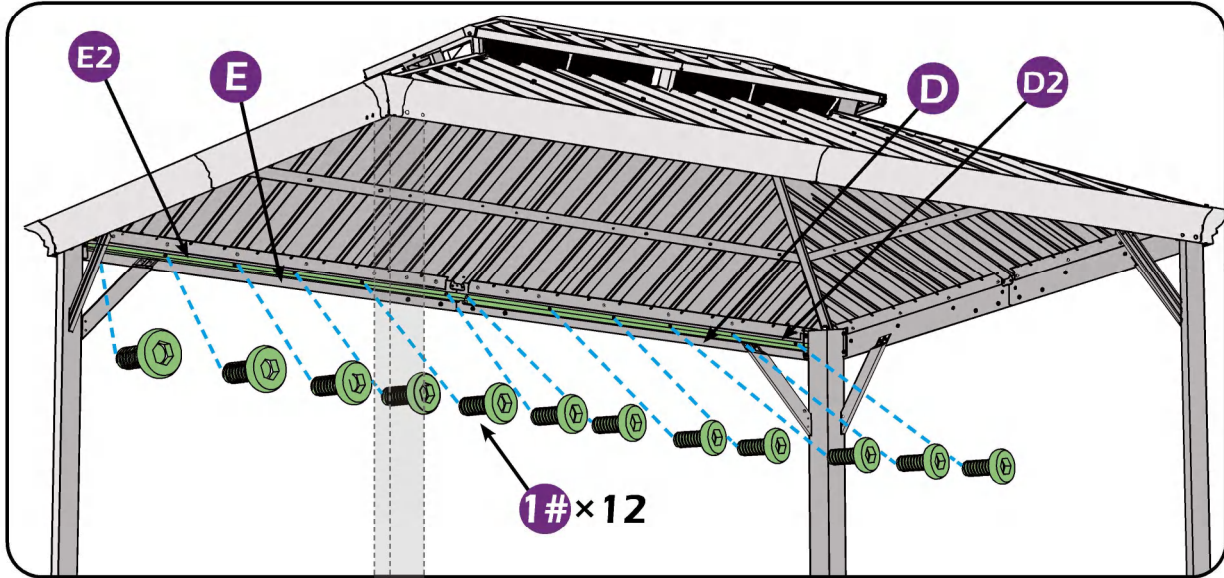

STEP 4



4#×24

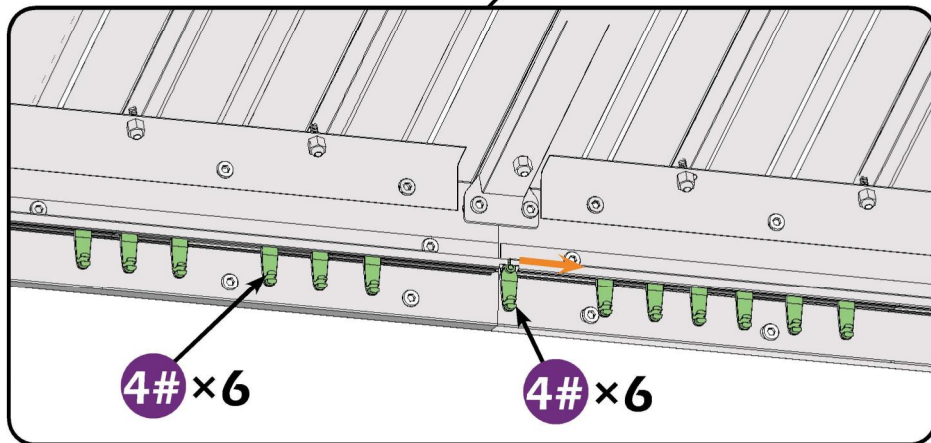
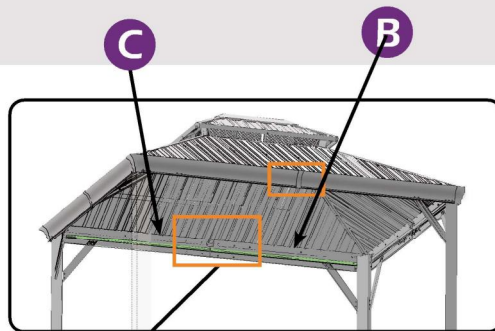

STEP 4



4# × 32

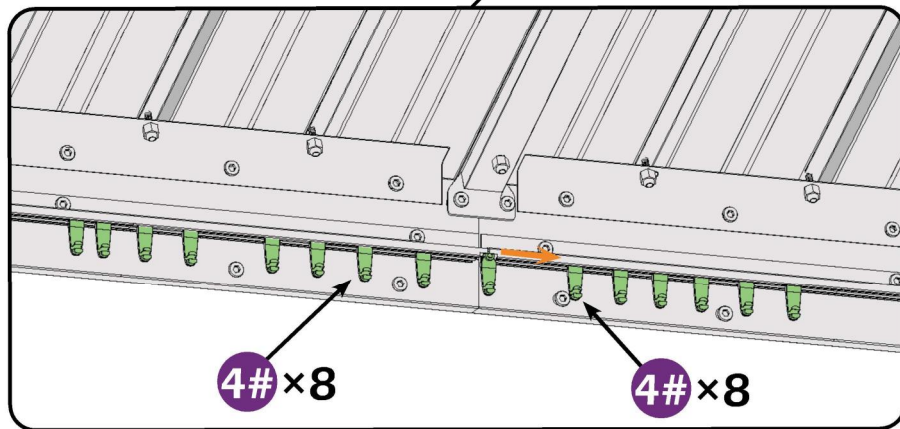
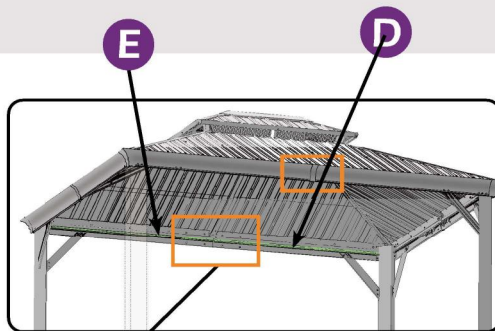

STEP 4



H×4

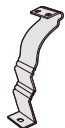

H1×4

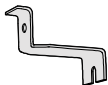

8#×4

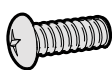

9#×8

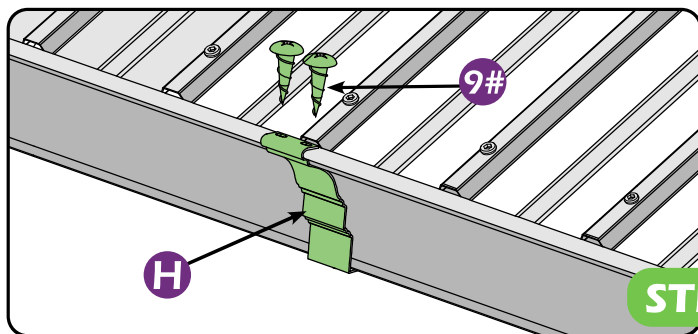
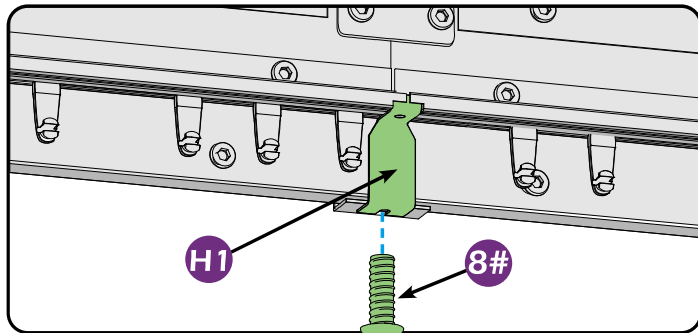
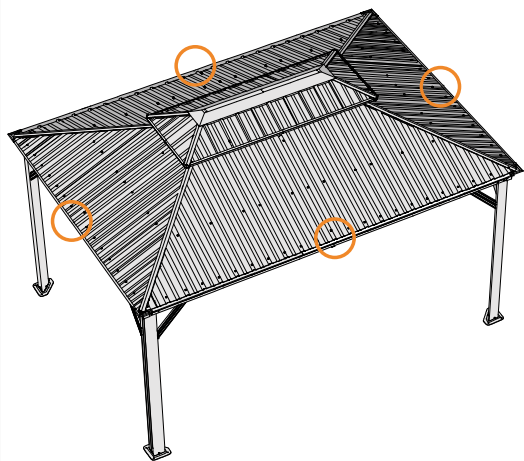
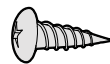

STEP 4



H2 x 1

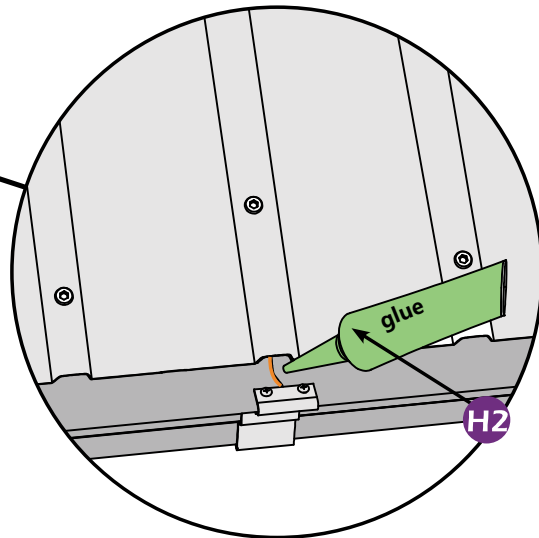
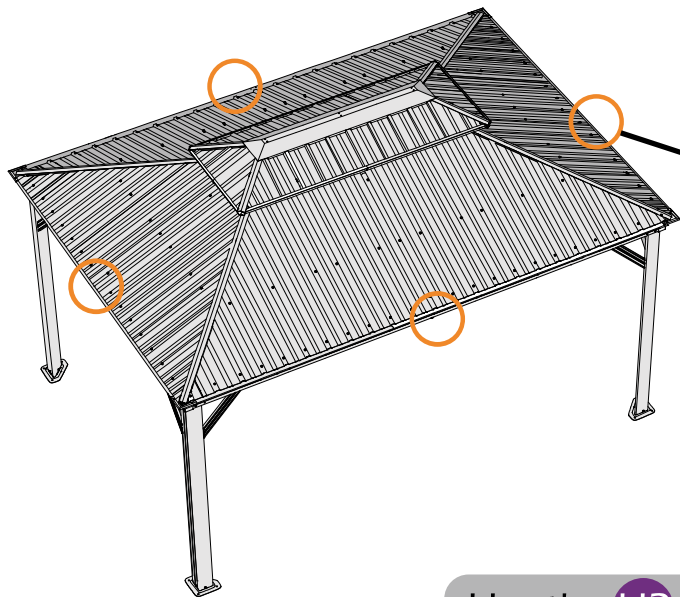

STEP 4

Use the **H2** silicone glue to cover the gap on the gutter.



Y × 4

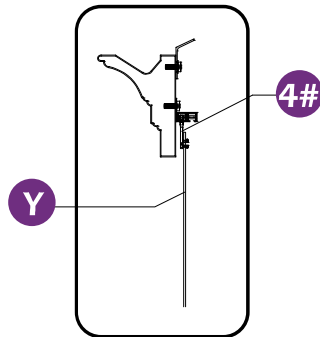
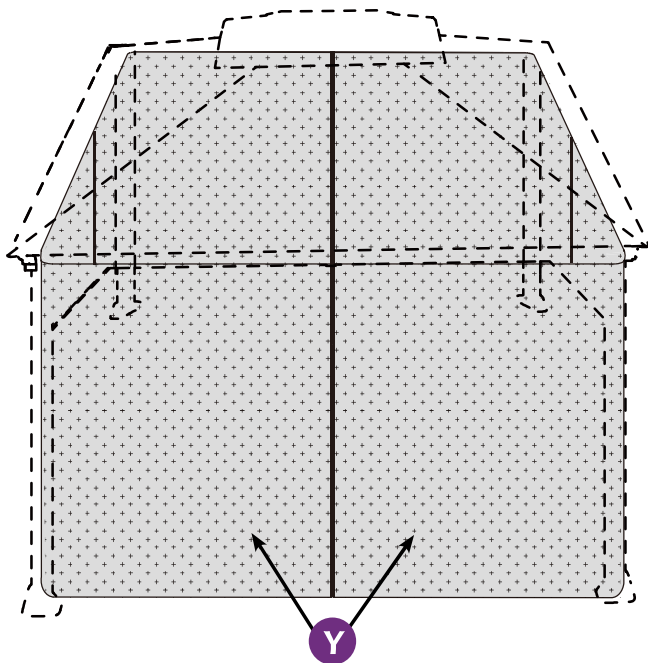
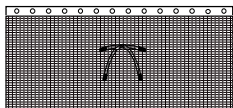

STEP 4

Picture below indicates the number of holes on the netting. Each hole matches to one hook.

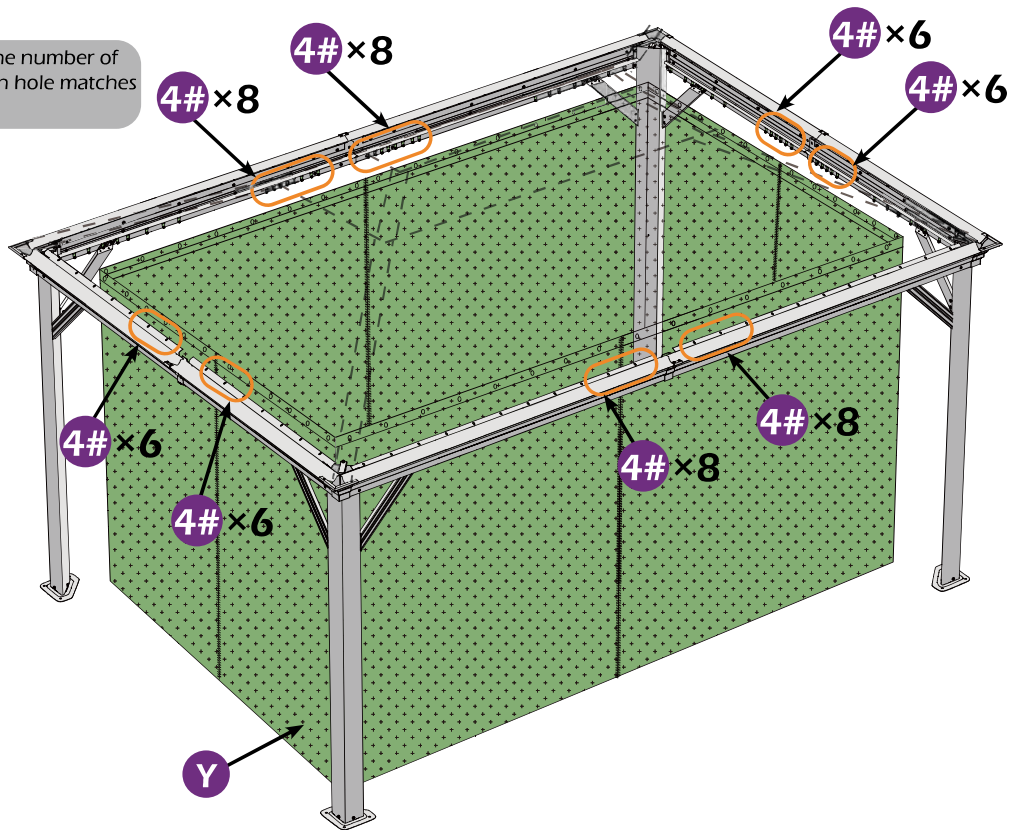

STEP 4

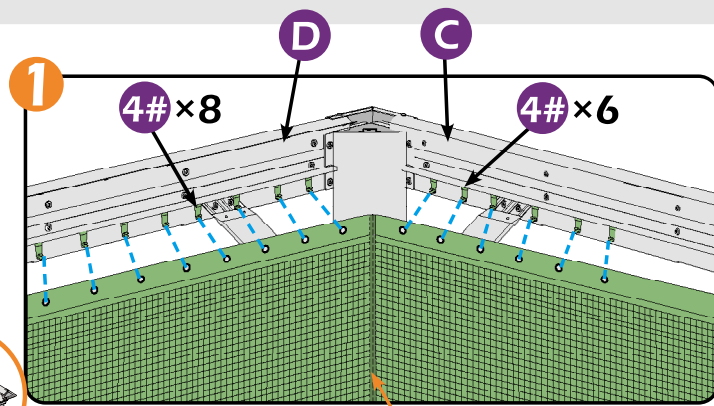
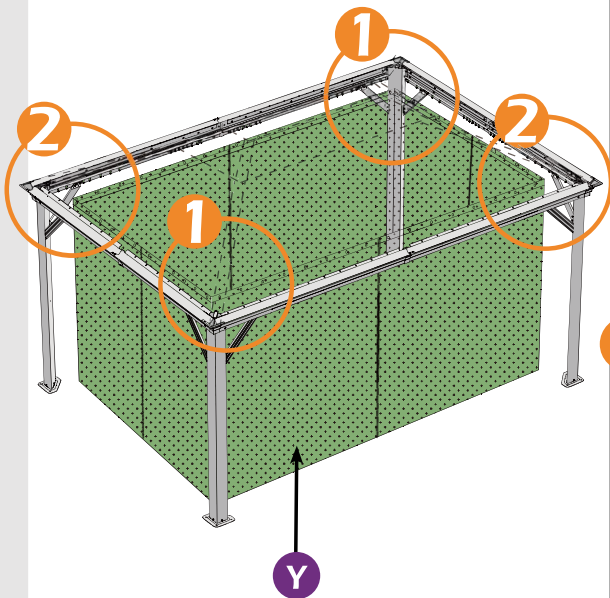

Ensure the suture line is close to the pole.

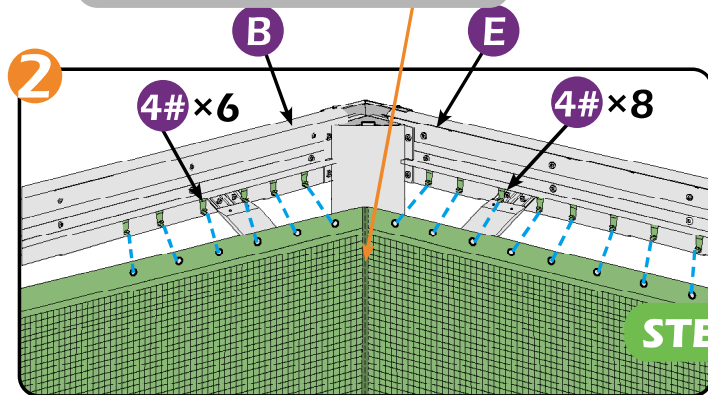

STEP 4

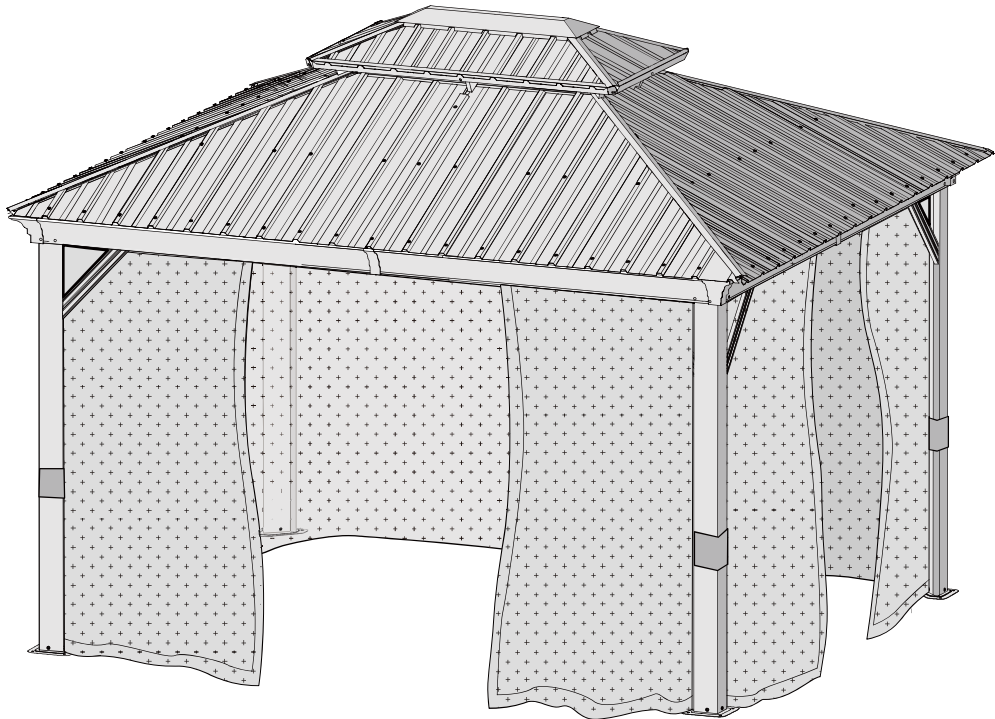

STEP 4

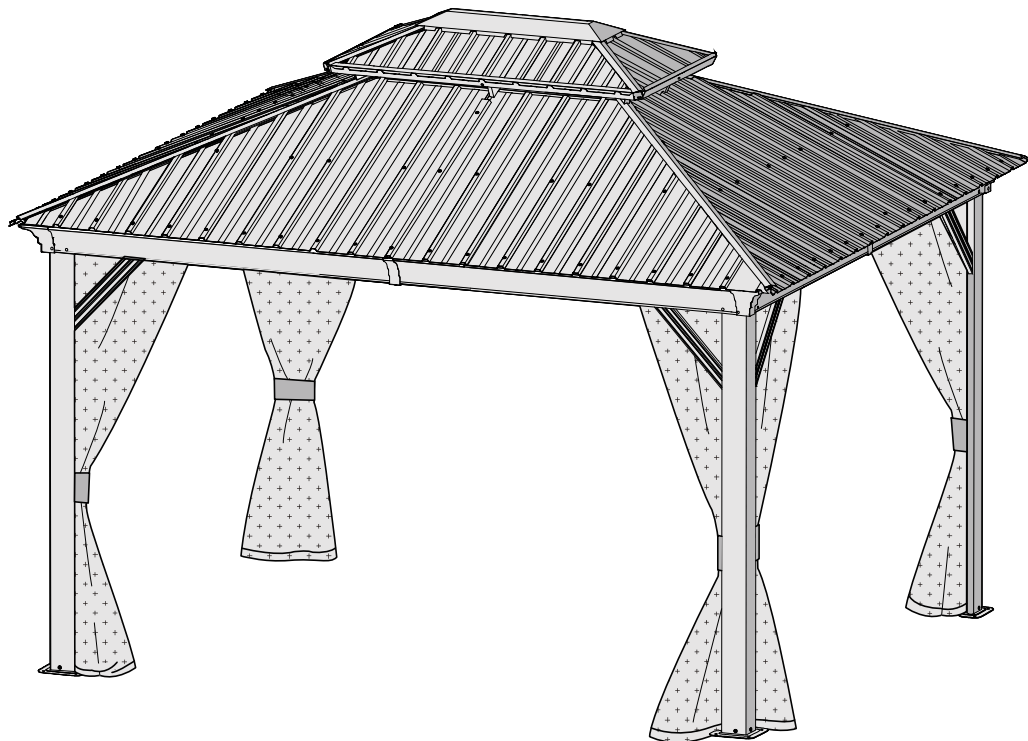

STEP 4

Care and Cleaning

Wash frame parts and fabric with mild soap and water, rinse thoroughly.

Dry frame completely and allow the fabric drip dry.

Do not use bleach, acid, or other solvents on the fabric or frame parts.

Please inspect and tighten all bolts or fasteners on a regular basis to ensure proper performance and safety of your gazebo.

Warranty

Frames

Frames constructions are warranted to be free from defects in material and workmanship for 1 year from item purchased. Damage to frame from negligence won't be covered by this warranty.

Bolts & nuts

Bolts and nuts are warranted to be free from defects in material and workmanship for 1 year from item purchased. Damage from exposure to chemicals (including but not only oils, spills, fluids) won't be covered by this warranty.

Curtains & Netting

Curtains and netting are warranted to be free from defects in material and workmanship for 1 year from item purchased. Damage from exposure to chemicals (including but not only oils, spills, fluids) won't be covered by this warranty.

Warranty Limitation

This warranty is for the original purchase order only (Order number required). This warranty is non-transferable. Purple Leaf is responsible for the free replacement parts including shipping charges for the 1 year warranty.

Warranty Exclusion

This warranty does not cover situation subject to negligence, abuse usage, inappropriate installation, extreme weather condition. Purple Leaf reserves the right to explain warranty exclusions. When the replacement item is applied, the 1 year warranty automatically expires. Please feel free to contact us for applying warranty.

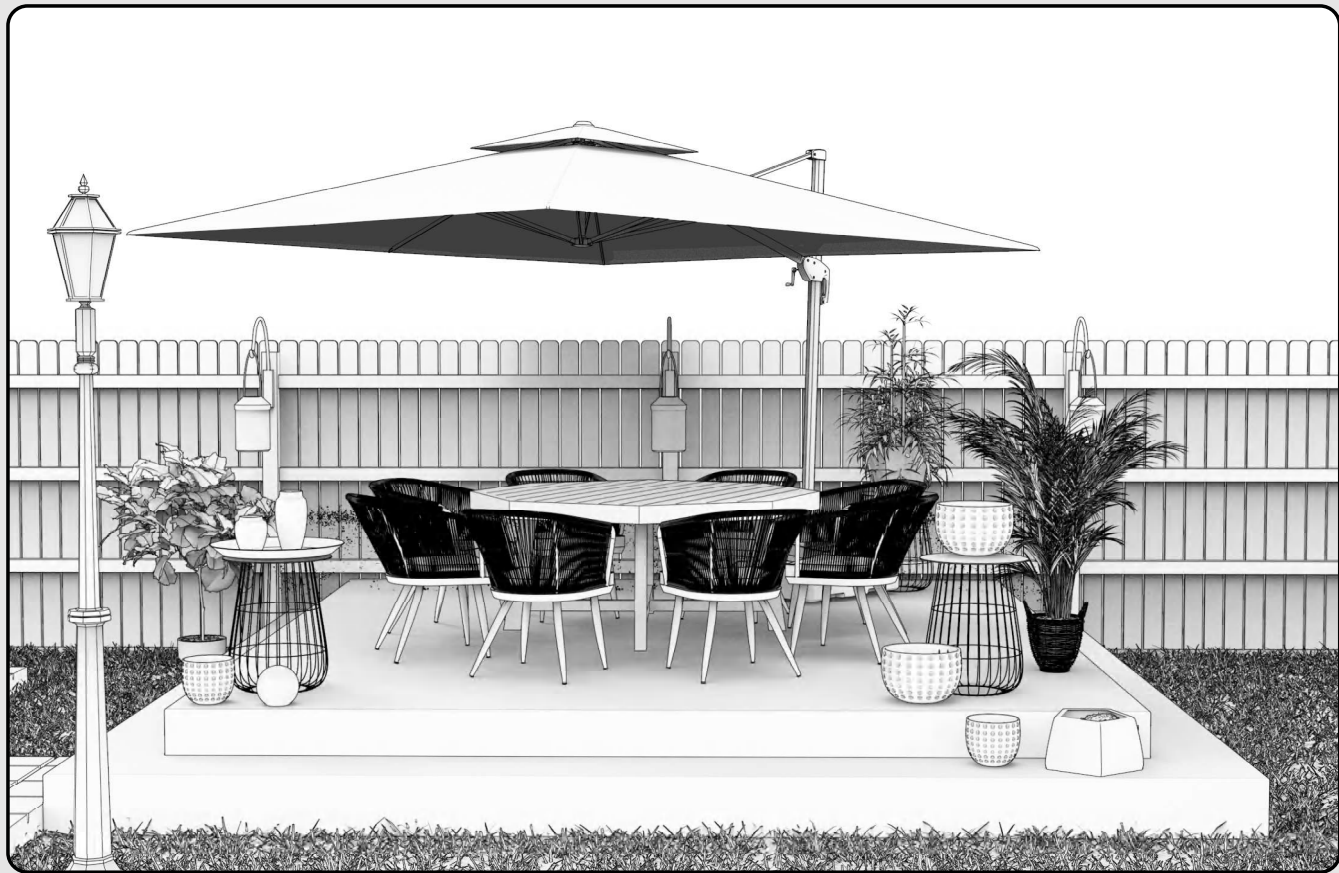





Purple Leaf Inc.
1820 E Locust St, Ontario
CA, 91761, US
gazebo4@purpleleafgarden.com
©Copyright 2016-2023 Purple Leaf Inc.
All Rights Reserved