

EXPRESS WATER



INSTALLATION MANUAL



For installation videos go to youtube.com/expresswatervideo

CONNECTION POINTS

(See page 16 for more information.)

A to B Connect the RED Tubing to the Feed Water Adapter Valve (A), then to the connection marked as "IN" on the Leak Stop Valve (B).

C to D Connect the WHITE Tubing to the connection marked as "OUT" on the Leak Stop Valve (C), then to the Sediment Filter Housing's Male Elbow Fitting (D).

G to H Connect the BLACK Tubing to the Flow Restrictor side indicated by the arrow on the Restrictor (G), then to the Drain Saddle (H).

I to J Connect the YELLOW Tubing to the Inline Post Carbon Filter's Stem Run Tee (I), then to the Storage Tank Valve (J).

K to L Connect the BLUE Tubing to the Stem Elbow at the end of the Inline Post Carbon Filter (K), then to your RO Faucet connection (L).

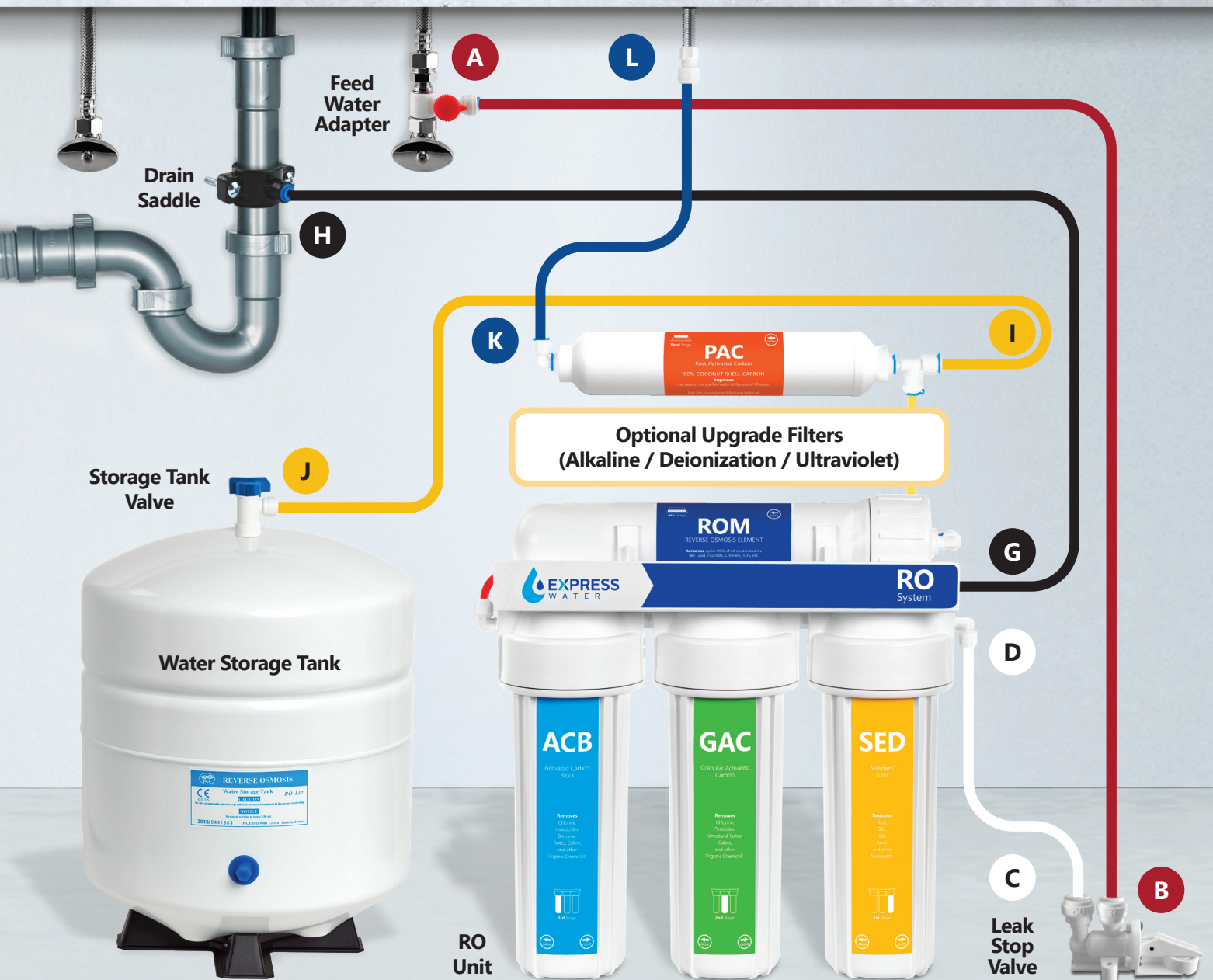

INTRODUCTION

You have purchased the finest residential Reverse Osmosis Water System available for your home. Your drinking water is going to be healthier and taste better from now on, and nothing makes us happier. When properly maintained this system will provide you with years of great-tasting, pure drinking water and trouble-free service.

Getting started is a breeze - most of your Reverse Osmosis System is already assembled and every connection is color coded. We've marked where the colored tubes will go with matching colored plugs in each fitting.

Please make sure to thoroughly read the installation manual and become familiar with the tools needed before proceeding with the installation. Also, please make sure to inspect the package for any missing components or shipping damages.

If you find any issues or have questions please contact us at **1-800-992-8876** or visit our website at www.expresswater.com.



TABLE OF CONTENTS

Introduction	P. 3
Table Of Contents	P. 3
Performance Data Sheet / Technical Specifications	P. 4
Conditions	P. 5

INSTALLATION

Installation Notes & Components List	P. 6
System Components	P. 7
Tubing Quick Connect Guide	P. 8
Feed Water Adapter Valve	P. 9
RO Faucet	P. 10-11
Drain Saddle	P. 12
Automatic Shutoff Valve	P. 12
Housing Assembly	P. 13
Elbow Fitting Installation	P. 13
Gauge Installation	P. 14
Ultraviolet Sterilizer Installation	P. 14
Leak Stop Valve	P. 15
Water Storage Tank	P. 15
System Connections	P. 16

SYSTEM STARTUP

System Startup	P. 16
System Maintenance	P. 17
How to Sanitize your RO System	P. 17
Filter Change Instructions	P. 18-19
Restarting The System	P. 19

FAQs	P. 20
Troubleshooting	P. 21
Express Water Upgrades & Accessories	P. 22
Warranty	P. 23
Replacement Filters / Replacements Table	P. 24



PERFORMANCE DATA SHEET

Tested and Certified by NSF International against NSF/ANSI 58 for TDS Reduction - Models **RO5DX** & **RO10DX**



Model	Operating Pressure	Operating Temperature	Recovery Rating	Efficiency Rating	Daily Production
RO5DX	50-100 PSI 344-689 kPa	40-100°F 5-38°C	16.17%	17.44%	12.22 GPD
RO10DX	50-100 PSI 344-689 kPa	40-100°F 5-38°C	17.10%	9.66%	21.89 GPD

Express Water RO5DX and RO10DX have been tested according to NSF/ANSI 58 for reduction of the substances listed below. The concentration of the indicated substances in water entering the system was reduced to a concentration less than or equal to the permissible limit for water leaving the system, as specified in NSF/ANSI 58.

NSF/ANSI 58 Substance	Avg. Inf. mg/L	Avg. Eff. mg/L	% Reduction	Max. Eff. mg/L	Inf. Challenge Concentration mg/L	Max. Permissible Concentration mg/L
TDS (RO5DX)	770	36	95.40%	47.00	750 ±40 mg/L	187
TDS (RO10DX)	770	36	95.40%	43.00	750 ±40 mg/L	187

- Do not use this system with water that is microbiologically unsafe or of unknown quality without adequate disinfection before or after the system.
- Testing was performed under standard laboratory conditions, actual performance may vary.
- See owner's manual for general installation/operation/maintenance conditions and needs as well as manufacturer's limited product warranty.
- Efficiency rating means the percentage of the influent water to the system that is available to the user as reverse osmosis

treated water under operating conditions that approximate typical daily usage.

- Recovery rating means the percentage of the influent water to the membrane portion of the system that is available to the user as reverse osmosis treated water when the system is operated without a storage tank or when the storage tank is bypassed.
- This is a factory specification for membrane production. Actual production rate and TDS rejection will depend on temperature, water pressure, TDS level, membrane variation and usage pattern.

TECHNICAL SPECIFICATIONS



RO System

ION System

ALK System

UV System

ALK & UV System

Filtration Stages	5-Stage	6-Stage	10-Stage	6-Stage	11-Stage
Weight	11.8 lbs	12.8 lbs	12.8 lbs	12.8 lbs	13.8 lbs
Dimensions (Inch)	17 x 15.5 x 5	18 x 15.5 x 5	18 x 15.5 x 5	18 x 15.5 x 5	20 x 15.5 x 5
Faucet Flow Rate	0.8 Gallons per Minute				
Max PPM	1000 PPM (Parts Per Million) - Note: Mg./L is the same as PPM				
Production Rate	50-100 Gallons per Day				
Pressure Range	45-80 PSI				
Temperature Range	40-100°F (5-38°C)				
Water Tank Size	(Standard) 4 Gallon Volume / 3.2 Gallon Water Capacity / 12"x 17"H (Including stand and tank valve)				
Water Discharge	1-3 Gallons per Gallon Produced				
Warranty	1-Year Limited Warranty (excludes wear and tear components)				



CONDITIONS READ THIS FIRST!

Please pay attention to the following installation and safety recommendations read the manual before installing this system.



NOTE! Please make sure your installation location has enough room for the RO System and Water Storage Tank.

(For UV Systems) The Ultraviolet Sterilizer requires access to a 110V power outlet; make sure you have safe access to power for this system (not to be shared with garbage disposal - power surge protector highly recommended). **Do not look directly at UV Bulb without protection!**

NOTE! ACCEPTABLE WATER SOURCES Potable community source water or potable private well water that is properly chlorinated to provide proper microbiological protection. For liability reasons RO manufacturers and even UV Disinfection manufacturers will not take responsibility for giving you any microbiological protection, and therefore leave it up to you to be sure the water is first properly disinfected with chlorine. Performance will vary based on local water conditions.

Incoming Water - Incoming water pressure must be between 45 PSI and 80 PSI. If your water pressure is under 45 PSI you will need a booster pump for your system. If your water pressure is above 80 PSI you will need a pressure regulator for your system. Test your water pressure occasionally to make sure the system is performing.

Leaks - The Leak Stop Valve must be installed. Inspect all connections after the installation to make sure no leaks occur, wait until after the system is pressurized (turned on) to inspect again. Check system occasionally after installation or maintenance to make sure no leaks have developed. Install the system in a location with adequate drainage.

General - This RO System unit is for climate controlled indoor use only. Exposure to overly high or low temperature ranges will damage the unit. Follow all of your state and local laws and codes regarding plumbing even if they differ from

what is stated in this manual. If your state law requires it or you prefer to we recommend using a professional licensed installer or plumber who meets the requirements of this system. All O-Rings, fittings, filter cartridges, filter canisters, and Teflon tape wear out after a certain period of time. The lifetime of your components are subject to change with the quality of the water supplied. Do not handle an unwrapped filter directly with your bare hands as this can cause early filter failure. Use appropriate eye and face protection when performing any drilling.

System & tank installation location is recommended to be no more than 10ft away from the RO faucet and any other P.O.U. (ie. fridge) to prevent loss of pressure. Tubing extended more than 10ft away from the RO tank and faucet may not create enough back pressure to shut system off.

Maintenance - The owner / user is obligated to properly maintain the RO System when necessary, at least every 1 year. This includes the following:

- Replace the O-rings on the filter housings, membrane housing, fittings, and filter cartridges.
- Replace any connectors and filter housings with proper replacement parts.
- Maintain & check tank pressure at 7-10 PSI on an empty tank.
- Sanitize your system as often as needed (how often changes with the profile of your area's incoming water).
- Always use proper replacement filter cartridges with the correct size and length replacements.
- Replace the Teflon Tape on all threaded connections and fittings.

NOTE! If your water is microbiologically unsafe or of unknown quality do not use this system without adequate disinfection before or after the system. Extremely hot or cold incoming water will damage the system and cannot be used.

Copyright © 2022 by Express Water Inc. All rights reserved. No part of this publication may be reproduced, distributed, or transmitted in any form or by any means, including photocopying, recording, or other electronic or mechanical methods, without the prior written permission of the publisher, except in the case of brief quotations embodied in critical reviews and certain other noncommercial uses permitted by copyright law.



INSTALLATION NOTES & COMPONENTS LIST

Your new Reverse Osmosis Water System should include the following items. If any item is missing please contact Express Water. Please take a few moments to check all the following components:

Tools Required - Before you begin please make sure you have all of the following tools ready to use:

- 1/4" Drill Bit (for Drain Saddle Valve)
- Power Drill
- 1/2" Drill Bit (for RO Faucet)
- Tube Cutter
- Phillips-Head Screwdriver
- Teflon Tape
- Adjustable Wrench
- Box Cutter

Color Coded Tube 1/4" OD

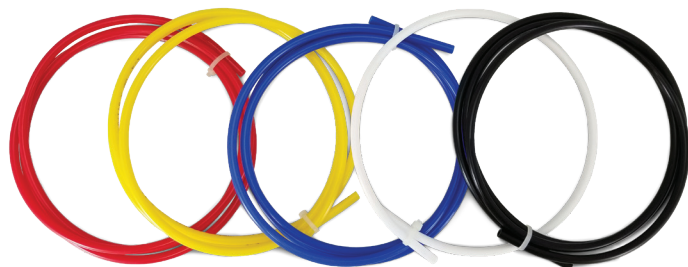

5 ft Red 5 ft Yellow 5 ft Blue 2 ft White 5 ft Black

Drain Saddle Package



2 Bolts

2 Drain Clamp Halves

2 Nuts
Foam Gasket

Connections



Faucet Adapter
1/4" QC x 7/16" FNPT

Male Elbow
1/4" QC x 1/4" THD

Male Elbow & Red Plug

Tank Valve
1/4" QC x 1/4" FNPT

1/4" Locking
Clip Bag

2
Screws

1/4" QC
Feed Water
Adapter Valve
3/8" x 1/2"

Teflon
Tape

3 1/2"
Housing
Wrench

3"
Membrane
Wrench

Leak Stop Valve



3 Replacement
Pads (3/4")

2 Mounting
Screws

1/4" QC 1/4" QC

Pressurized RO Storage Tank

Water Storage Tank
Tank Stand



1/4" Thread

Pressurized
Storage Tank

Preset at 7-10
PSI (on an
empty tank)

Air Valve

Tank Stand

NOTE! In the package you will find the Tank Stand screwed to the top of the tank. Unscrew it and place it underneath for a steady position.

RO Faucet Kit

See pages 10-11



(Faucet design may vary)



SYSTEM COMPONENTS

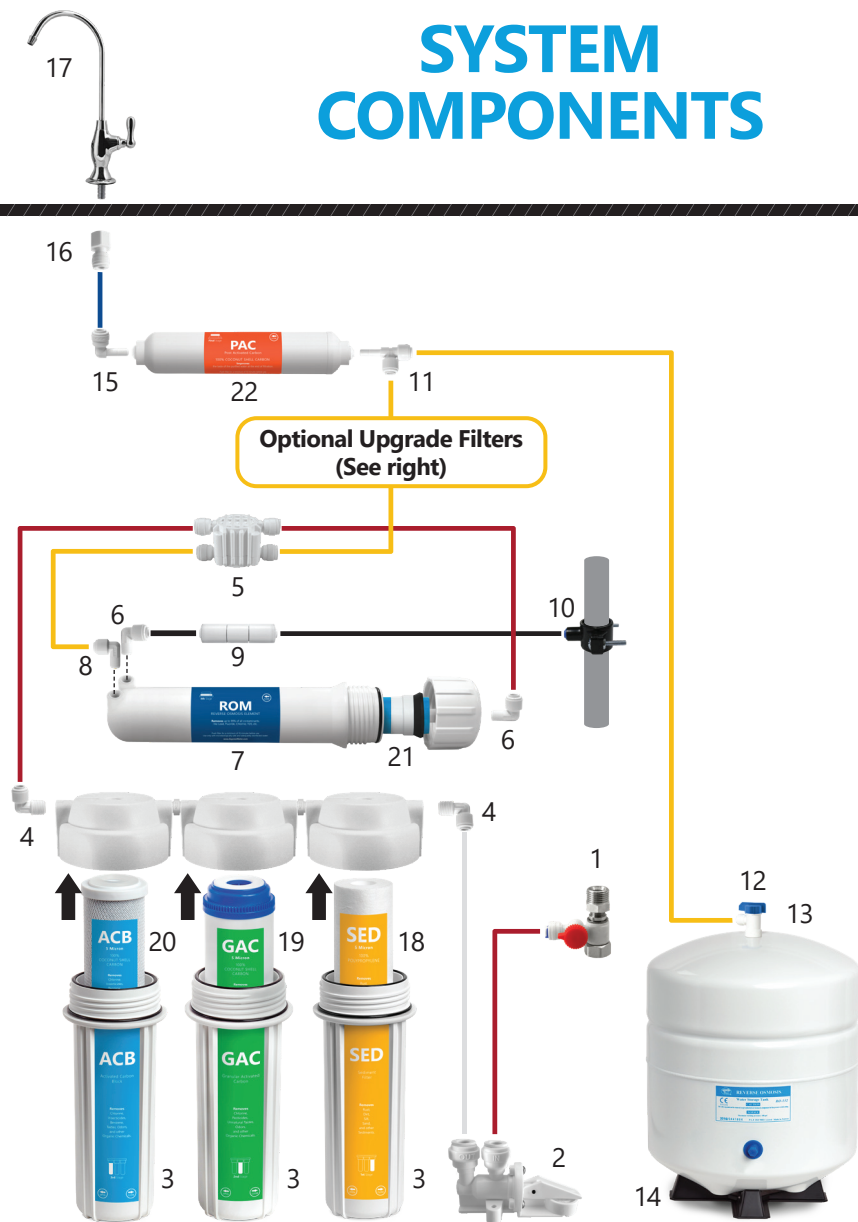

- | | |
|---|---|
| 1. Feed Water Adapter Valve <i>PRTFAV3812</i> | 14. Tank Stand |
| 2. Leak Stop Valve <i>PRTLKS14Q</i> | 15. Stem Elbow <i>PRTFITSE14Q</i> |
| 3. Filter Housing <i>PRTHSF10DB14</i> | 16. QC Faucet Connector <i>PRTFA14Q</i> |
| 4. Male Elbow 1/4" <i>PRTFITME14M14Q</i> | 17. RO Faucet <i>See pages 10-11</i> |
| 5. Automatic Shut-Off Valve <i>PRTASV14Q</i> | 18. SED Filter <i>FLTSED0501</i> |
| 6. Male Elbow 1/8" <i>PRTFITME14M18Q</i> | 19. GAC Filter <i>FLTGAC0501</i> |
| 7. RO Membrane Housing <i>PRTFLTMHQ18</i> | 20. ACB Filter <i>FLTCAR0501</i> |
| 8. Check Valve 1/8" <i>PRTFITCV1418Q</i> | 21. RO Membrane
50 GPD <i>FLTMEME50</i>
100 GPD <i>FLTMEME100</i> |
| 9. Drain Flow Restrictor
50 GPD <i>PRTFLO30014Q</i>
100 GPD <i>PRTFLO60014Q</i> | 22. Inline PAC Filter <i>FLTIN01PKQ</i> |
| 10. Drain Saddle <i>PRTDS14Q</i> | 23. ION Filter <i>FLTDI10J</i> |
| 11. Stem Run Tee <i>PRTFITSRT14Q14Q</i> | 24. ALK Filter <i>FLTALK10Q</i> |
| 12. Tank Valve <i>PRTVT14F38Q</i> | 25. UVS Housing <i>FLTUV110BCH</i> |
| 13. Water Storage Tank <i>RO132-TNK</i> | 26. UVS Bulb <i>FLTUV110B1PK</i> |

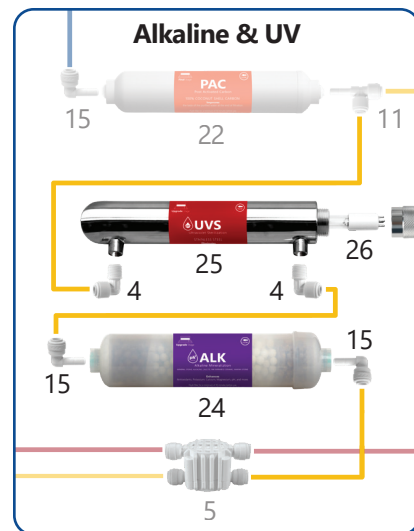
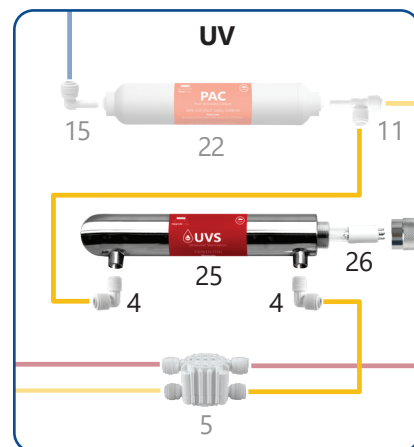
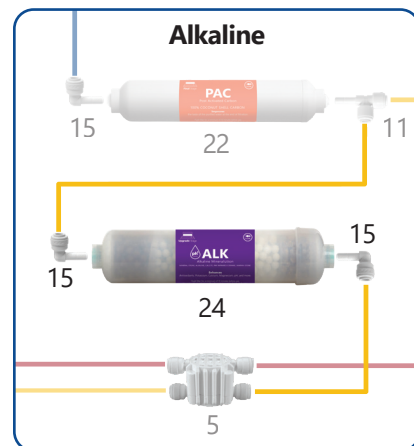
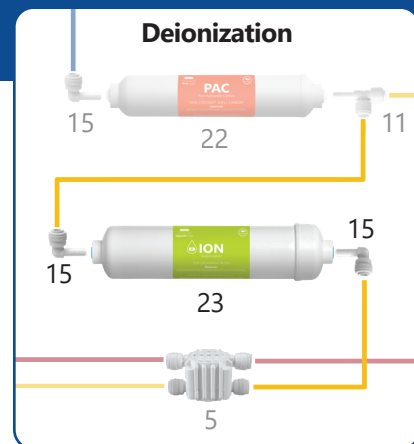

TUBING QUICK CONNECT GUIDE

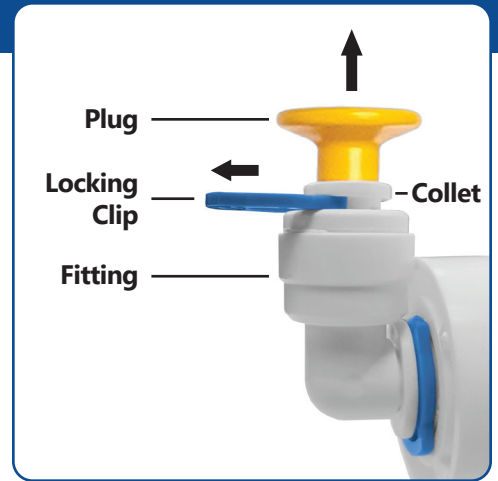

NOTE! Make sure to remove any plugs before attempting to insert tubing.

The tubing in your RO System uses a Quick Connect locking mechanism to lock the Color Coded Tubing in place. Be careful not to damage your tubing as you unpack it.

Release Tubing / Plugs / Fittings

If there is a Locking Clip on the Collet it must be removed before the Tubing can be released. Push and hold the Collet in to release the lock while pulling out on the Tube / Plugs / Fittings.

NOTE! Collet must be held down while pulling up on the tube to release it.

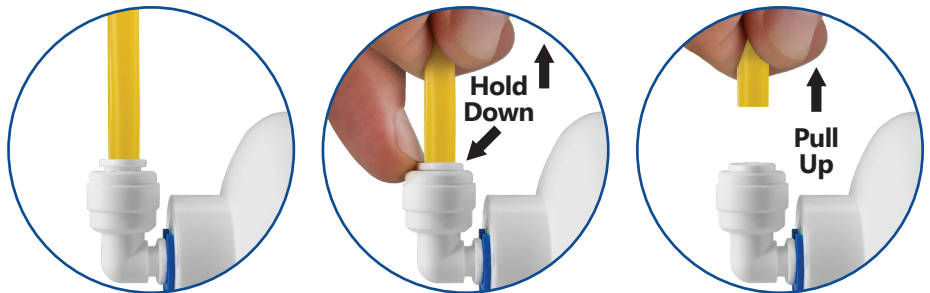

Insert or Remove Locking Clips

To lock a Tube in place make sure the Tubing is fully inserted then slide the open end of the Clip between the Collet and Fitting. The Clip must be removed before the Tubing can be removed. To remove the Clip pull away until it slides out from between the Collet and Fitting.

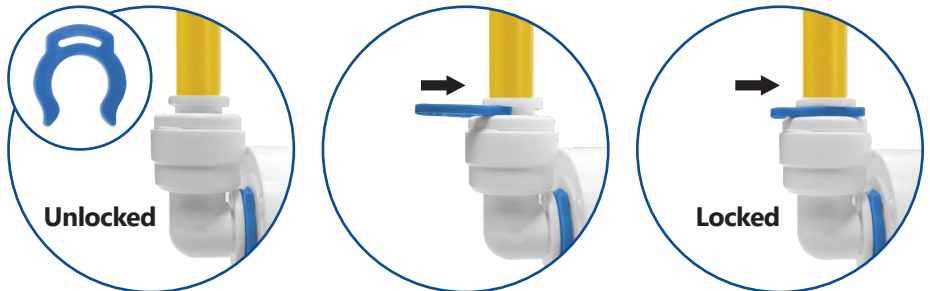

Attach Tubing

Push Tubing in straight and level with the Collet. The Tubing will go 5/8" into the Collet before the lock is activated. Pull out on the Tube to make sure the lock has activated and the Tubing is secure.

NOTE! Once connected, make sure to check tubing is secure.

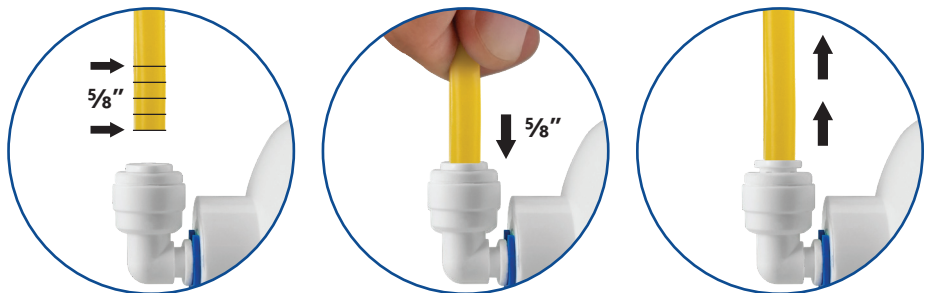

To Cut Tubing

Make your cuts against a flat cutting surface with a razor blade, or use a handheld tube cutter. Any cuts to your Tubing must be perfectly straight.

NOTE! Improperly cut Tubing may leak water or fail to lock into Fittings.

Wait until all elements of your RO System are in their final locations before cutting your Tubing. Make sure you measure the length you will need before cutting in order to avoid unnecessarily lengthy tubing.



FEED WATER ADAPTER VALVE

CAUTION! The water supply to the unit **MUST** be from the **COLD WATER LINE**. Using **HOT WATER** will severely damage your RO System.

NOTE! If your Cold Water Valve is too old or weak to connect to directly Option **A** you can connect at the top of the line where the faucet connects Option **B** (if applicable, some sinks do not have this connection point).

1. Locate the Cold Water Valve underneath the sink and turn it off completely. Next, open the cold water handle on your sink to release any pressure by expelling any existing water. Check to make sure the water has stopped flowing completely before proceeding.

Do Not Connect To Hot Water Line!

NOTE! On single-handle faucets the hot water may have to be turned off to prevent hot water crossover (only during your first installation).

If water still continues to come out of the faucet with the Cold Water Valve turned off, then the main water supply must be turned off as well.

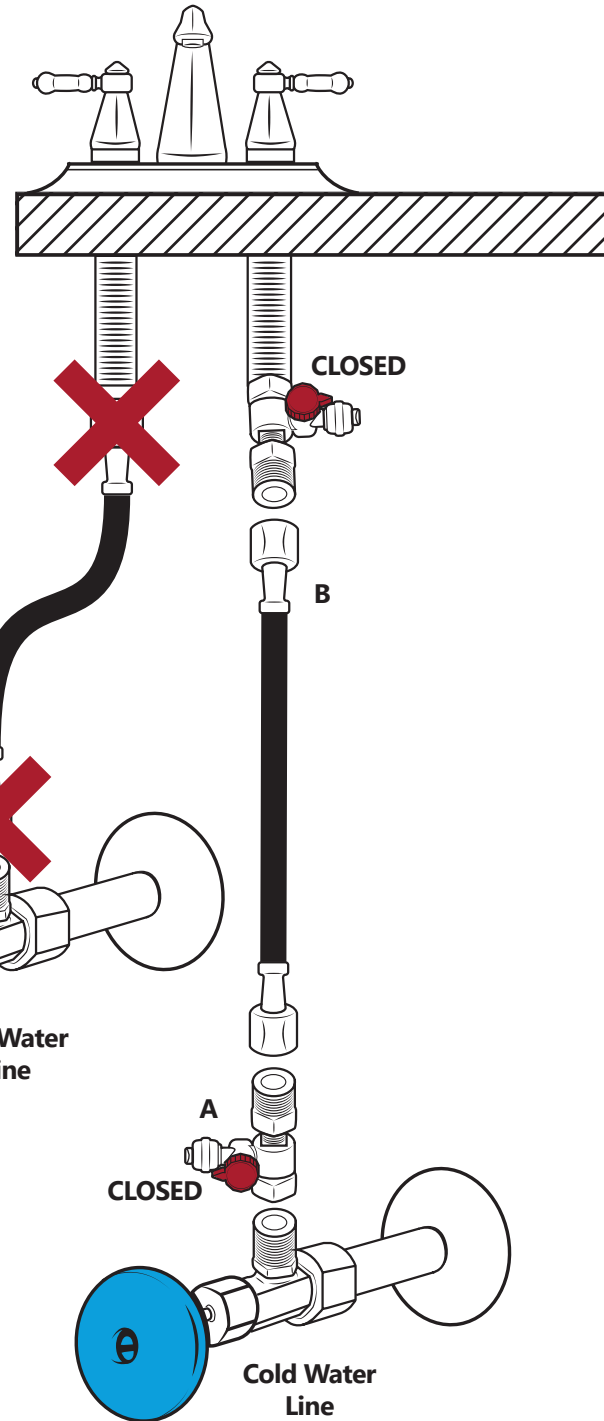

2. As shown below, the Feed Water Adapter Valve can be used for $\frac{3}{8}$ " or $\frac{1}{2}$ " feed line plumbing.

Simply switch the Adapter Nut (see left image) from one side of the Adapter Valve to the other.

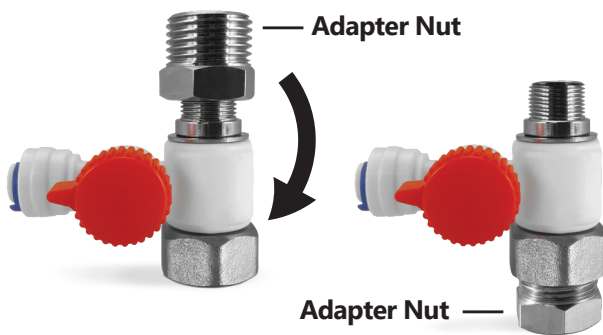

$\frac{1}{2}$ " Connection

$\frac{3}{8}$ " Connection

Next, use an adjustable wrench to secure the Adapter Valve either directly to the Cold Water Valve Option **A** or further up in the line before the faucet Option **B** (if applicable). Make sure your Adapter Valve is in the closed position when installing it.

NOTE! Do Not Use Teflon Tape! Use your wrench to tighten the connection, be careful not to over tighten.

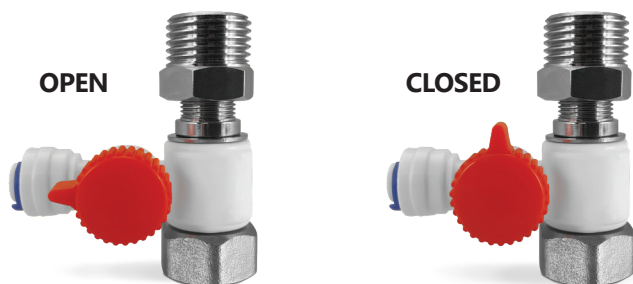

OPEN

CLOSED

WARNING! INCOMING WATER PRESSURE SHOULD NOT EXCEED 80 PSI

Using the Feed Water Adapter Valve

During installation leave your Feed Water Adapter Valve in the "CLOSED" position until System Startup. The Feed Water Adapter Valve controls all water coming into your RO System. If for any reason you need to stop incoming water turn the Feed Water Adapter Valve to the "CLOSED" position. Always turn this valve off before replacing filters, if a leak is discovered, or when shutting down the system.

RO FAUCET



The RO Faucet may be installed on any flat surface. Check the underside of your install location for interference by making sure that drilling a hole will not damage any pipes or wiring underneath the counter top or sink. Check to be sure there is enough room for the Threaded Faucet Stem.

NOTE! For drilling you must use an appropriate drill bit and drilling method for the material of your sink and counter top. Different drill bits are required for stainless steel, porcelain, granite, etc.

You may use an existing hole in your counter or sink or drill a new hole (if using an existing hole begin at Step 2). Make sure the Base Plate is big enough to cover the hole you use.

Porcelain Sink

A proper porcelain $\frac{1}{2}$ " drill bit is strongly recommended to prevent chipping if you are drilling on a porcelain sink. Drill slowly to avoid chipping during the initial cutting of the porcelain.

Stainless Steel Sink

1. Use a proper $\frac{1}{2}$ " drill bit (depending on your sink/counter material) to make a hole for your RO Faucet.
2. Insert the small rubber washer, then the base plate, then the large rubber washer (see image on next page) onto the Threaded Faucet Stem at the base of the RO Faucet. Then put the Threaded Faucet Stem through the newly drilled or preexisting hole. Make sure the RO Faucet sits in the center of your new or existing hole.
3. Under the sink install Plastic Washer, Lock Washer, and Hex Nut (see image on next page) onto the Threaded Faucet Stem. Make sure they are installed all the way up the stem.

4. Faucet Connection Line See connection type A or B

NOTE! You can use either connection type (A or B) - **NOT BOTH.**

Closed



Open



COMPONENTS



(Deluxe Only)
Rubber Washer
(Small)

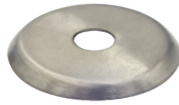

(Deluxe Only)
Base Plate



(Deluxe Only)
Rubber Washer
(Large)

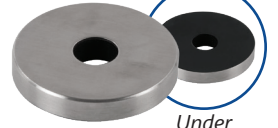

(Modern Only)
Base Plate & Rubber
Washer (Pre-Assembled)

Under

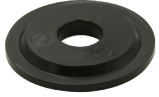

Plastic Washer



Lock Washer



Hex Nut



Insert



Sleeve



Compression Nut

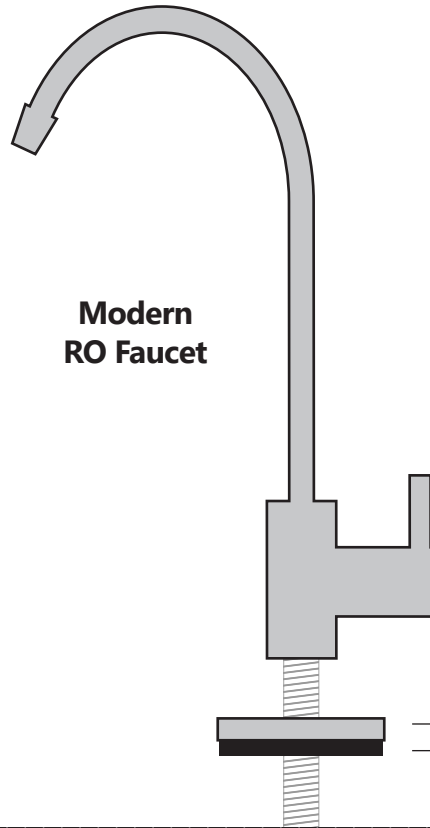
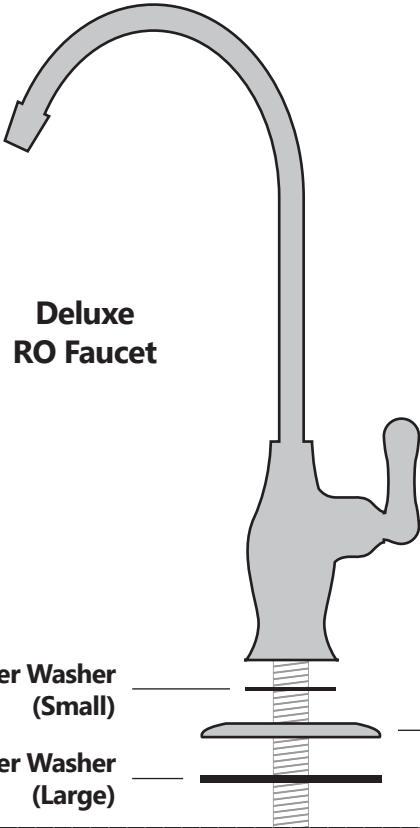

COUNTER TOP

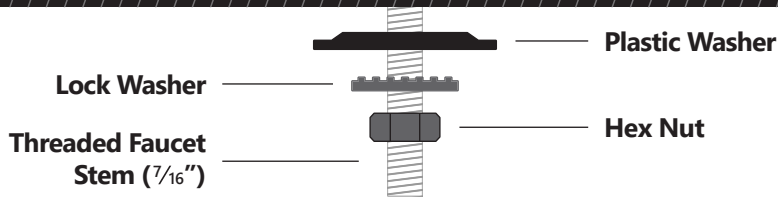

Connection Type A

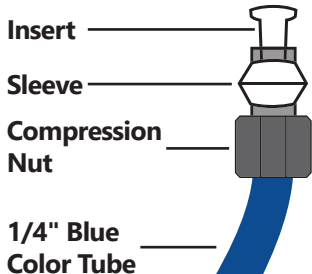

Add the Compression Nut, with the more open end facing outwards, and Sleeve to the Blue Tubing near one of the ends. Add the Insert into the opening at the same end of the Tubing, then bring this end to the Threaded Faucet Stem. Screw the Compression Nut onto the Threaded Faucet Stem with an adjustable wrench. Be careful not to over tighten.

Connection Type B

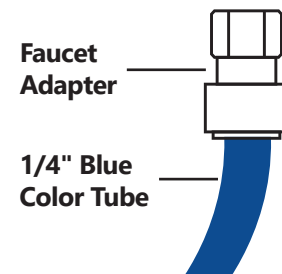

Add the Faucet Adapter to one end of the Blue Tubing. Screw the Faucet Adapter onto the Threaded Faucet Stem.

DRAIN SADDLE

The Drain Saddle is used to connect the Black Drain Line to the drain pipe under the sink, to allow the system to flush contaminants down the drain.

The Drain Saddle is designed to fit around a standard 1½" OD (outer diameter) drain pipe. The Drain Saddle should always be installed above (before) the P-Trap and on a straight vertical or horizontal section of pipe.

To avoid clogging the drain line with debris do not install the Drain Saddle after the drain pipe meets a garbage disposal or dishwasher drain. Refer to the image below to see ideal Drain Saddle locations.

Please contact us if you need help locating a drain saddle placement.

1. Once you have found where your Drain Saddle will go on the Drain Pipe make a mark for the opening there with a marker or pencil.

2. Use your drill and an appropriate ¼" (6.35mm) drill bit to drill a hole at your mark. Be careful to drill through one side of the pipe and stabilize your pipes while drilling to avoid damaging them.

3. Find the half of the Drain Clamp with a hole in its center. Then remove the backing from

the Foam Gasket (the foam circle at the center of the Gasket is disposable). Make sure to align the Foam Gasket hole with the Drain Clamp hole and stick the adhesive side of the Gasket to the inner wall of the Drain Clamp half.

4. Take the half of the Drain Clamp without the Foam Gasket and insert a nut into the recess on each side.

5. Position both halves of the Drain Clamp on the drain pipe with the clamp's opening aligned over the drilled hole. The Foam Gasket will be between the drain clamp and the drilled hole. Push your ¼" drill bit through both holes (the Drain Clamp hole and the hole in the Drain Pipe) and remove to verify that the clamp is properly aligned with the hole you drilled.

6. Secure the Drain Clamp halves together in place on the Drain Pipe. Screw the bolts through the Drain Clamp half with the Foam Gasket and into the half you installed the nuts into (Do not over tighten. Make sure there is equal space on both sides between the Drain Clamp halves).

NOTE! Please make sure drain line is free flowing, and flow is not restricted in any way.

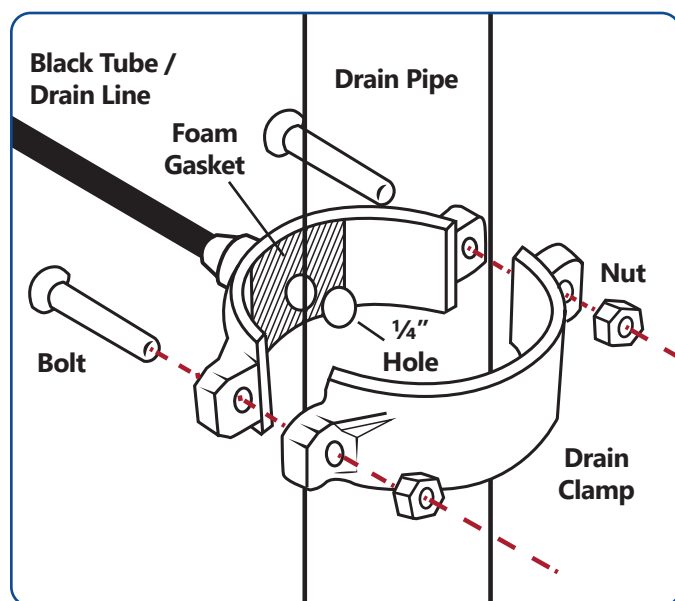
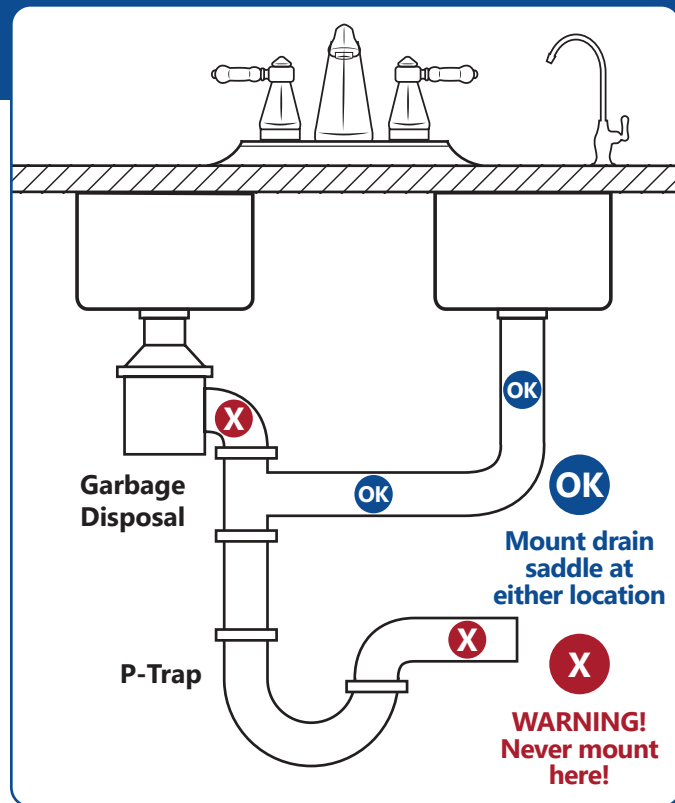

AUTOMATIC SHUTOFF VALVE

Also known as the brain of the system, the Automatic Shutoff Valve reads the back pressure from the RO Tank once it's full, and shuts the system off automatically to stop draining. As the RO Tank water storage depletes, the Automatic Shutoff Valve will open and initiate the system to start purifying the water, ensuring that you have RO water readily available.

The Automatic Shutoff Valve activates when back pressure builds up in the product line due to a full, pressurized bladder tank. To conserve water, the back pressure from the full tank will be detected by the Automatic Shutoff Valve and shut off the incoming water to the RO Membrane.

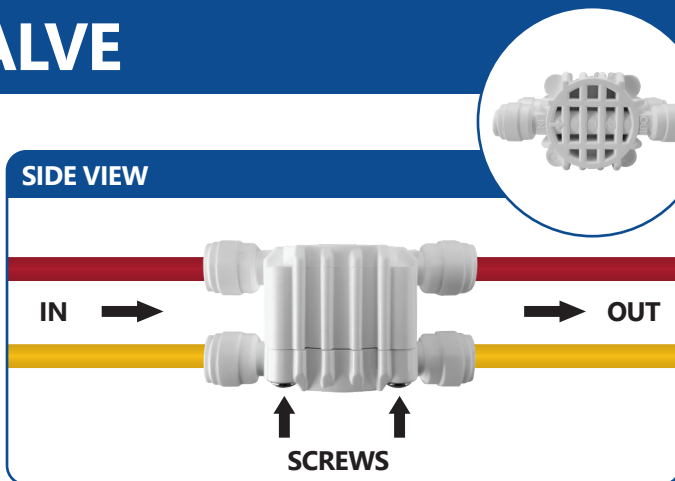

HOUSING ASSEMBLY

Prepare Prefilters

Leave the filters wrapped until you need them. When installing be careful not to touch the filter portion with your hands.

Remove the plastic wrap from the 3 Filter Housings and stand them upright. Make sure each Housing has two O-Rings firmly in place at the top of the Housing and in the Housing's lower groove.

Food grade lubricant pre-applied on O-rings. Please do not wipe off to prevent over-tightening.

NOTE! Reference image to place each of the prefilters in the correct order:

- The yellow SED Filter will be on the far right (under the label "TO FEED").
- The blue ACB Filter will be on the opposite side, the far left.
- The green GAC Filter will be in the center. The white washer will be facing up for correct placement.



⚠ ATTENTION

1. The RO Membrane is already inside the ROM Housings on the system. To make sure the cap is secure, tighten the RO Membrane Housing Cap clockwise by hand, then use Wrench to reinforce seal.
2. Use your hands to screw each Filter Housing onto the RO System. Finish tightening each housing using the filter wrench. **DO NOT OVER TIGHTEN!**

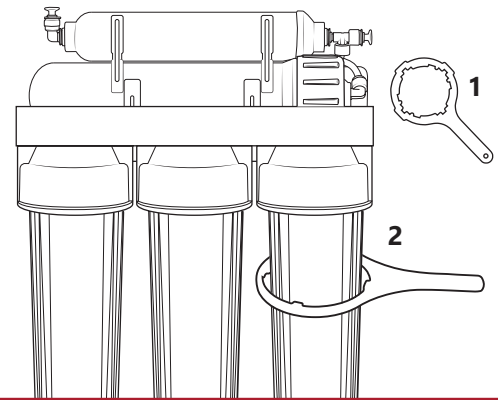

ELBOW FITTING INSTALLATION

NOTE! Teflon is preapplied to Elbows for your convenience. However, if necessary, apply 8-10 rounds of Teflon tape to the Elbows.



1. Screw a Male Elbow Fitting into the rightmost Filter Housing (Sediment) marked "IN". Screw until tightened and the arm of the Elbow is facing downward.



2. Secure the White Tubing into the Male Elbow Fitting. Push hard enough on the tubing to make sure the Quick Connect has locked before moving on.



3. Screw the other Male Elbow Fitting (with red plug) into the leftmost Filter Housing (Carbon Block) marked "OUT". Screw until tightened and the arm of the Elbow is facing upwards at an 11 o'clock angle (use the above image for reference).



4. Remove the Red Plug. Secure the Red Tubing into the Male Elbow Fitting. Push hard enough on the tubing to make sure the Quick Connect has locked before moving on.

GAUGE INSTALLATION

NOTE! Not all RO Systems include a Pressure Gauge. If your system does include a Gauge we will install it now.



1. Put the end of the Pressure Gauge into one of the top arms of the Stem Tee. Then, put the Red Tubing into the opposite end as shown. Both will go about $\frac{5}{8}$ " into the tee to secure.

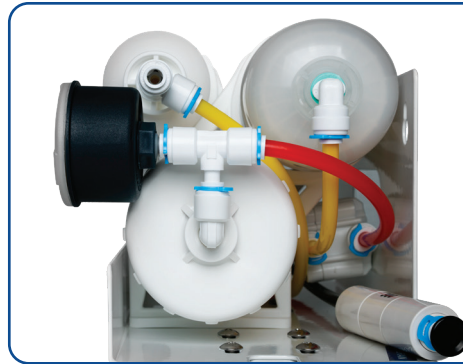

2. Put the small bottom end of the Stem Tee into the Male Elbow of the RO Membrane Cap. Use Blue Locking Clips to secure all 3 connection points as shown.

ULTRAVIOLET STERILIZER*

NOTE! DO NOT TOUCH UV BULB DIRECTLY, USE THE WHITE CERAMIC PORTION TO MOVE THE BULB!

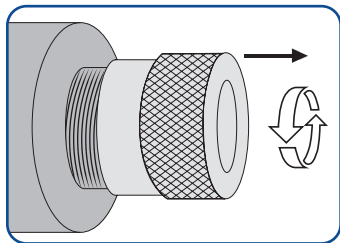
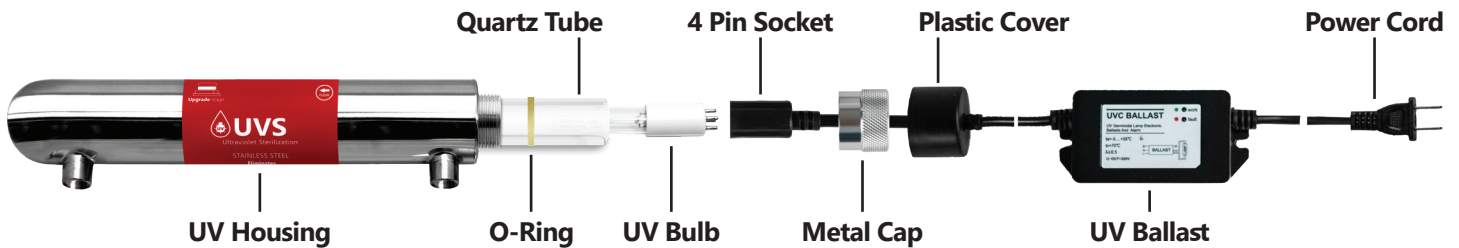

1. Unscrew the Metal Cap counter clockwise from the Ultraviolet Sterilizer Housing.

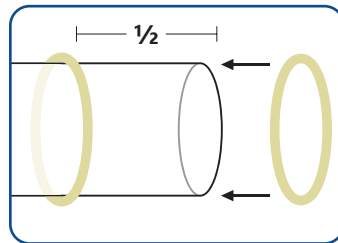

2. Put the O-Ring around the open end of the Quartz Tube (not the bulb) about $\frac{1}{2}$ " away from the end.

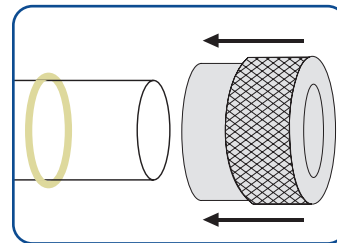

3. Insert the open end of the Quartz Tube into the Metal Cap. The O-Ring will rest against the cap.

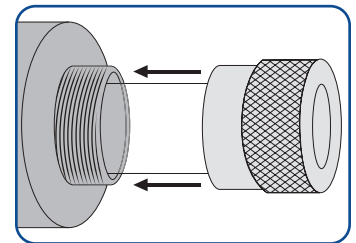

4. Carefully insert the closed end of the Quartz Tube into the UV Housing with the Metal Cap over the end.

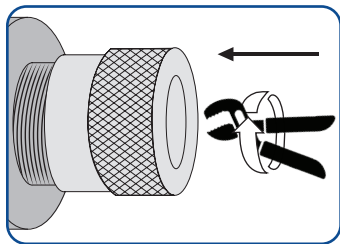

5. Screw the Cap clockwise onto the UV Housing. Use an adjustable plier or adjustable wrench to finish tightening, do not over tighten. Do not use Teflon tape on UV Cap Connection.

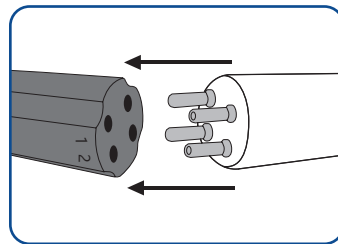

6. Connect the 4 pin electric socket (of the power cord) onto the Ultraviolet Bulb.

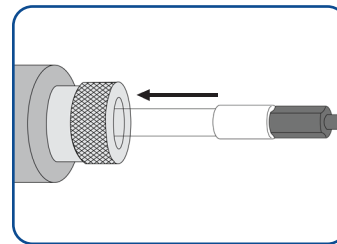

7. Carefully insert the UV Bulb through the opening in the Metal Cap into the Quartz Tube. You will need to remove the housing from its holding clips.

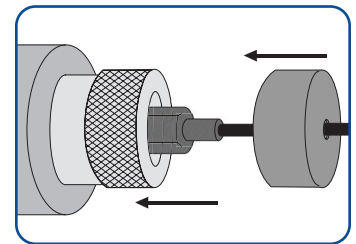

8. Firmly push the Black Plastic Cover (attached to the power cord) in place over the Metal Cap.



LEAK STOP VALVE

Helps detect water leaks if coming from the RO System - if textile pad is activated by a leak, incoming water is shut off, preventing any additional water entering the system.

1. Position the RO System in the desired permanent location.
2. **Position the Leak Stop Valve on the floor of the same cabinet** (so any leaking water will make contact with the valve) beside the system and use the two screws to secure the Valve to the cabinet floor (Valve should be at the same level as the system or below, in order to detect moisture).
3. Connect one end of the Red Tubing into the Feed Water Adapter Valve and connect the other end of the Red Tubing into the hole marked "IN" on the Leak Stop Valve. Then connect one end of the White Tubing into the hole marked "OUT" on the Leak Stop Valve and connect the other end of the White Tubing into the Male Elbow Fitting attached to the Sediment Filter Housing marked "IN".
4. Take the plastic wrap off of the Compressed Textile Pad, then place the Textile Pad inside the Leak Stop Valve as shown (you may wish to insert the Compressed Textile Pad after System Startup is complete in case of early monitored leaks).
5. Turn the Stop Switch down and the Leak Stop Valve is ready.

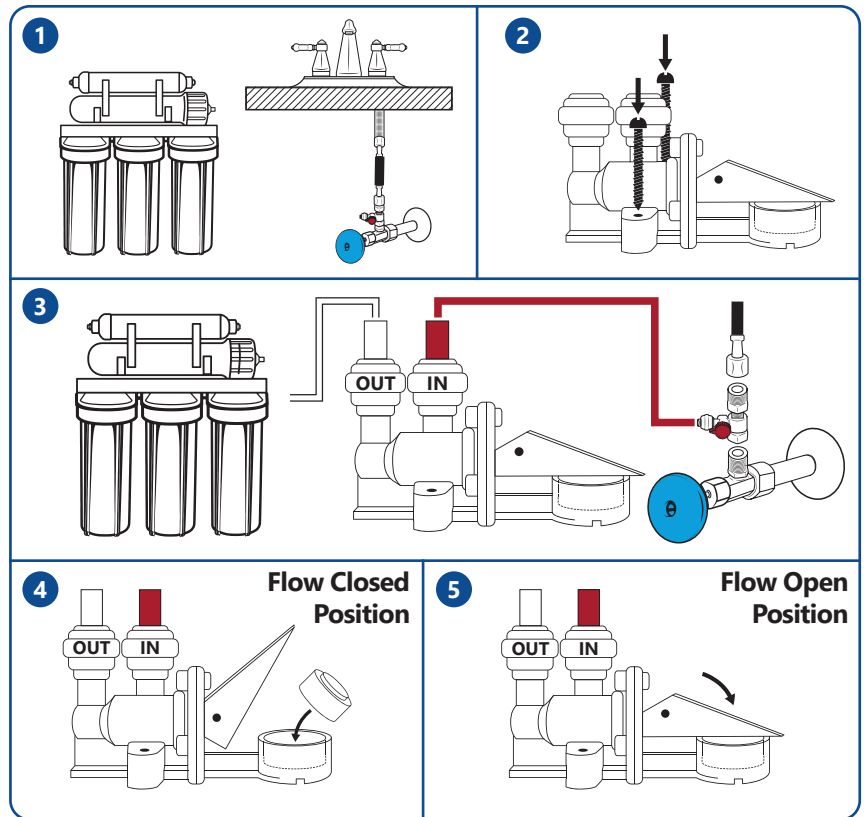

NOTE! Please avoid contact of any liquid to the compressed textile pad. Failure to do so will activate the textile pad and shut the incoming water. Textile pad will not work if plastic wrap is not removed. **Please do not re-use Leak Stop pads once activated.**

WATER STORAGE TANK



NOTE! The Tank Valve only controls water leaving the Water Storage Tank. To stop all incoming water use the Feed Water Adapter Valve.

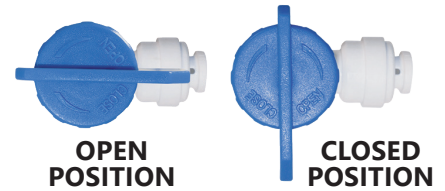

NOTE! Do not tamper with the air valve on the lower side of the Water Storage Tank. It has been preset at 7-10 PSI on an empty tank.

1. Open the Water Storage Tank box and unscrew the Tank Stand from the threaded stem at the top of the Tank.
2. Wrap the threaded stem 8-10 times with Teflon Tape.
3. Screw the Tank Valve onto the threaded stem. Make sure it is tight, but do not over tighten.
4. Place the Water Storage Tank near the RO System in the desired location. The Tank can stand up straight or lie on its side.
5. Connect the Yellow Tubing to the Stem Run Tee of the Inline Post Carbon Filter, then to the Tank Valve (See I to J on Page 16).
6. Keep the Tank Valve in the Closed Position until System Startup.

NOTE! If after 3-5 hours your tank does not fill: Connect the tank directly to the cold water supply (bypassing the RO System) and allow the tank to fill for about 1 minute. Then reconnect to your system as normal and empty the tank through faucet. This will help prime the tank bladder for more water storage capacity.

Tank Bladder Stretching - If your tank does not hold the expected amount of water, connect your water supply to the inlet of the tank valve. Allow tank to fill for one minute. Completely drain the tank then connect your filtration system to the tank. Open your water supply and allow the tank to fill (2-4 hours) then drain tank completely. Your tank is now flushed and ready for normal use.

SYSTEM CONNECTIONS



You may have already completed some or all of these connections in previous steps. Make sure to remove any plugs before installing Tubing. Use the provided Lock Clips to secure any Tubing connections.

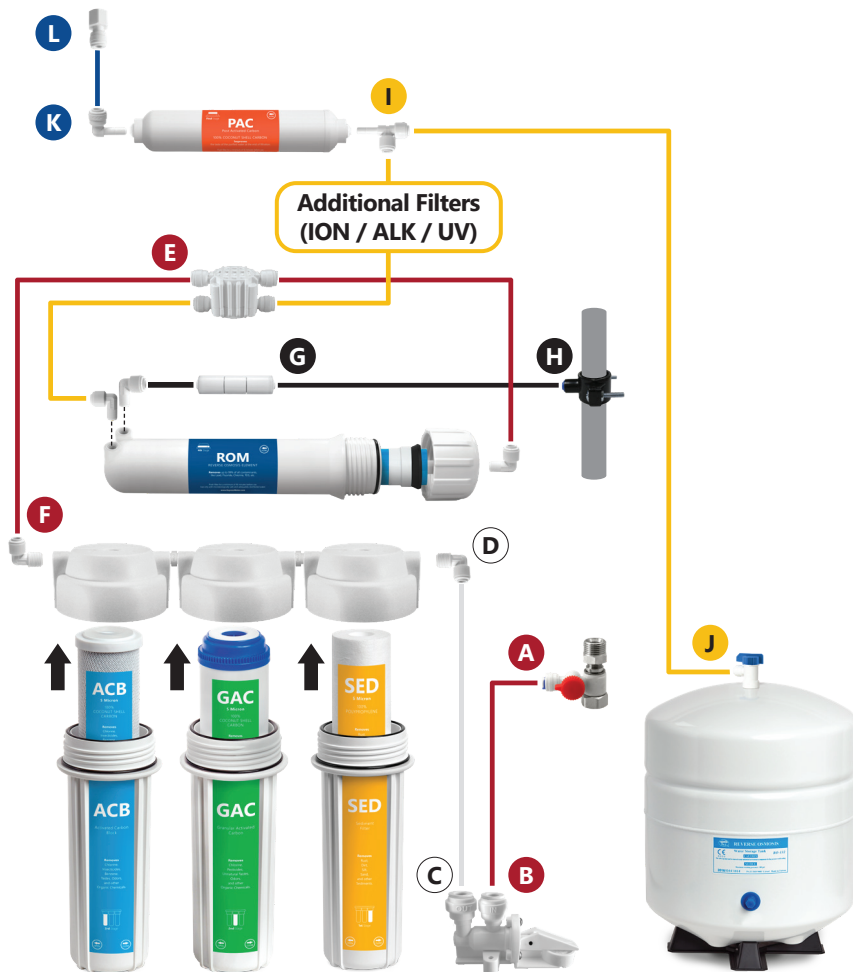

A to B Connect the RED Tubing to the Feed Water Adapter Valve (A), then to the hole marked as "IN" on the Leak Stop Valve (B).

C to D Connect the WHITE Tubing to the hole marked as "OUT" on the Leak Stop Valve (C), then to the Sediment Filter Housing's Male Elbow Fitting (D).

E to F The RED Tubing is already connected to the Automatic Shut-Off Valve (E), connect the loose end to the Carbon Block Filter Housing's Male Elbow Fitting (F).

G to H Connect the BLACK Tubing to the Flow Restrictor side indicated by the arrow on the Restrictor (G), then to the Drain Saddle (H).

I to J Connect the YELLOW Tubing to the In-Line Post Carbon Filter's Stem Run Tee (I), then to the Water Storage Tank's Tank Valve (J).

K to L Connect the BLUE Tubing to the Stem Elbow at the end of the In-Line Post Carbon Filter (K), then to your RO Faucet connection (L).

M (UV Systems only)

Connect the power cord from the UV Sterilizer to an appropriate 110V outlet.



SYSTEM STARTUP

NOTE! Do not send water through your fridge until flushing is complete, carbon particles flushed during startup will clog your refrigerator.

NOTE! Do not drink water from your new system until you have completed System Startup. The flushing process is needed for your filters to begin working.

Time Estimate: 8-12 hours (We recommend running 4 full tanks of water through your new system. Each tank should take 2-3 hours, depending on your home's water pressure levels).

1. Check all connections and ensure they are secure.
2. Turn the Tank Valve to the Closed position (refer to page 15).
3. Open the water supply to the RO System (use Cold Water Supply and Feed Water Adapter Valve refer to page 9) (Make sure the main water supply is also on).
4. Open handle on the RO Faucet (refer to pages 10-11) and wait up to 10 minutes for water to start dripping from faucet. Let the water drip for 30 minutes.
5. Close the handle on the RO Faucet and wait 10 minutes for pressure to build. Then carefully check your RO System for any leaks (Feel or visually inspect every connection point for leaks. If a leak occurs, turn the Feed Water Adapter Valve OFF, refer to page 9).
6. Turn the Tank Valve to the Open position.
7. Allow the Water Storage Tank to fill completely (this takes about 2-3 hours depending on your incoming water pressure).
8. Flush the system by opening the RO Faucet handle until the stored water is completely emptied and the flow is reduced to a trickle (about 3-5 minutes).
9. Close the RO Faucet handle and allow the Tank to fill again.
10. Repeat steps 7-9 two more times (about 4-6 hours). (Occasionally check for leaks during this time)
11. Let the tank fill one final time and sit overnight (8+ hours) before flushing the water
12. After the 5th tank is filled you may drink the water.
13. Check for leaks daily during the 1st week of use and periodically thereafter.

NOTE! You may notice that the water has a milky color during the 1st week. This is an indication of air bubbles in the water. This is normal during this period and the water is safe to drink.

NOTE! You may notice that the water has a milky color during the 1st week. This is an indication of air bubbles in the water. This is normal during this period and the water is safe to drink.

NOTE! You may notice that the water has a milky color during the 1st week. This is an indication of air bubbles in the water. This is normal during this period and the water is safe to drink.



SYSTEM MAINTENANCE

These recommendations are intended for maximum efficiency of your RO System.

Filter and RO Membrane Storage

- Store unopened filters in an airtight container to prevent them from absorbing air. This prolongs the shelf life of the filters and avoids any possible odors or contamination from the air.
- Using this method it is okay to store filters for several years. Store in a cool, dry, dark place (avoid heat and moisture contamination).

Extended System Non-Use (Vacation Mode)

When you plan to not use your RO System for 2 weeks or more it should be Turned Off.

Locate the red Feed Water Adapter Valve connected to your Cold Water Supply (refer to page 9).

Turn Off System: Turn the red Feed Water Adapter Valve to point away from the Red Tubing connection (in the Closed position, page 9) to close the water supply to the system (for UV Systems, unplug the power cord from the power outlet).

Turn On System: Turn the red Feed Water Adapter Valve to point towards the Red Tubing connection (in the Open

position, page 9) to open the water supply to the system (for UV Systems, plug the power cord back into the power outlet). Flush 2-3 tankfuls to reactivate filters.

For Deactivation Of 1 Month Or More:

1. Shut off the incoming water supply and drain entire system of water through the RO faucet.
2. Remove each filter and place vertically on a clean surface until dry.
3. Place each filter individually in a sealed, airtight plastic wrap and place in the refrigerator for the duration (if filter is reusable and less than 3 months old).
4. You may leave the System and Filter Housings disassembled to ensure it stays dry to prevent bacteria growth.
5. You should wash the filter housings before replacing the filters, when you are ready to restart the system. Flush 2-3 tankfuls to reactivate filters.

NOTE! Depending on your area's water, you may not be able to reuse some or all of your filters. Please contact us if you need more information.

HOW TO SANITIZE YOUR RO SYSTEM

Recommended once every 12 months

1. Before you begin you will need a new SED Filter, GAC Filter, ACB Filter, RO Membrane, Inline PAC Filter, and the Filter Housing Wrench (as well as ION, ALK, and UV filters if applicable). We also suggest using a bucket or bin large enough for the system to sit in (the system will release a lot of water when it is disassembled).
2. Close any incoming water (Feed Water Adapter Valve page 9).
3. Open the RO Faucet handle and drain the system completely (wait until water flow stops completely), then close the Faucet handle.
4. Use the Filter Housing Wrench to open the Filter Housings, then remove and dispose of ONLY the following filter cartridges:

Sediment
Filter (SED)

Granular Activated
Carbon Filter (GAC)

Activated Carbon
Block Filter (ACB)

Reverse Osmosis
Membrane (ROM)

NOTE! Leave the Inline PAC filter (and ION filter, ALK filter and UV housing without bulb if applicable) in place! You will replace it after sanitizing the system.

5. Mix 1 gallon of water with 2 tbsp of household bleach. Do not add bleach directly to the filter housing.
6. Fill up the Prefilter Housings (SED, GAC, and ACB Housings) with your mixed solution and close the housings using your Filter Housing Wrench. Leave tank valve open to sanitize tank.
7. Open the incoming water to the system (Feed Water Adapter Valve page 9) and let it run for 10 minutes.
8. Open the RO Faucet handle and let it drain for 10 minutes.
9. Close the RO Faucet handle and wait for 10 minutes then open the Faucet handle again and wait for it to drain completely, until bleach smell is gone. **(If you smell bleach from your RO Faucet repeat steps 7-9)**
10. You are now ready to replace all filters and restart your system. Please refer to pages 18-19 for detailed instructions, ignore any additional sanitation steps therein.



FILTER CHANGE INSTRUCTIONS



NOTE! If you are having less than the normal 0.8 gallons a minute flow from the RO Faucet, it may be due to the Tank Air Pressure or the incoming water pressure being too low. If you have an incoming water pressure of 50-80 PSI, we ask that you check the pressure inside the tank to verify that there is still between 8-10 PSI of air in the tank **WHEN THE TANK IS EMPTY.**

Please lift the RO Tank and let us know if it produced a full tank of water or no water at all. If so, please check the tank pressure. We recommend emptying the water from the Tank. Once empty, please add up to 10 PSI max into the Tank. This should help increase the water pressure coming out of the Tank. Do not add any more than 10 PSI or you will not have any room for water storage as it will be mostly air pressure.

You may check the air inside the tank using the air valve in the bottom of the tank and a regular pressure gauge (as you would with car tires).

This RO System contains Filters that must be replaced at regular intervals to maintain proper performance. Use only authentic Express Water filters.

Prefilters (ACB, GAC, SED)

Change about every **6 months**



1. You will need a clean cloth, dish soap, filter housing wrench and appropriate SED, GAC, & ACB filters.

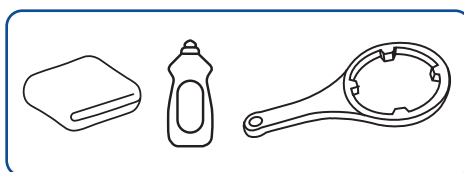

(We also recommend a bucket or bin large enough for the system to sit in - water will be released when it is disassembled.)

2. Turn off the Cold Water Supply connected to the RO System and the Feed Water Adapter Valve (page 9). Then open the RO Faucet handle to release pressure, and empty tank. Close handle when the flow of water stops, then close tank (page 15) (for UV systems, unplug the power cord from the power outlet).

3. Place the RO System in the bucket and unscrew the 3 Prefilter Housings using the Filter Housing Wrench. Remove old filters and dispose of them.

4. Wash the Prefilter Housings with dish soap then proceed to rinse until all soap is removed.

5. Ensure that your hands are washed clean before unwrapping the new filters. After unwrapping, place the new filters inside their correct housings (page 13). Make sure the O-Rings are in their proper locations.

6. Tighten the Prefilter Housings using the Filter Housing Wrench. Do not over tighten.

If these are the only filters you are replacing continue to the Restarting the System section on (page 19).

RO Membrane

Change about every **12 months**



NOTE! Make sure you have **shut down the RO System (Step 2 in Prefilters section).**

MAKE SURE THE CAPACITY (GPD) OF YOUR OLD AND NEW MEMBRANES MATCH.

1. Open the RO Membrane Housing by unscrewing the cap. Pull out the RO Membrane with a pair of pliers. Be sure to note which side is the front and which side is the back.

2. Wash out the RO Membrane Housing. Install the new RO Membrane in the Housing in the correct direction you noted earlier. Make sure to push the Membrane in firmly, then close the Housing by tightening the cap with your hand, and use Wrench to seal securely.

Make sure the O-Ring is in place before you tighten the Membrane Housing Cap.



If this is the only / last filter you are replacing continue to the Restarting the System section (page 19).



Ultraviolet

Change about every 6-12 months

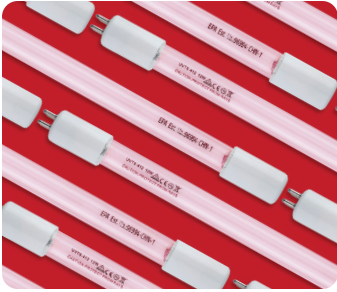

NOTE! Make sure you have shut down the RO System (Step 2 in Prefilters section).

DO NOT TOUCH THE BULB DIRECTLY. HANDLE WITH THE WHITE CERAMIC AREA. DO NOT LOOK DIRECTLY AT THE UV BULB WITHOUT EYE PROTECTION!

MUST HAVE POWER SURGE PROTECTOR.

1. Unplug the power cord from the power outlet.

NOTE! Do Not Unscrew the Metal Cap!

2. Carefully and slowly pull the black plastic cap off the UV Sterilizer (the bulb may come out with the cap, if it does not tilt the system until the white ceramic portion is accessible).

3. Unplug the power cord from the UV Bulb and dispose of old bulb.

4. Connect the new UV Bulb to the power cord.

5. Carefully insert the new UV Bulb into the UV Housing though the opening in the metal cap. Then slowly push the black plastic cap back onto the Sterilizer Metal Cap.

6. Reconnect the power cord to power outlet. If this is the only / last filter you are replacing continue to the Restarting the System section.

Alkaline

Change about every 6 months



NOTE! Make sure you have shut down the RO System (Step 2 in Prefilters section).

1. First disconnect the Stem Elbows from each side of the Alkaline Filter.
2. Note the orientation of the old filter, install the new filter in the same orientation. Remove the old filter from its holding clips and discard it. Remove plugs on new filter. Then, insert the new filter into the holding clips and connect the Stem Elbows to the new Alkaline Filter (check page 7 for layout).

If this is the only / last filter you are replacing continue to the Restarting the System section.

NOTE! Alkaline filters help add beneficial minerals to your water. These elements result in higher TDS.

Deionization

Change about every 6 months



NOTE! Make sure you have shut down the RO System (Step 2 in Prefilters section).

1. First disconnect the Stem Elbows from each side of the Deionization Filter.
2. Note the orientation of the old filter, install the new filter in the same orientation. Remove the old filter from its holding clips and discard it. Remove plugs on new filter. Then, insert the new filter into the holding clips and connect the Stem Elbows to the new Deionization Filter (check page 7 for layout).

If this is the only / last filter you are replacing continue to the Restarting the System section.

Inline PAC

Change about every 12 months



NOTE! Make sure you have shut down the RO System (Step 2 in Prefilters section).

1. First disconnect the Stem Elbow and Stem Tee from the sides of the Inline Post Carbon Filter.
2. Note the orientation of the old filter, install the new filter the same way. Remove the old filter from the holding clips and discard. Next, insert the new filter into the holding clips and connect the Stem Elbow and Stem Tee to the new Inline Post Carbon Filter (check page 7 for layout).

If this is the only / last filter you are replacing, continue to the Restarting the System section.

RESTARTING THE SYSTEM

1. Check all connections, including all filter housings, and ensure they are secure.
2. Fully open the Feed Water Adapter Valve and Cold Water Supply (page 9). Leave tank closed (for UV Systems, make sure the power cord is plugged into power outlet).
3. Open the RO Faucet handle and wait 5-10 minutes for water to start flowing, let water run for 15-30 minutes, then turn the faucet handle off.
4. Open tank, and let the system refill with

water (this takes 2-3 hours). You can open the RO Faucet briefly to release any air trapped inside the system while it's filling (Be sure to check for new leaks during the first 24 hours after restarting).

5. After the Water Storage Tank has filled drain the entire system by opening the RO Faucet until the water flow is reduced to a slow trickle. Then close the Faucet.

6. Repeat steps 4 and 5 three times to fully flush the system (6-9 hours).

NOTE! If the RO System is connected to a refrigerator, do not drain the system through the refrigerator water dispenser. The excess carbon fines from the new carbon filter will clog the internal fridge filter.

Does this system filter Fluoride, Lead, Pharmaceuticals, and Arsenic?

Yes, as well as Cyanide, Phosphate, Pesticides, Sodium, Cadmium, Sulfates, and many other contaminants up to certain levels. Depending on incoming water quality, you may need pretreatment for high levels of certain contaminants.

What PSI do I need? What is the operating pressure?

The minimum PSI for the system is 45 and the maximum PSI is 80. If your PSI is too low you can purchase a Booster Pumps to aid your system. If your PSI is too high you can purchase a Pressure Regulator to reduce your pressure to acceptable levels. Let us walk you through these options.

Does it stop filling automatically when filled? Why is the drain line constantly flowing?

The RO System does stop filling automatically when tank is filled (2-3 hours). If your drain line is constantly flowing this is a sign that your incoming water pressure is too low, or if filters need replacing.

Can I install this system in the basement? If so, will it affect the efficiency of the RO System?

Yes, the RO System can be installed in a basement. However, if you do not have adequate water pressure you may need to purchase a Demand Delivery Pump. Contact Express Water and we'll help you find your solution.

What is the discharge rate?

The typical discharge range is one to three gallons for every one gallon produced. Your water pressure, incoming water quality, and water temperature will affect your RO System's discharge rate.

Why does it take so long to fill up the tank?

The purification process takes some time on its own. However, some water takes longer to process. Your water pressure, incoming water quality, and water temperature will all affect how quickly your RO System fills the Water Storage Tank.

How often do I change Filters? Is there an indicator?

The Sediment, Granular Activated Carbon, Activated Carbon Block, Deionization and Alkaline Filters should be changed every 6 months. The RO Membrane and Inline Post Activated Carbon Filter should be changed every 12 months at the same time as the second change of the 6 month filters. The UV Bulb of the Ultraviolet Sterilizer should be changed every 6-12 months. If the UV bulb needs to be changed early it will alert you with either a red light or beeping noise from the black box (electric ballast on the power cord). There is no direct indicator for filter changes. However, if you notice a drop

in water quality before the 6 or 12 month mark this may mean that due to your water quality you filter has degraded. If you reach 6 or 12 months without noticing a change in taste you should still change your filter at this point, as they are no longer viable.

What is the difference between GAC and ACB carbon filters?

GAC and ACB filters are both made with 100% Organic Coconut Shell Carbon, the only difference is the formation of each filter. ACB Block filters are much more tightly packed, while the GAC is granular loose carbon. The compact nature of the ACB means that even the smallest particles and contaminants cannot pass through the filter and placed as the Post filter on the bottom

Will the Coconut Shell Carbon Filter trigger a coconut allergy?

Depending on the severity of the allergy, the carbon filter may trigger an allergic reaction.

Can I add additional filters to my current system?

Yes, each system is fully upgradeable. Check the Upgrades and Accessories section on page 22 or on our website for more information.

Can I connect this system to a refrigerator or ice maker?

Yes, you may need an Express Water Refrigerator Kit to do so. In some cases, your situation may require a separate tank or Delivery Pump depending on how far away your refrigerator is from the system. Contact Express Water and we'll help you find your solution.

How do I get clear ice?

Lower freezer intensity slightly to allow water to freeze slower and allow trapped air to escape during freezing.

Can I reuse discharge water?

Never consume discharge water. With proper installation it is possible to utilize your discharge water. Contact Express Water to speak with a qualified representative who can give you more information based on your situation.

How long does the system last? How long does the tank last?

With proper maintenance and average water quality an RO System should last 5-10 years. The water storage tank usually lasts 3-5 years before we recommend replacing it.

Can I change my 50 GPD (Gallons Per Day) system to 100 GPD? If so, how?

Yes, to do so, you will need different parts (such as the RO Membrane and Flow Restrictor). Contact Express Water and we will help you arrange your upgrade.

Why are there bubbles in the water?

(NOTE - For Alkaline Systems it is normal to

have more bubbles in your water because of the higher oxygen content.)

Bubbles in your water is a common issue, but they only affect the appearance of your water and pose no risk. There can frequently be air trapped inside any plumbing system, so the air may be coming from your home's plumbing and not the RO System. Trapped air happens frequently when you change a filter, when there is a leak in your system or plumbing, fluctuation in pressure, or even when there is construction in your area. Check your system carefully for any leaks or unexplained moisture. You may need to carefully tilt the system various directions then set it back in place to help release trapped air.

Does this produce aquarium safe water?

RO Deionization System - The Deionized water is safe for appropriate aquatic life. Be sure to test your water regularly to make sure it is safe for your aquarium.

All other systems - We suggest installing our Deionization Filter Upgrade to create water for aquatic life.

Why do I need to flush the system?

The flushing process helps activate filters and open pores for efficient filtration. In addition, new filters (or filters that have experienced extended disuse) can develop carbon residue. We recommend emptying the Water Storage Tank four times (which can take 8-12 hours) to release any extra carbon before the water is safe to drink.

How much water can the standard Water Storage Tank hold?

The maximum capacity of the tank is 3.2 gallons. However, the typical tank reaches 2-2.5 gallons. Your Water Storage Tank's capacity depends on your incoming water pressure. Lower water pressure means the tank will hold less water.

What should I do in a boil water advisory?

As long as all of your filters are working properly you can drink water from your RO system without boiling. You **MUST** replace all of your filters after the order is lifted. While the system will filter large amounts of harmful agents, it can damage your filters and cause bacteria to grow. You should follow sanitization instructions when replacing the filters.

Does this system soften water?

Your RO System will soften water. However, hard water does reduce the lifespan of your Filters.

What if I need to produce more water?

There are a lot of solutions to this problem; it's possible to upgrade your drinking water system with some specialty equipment, or we can help you with other solutions. Just contact us and we can help you find the solution that best fits your home.



TROUBLESHOOTING

NOTE! Turn off the system before servicing or inspecting.

PROBLEM	POSSIBLE REASON	SOLUTIONS
1. Milky colored water 2. Air bubbles in water	Air in system	Air in the system is a normal occurrence with RO System startup. This milky look will disappear during normal use within 1-2 weeks.
3. Noise from system	Air gap in Faucet	Will disappear after system shutdown.
	Location of Drain Saddle	Relocate the Drain Saddle to above P-Trap.
	Restrictions in drain line	Clear possible debris from garbage disposal or dishwasher.
	Air in system	Lift up the system and tilt it in various directions to release the air bubble from the system and out of the faucet.
4. Slow production or no water from RO faucet	System just starting up	Normally it takes 2-3 hours to fill the tank. Low water pressure and/or temperature can reduce production rate.
	Low air pressure in Water Tank	Add pressure to the storage tank. The pressure should be 7-10 PSI when the tank is empty.
	Low (<45PSI) incoming water pressure	Add a booster pump before RO Membrane.
	Crimps in tubing	Make sure tubing is straight.
	Clogged Pre Filters	Replace Pre Filters.
	Fouled RO Membrane Restricted drain line	Replace RO Membrane. Readjust black tubing to ensure drain flow is unrestricted.
5. Water taste or an offensive smell	PAC Filter Depleted	Replace PAC Filter.
	RO Membrane depleted or fouled	Replace RO Membrane.
	Sanitizer not flushed out	Flush System and Tank until sanitizer smell is gone.
	Alkaline System needs more flushing	Flush 1-2 more tankfuls to remove excess minerals.
	Bitter taste caused by Carbon fines displaced inside RO Tank during startup	Flush RO Tank upside down to release settled Carbon Particles. Flush as needed.
	Tubing mistakenly switched on ROM Housing for clean and drain water	Check ROM Filter Housing connections on page 16.
	Fishy taste from ALK Filter Fishy taste from Di Filter	Flush System 1-2 more times - flush ALK Filter excess minerals. Di Filter is depleted and requires replacement.
6. No drain water	Clogged Flow Restrictor	Replace the Flow Restrictor.
	Membrane improperly installed	Push membrane filter firmly & securely into ROM housing.
	Clogged Prefilter	Replace Prefilters.
7. Leaks	Fittings are not tightened	Tighten fittings as necessary.
	Twisted O-Ring / Nicks & Scratches	Replace or readjust the O-Ring.
	Hole misalignment in Drain Saddle	Realign Drain Saddle.
	Threaded Connections	Replace Teflon Tape with 8-11 rounds.
	Tubing not pushed entirely into fitting Defective tubing	Push tubing into fitting past o-ring seal. Cut damaged area from tubing or replace tubing.
8. No water	Check Leak Stop Valve	Refer to page 15.
	Check Feed Water Adapter Valve	Refer to page 9.
	Restricted Drain Tube	Clear restriction.
	Air trapped in Tank Valve tubing.	Close Tank & Feed Valve. Disconnect tubing from Tank Valve and hold over bucket, turn on Feed Valve until water starts flowing from tubing. Reconnect tubing to Tank Valve.
	Too much air pressure in RO Tank New RO Tank bladder needs stretching	Reset air pressure between 7-10PSI on an empty RO Tank. Check page 15 for Tank bladder stretching.
9. Continuous draining of water	Low (<45PSI) incoming water pressure	Add a booster pump before RO Membrane.
	Water quality issues	System pretreatment may be required.
	Defective Automatic Shutoff Valve	Replace automatic shutoff valve.
	Distance from RO Tank, System and Faucet exceeds 10ft	Add a second RO Tank closer to the Faucet or other POU (point of use).
	Unnecessary extra tubing length Demand of water production from POU (i.e. refrigerator/icemaker/etc.)	Cut tubing length accordingly with no looping. Draining required to supply demand.
10. Faulty UV Ballast (if applicable)	Electrical plug short circuit	Check 2-3 more electrical plugs in different locations.
	Shares plug with Garbage disposal	Install extension cord under sink with power surge protector
	UV Bulb burn out	Replace UV Bulb.



UPGRADES & ACCESSORIES

Add additional stages or features to your RO System.
Visit expresswater.com for more information.



Water Chiller

PC2000

The easy to install compact Power Chiller allows you to have cold refreshing water on demand from your RO Faucet.



Pressure Regulator

PRTPR80Q

If your water pressure is too high for the RO System, the Pressure Regulator will reduce your incoming pressure.



Pressure Gauge

PRTG1402

A Quick Connect optimized 160 PSI Pressure Gauge for monitoring incoming water pressure from your RO System.

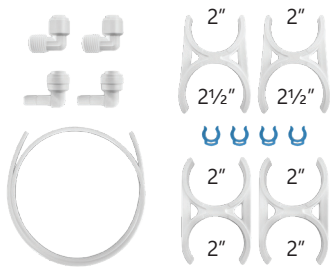

Upgrade Kit

PRTUPKIT14

All connections necessary to upgrade your system - purchase together with an ION or ALK filter.



Deionization Filter *FLTDI10J*

Deionization removes Total Dissolved Solids (TDS) from your water via ion exchange, giving you purer drinking water.



Alkaline Filter *FLTALKQ10*

Adds a five-layer Alkaline mineralization stage to your RO System. This filter produces more PH Positive water with antioxidants and up to 20% more oxygen.



Ultraviolet Sterilizer *FLTUV110BCH*

Adds a UV light (110V) sterilization stage to your RO System. This effectively eliminates up to 99.99% of microorganisms, cysts, viruses, and harmful bacteria like E. coli, fungi, etc. (includes installation connections).



Refrigerator Kit

PRTREFKIT14Q

Extra tubing and connections to supply your refrigerator with RO purified water.



Water Storage Tanks

RO-132, GTS2 - GTS40

100% food grade water storage tanks in sizes from 2 to 40 gallons.



Whole House Systems

WH300SCGS / SCKS / SCPS

The best in Whole Home filtration. Visit www.expresswater.com for more information.





1 YEAR LIMITED WARRANTY

As manufacturer, we do not know the characteristics of your water supply or the purpose for which you are purchasing a drinking water system. Please understand that the quality of water supplies may vary seasonally or over a period of time, and that your water usage rate may vary as well. Water characteristics can also change considerably if your drinking water system is moved to a new location. For these reasons, we assume no liability for the determination of the proper equipment necessary to meet your requirements, and we do not authorize others to assume such obligations for us.

Further, we assume no liability and extend no warranties, express or implied, for the use of this product on a non-potable water source. OUR OBLIGATIONS UNDER THIS WARRANTY ARE LIMITED TO THE REPLACEMENT OF THE FAILED PARTS OF THE DRINKING WATER SYSTEM, AND WE ASSUME NO LIABILITY WHATSOEVER FOR DIRECT, INCIDENTAL, CONSEQUENTIAL, SPECIAL, GENERAL, OR OTHER DAMAGES, WHETHER FROM CORROSION OR OTHER CAUSES.

We Cover

This warranty covers any defects in the parts or manufacturing of your Express Water Reverse Osmosis Water System. We will give you new replacement parts in exchange for any defective parts.

What to Do

Give us a call at 1-800-992-8876 or send an email to support@expresswater.com and describe the problem to our support. Be sure to have a copy of your purchase confirmation email or receipt. Our support will verify that the product and problem are under warranty and help you arrange to send your defective part back to Express Water with your receipt and contact information (name, address, phone number, email address). Support will help arrange sending of the defective part, the delivery of your replacement part, as well as guiding you through the installation.

Time Covered

This warranty is effective for 1 full year from the date of original purchase.

Not Covered

This warranty does not cover labor for removal or installation, accumulation of dirt or grime (you are responsible for your own cleaning), systems with the serial number removed or altered, damage from improper storage (high or low temperature, sun damage, etc), damage from a system not installed as instructions directed, anyone other than original purchaser, damage from system abuse or unintended operation of system, accident, fire, flood, freezing, or any acts of God, improper water source, modification, negligence, commercial use of the system, Filters, RO Membrane, incidental damages from system failure, systems used with parts not provided by Express Water (including tanks, filters, faucets, pumps, diverter valves), or cosmetic damages.

Your State

Some states have further regulation on damages and warranty coverage.
You may have other rights depending on your state.

For warranty questions, service, or help give us a call: **Monday - Friday 10 am to 5 pm PST: 1-800-992-8876**









support@expresswater.com • www.expresswater.com

Express Water Inc. 12730 Raymer St, Unit 1, North Hollywood, CA 91605



Replacement Filters: Express Water offers replacement filters for both 50 GPD and 100 GPD RO Systems. For purchasing information, please visit us at www.expresswater.com.

INSTALLATION DATE:

Filters	SED Filter	GAC Filter	ACB Filter	RO Membrane	Inline PAC Filter	ION Filter	ALK Filter	UV Filter
								
Model	FLTSED0501	FLTGAC0501	FLTCAR0501C	FLTMEME50 (50 GPD) FLTMEME100 (100 GPD)	FLTIN01PKQ	FLTDI10J	FLTALK10Q	FLTUV110BCH
Service Life*	6 Months	6 Months	6 Months	12 Months	12 Months	6 Months	6 Months	6-12 Months
Change 1								
Change 2								
Change 3								
Change 4								

*Depending On Incoming Water Quality

For warranty questions, service, or help give us a call:
Monday - Friday 10 am to 5 pm PST: 1-800-992-8876

support@expresswater.com • www.expresswater.com

EXPRESS WATER INC. 12730 Raymer St, Unit 1, North Hollywood, CA 91605