

MINI S CUB 450
General Instructions



Warning

The following terms are used in the product manual to indicate the various degrees of injury that may be caused when operating this product. Note: If these steps are not followed correctly, property damage and/or personal injury may result.

△ Before operation, please read the entire instruction manual to familiarize yourself with the functions of the product. Improper operation of the product may cause damage to the product, persons and property, and may cause serious injury.

△ This is a complicated model airplane product, not a toy. It must be operated carefully and use the necessary common sense, and requires some basic technical skills. Failure to operate this product in a safe and responsible manner may result in injury or damage to the product or other property. This product is not suitable for children who are not directly supervised by adults. Without the approval of Shenzhen Top RC Hobby Tech Co.,Ltd. no attempt to disassemble, use incompatible parts or enhance the product in any way is prohibited. This manual contains safety, operation and maintenance instructions. Before assembling, setting up or using, be sure to read and follow all instructions and warnings in the manual to operate correctly and avoid damage or serious injury. Age Recommendation: Not suitable for children under 14 years of age. This is not a toy.

Safety Precautions

You are solely responsible for operating in a manner that does not endanger yourself and others or damage the product or the property of others.

Please make sure that all batteries are properly charged before using this product.

Before each operation, be sure to check all servo systems and their connections.

Do not operate your aircraft near spectators, parking areas or any other areas that may cause personal injury or property damage.

Never operate the aircraft in bad weather conditions. Poor visibility can cause the aircraft to lose direction and control.

Never point the transmitter antenna directly at the aircraft. The radiation pattern at the tip of the antenna is inherently low.

If any unstable or abnormal operation is observed at any time during the operation of the aircraft, please stop the operation of the aircraft immediately until the cause of the malfunction is found and eliminated.

Battery Usage & Charging Warnings :

CAUTION: All instructions and warnings must be followed exactly. Incorrect use of Li-Po/Li-Ion/Ni-Mh batteries can result in fire, personal injury and / or property damage.

- The battery charger included with your plane (if there be) is designed to safely balance and charge the specific Li-Po/ Li-Mh battery.
- By handling, charging or using the included battery, you shall assume all risks associated with the Li-Po/Li-Ion battery.
- If at any time, the battery begins to balloon or swell, discontinue using it immediately. If it is charging or discharging, you should discontinue and disconnect the battery from the charger.
- Continuing to use, charge or discharge the battery that is ballooning or swelling may result in fire.
- To maintain battery life, keep the battery in a dry place indoors.
- Always transport or temporarily store the battery in a temperature range of 40-100 Fahrenheit degrees (5-40 degrees centigrade). Do not store the battery or the plane in a car or under direct sunlight. If you store the battery in a car that is too hot, the battery may be damaged or even cause fire.
- Always charge a battery away from flammable materials.
- Always check carefully the battery before charging and never charge damaged batteries.
- Always disconnect the battery after charging and keep the battery cool before the next charge.
- Always constantly monitor the temperature of the battery pack while charging.
- Only use a charger specially designed to charge specific batteries.
- Never discharge Li-Po cells below 3V under load.
- Never cover warning labels with hook or loop strips.
- Never leave charging batteries unattended.
- Never charge batteries outside recommended levels.
- Never attempt to dismantle or alter the charger.
- Never allow minors to charge battery packs.
- Never charge batteries in extremely hot or cold places (recommended between 40-100 Fahrenheit degrees / 5-40 degrees centigrade) or in direct sunlight.

Packing list



Charging instruction

LED Charging indicator

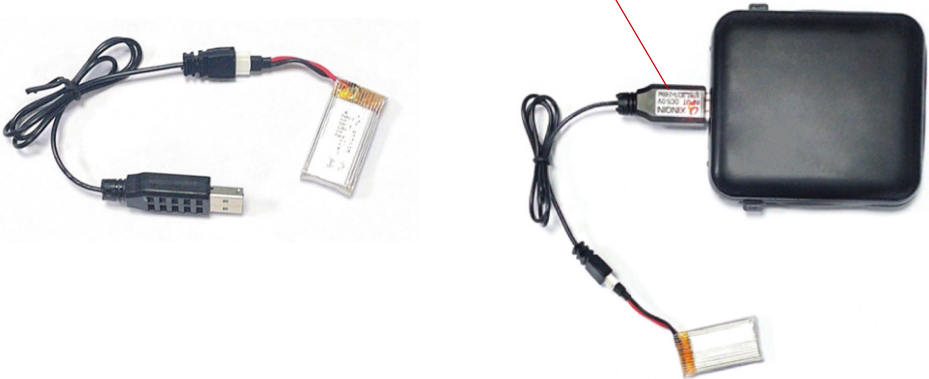

1. Unplug the battery from the aircraft.
2. Carefully insert the charger into the computer's USB port or USB adapter (5V output).
3. Connect the battery to the charger.
4. The charging process takes about 3 hours. For safety reasons, do not charge the battery for more than 4 hours. When charging, the red LED indicator is normally on. When charging is complete, the LED indicator changes to green.

Installation Notes

1. Install 4 AA batteries in the transmitter and tighten the cover with the attached screws.

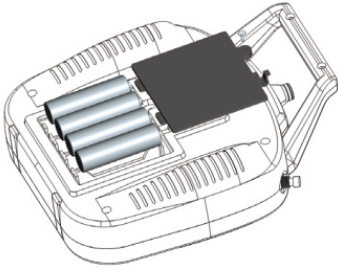

2. Insert the main landing gear into the slot of the fuselage on the bottom as shown.

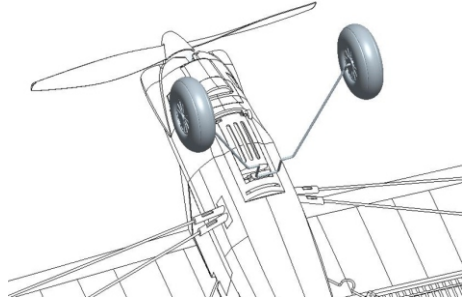

3. Insert the tail gear into the slot of the rudder as shown.

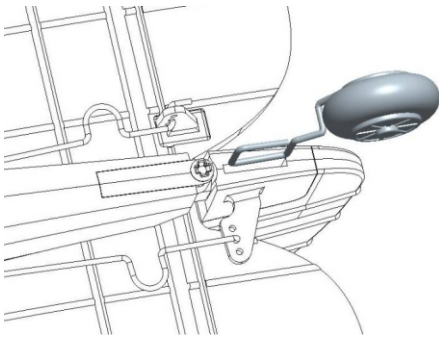

4. Power on the transmitter First. Open the battery cover and insert the male connector of the battery into the female connector of ESC, then put the battery into the battery case and lock the battery cover by plastic button.

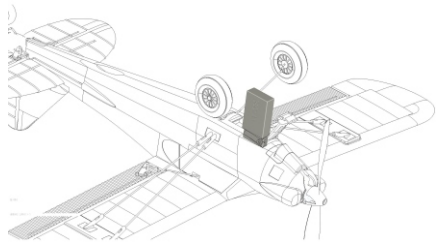

5. The setting is completed. Before starting to operate the aircraft, be sure to read and follow all instructions in this manual. In particular calibration on Page 14.

Center of Control Surfaces

Note: Before operating the steps below, please put the Top Gyro switch into EXPERT mode. Please refer to the section "Top-Gyro (Top-Gyro Flight Control System)" for more information. With the transmitter turned on and the battery connected to the ESC (and installed in the battery compartment), you can now check the center of all the control surfaces. Observe the rudder to make sure it is centered correctly, as shown below.

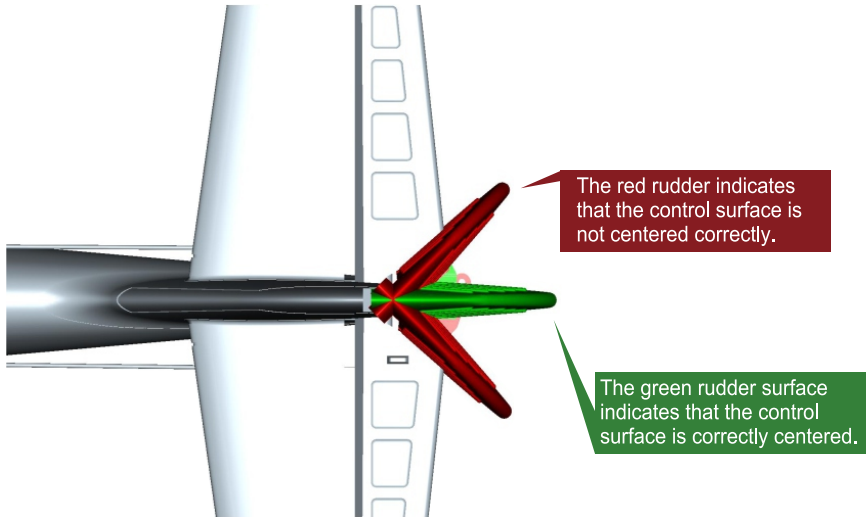

Center of Control Surfaces

Then observe the elevator to make sure it is centered correctly, as shown below.

1

The red Elevator means the control surface is not centered correctly.

2

The green Elevator indicates that the control surface is correctly centered.

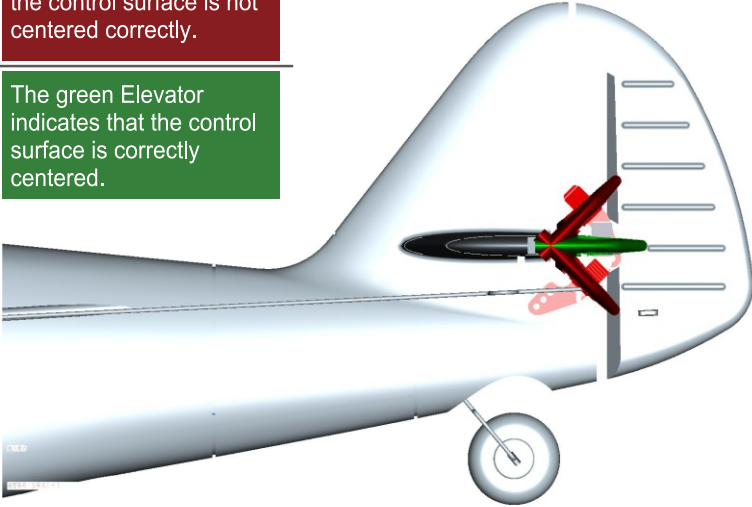

Look at the aileron again to make sure it is centered correctly, as shown below.

1

The red aileron means the control surface is not centered correctly.

2

The green aileron indicates that the control surface is correctly centered.

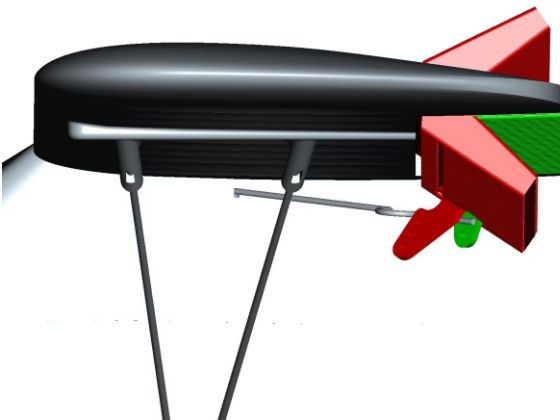

Center of Control Surfaces

If the rudder inclines left or right side, please rotate the push rod by its arc-shaped section slightly, making sure the rudder is properly centered

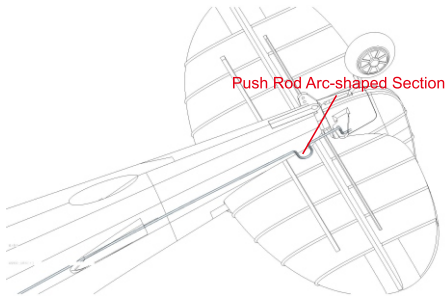

If the elevator inclines left or right side, please rotate the push rod by its arc-shaped section slightly, making sure the elevator is properly centered.

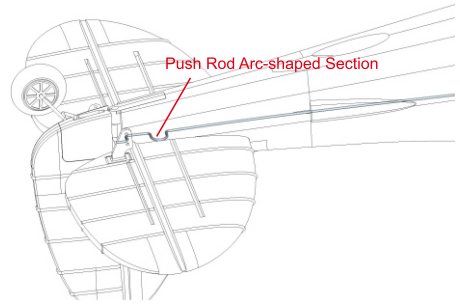

If the aileron inclines left or right side, please rotate the push rod by its arc-shaped section slightly, making sure the aileron is properly centered

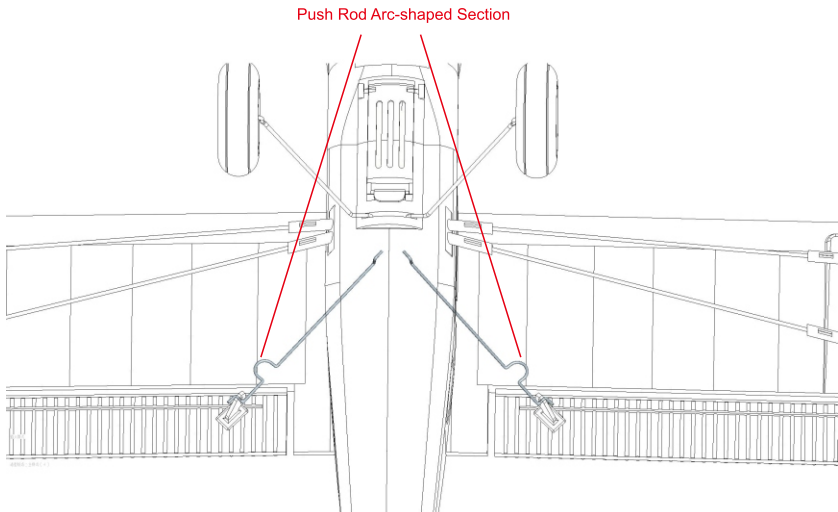

Notice

All the U clevis are pre-installed in the middle hole of control horn, customers do not need to make any change for the hole of control horn during the flight.

Transmitter Instructions

Mode 2 Transmitter



TOP-Gyro Switch



0 - Away From You-manual/ TOP-Gyro Off(EXPERT).
1 - AT the Middle-soft TOP-Gyro Assist(MIDD).
2 - Towards You- Strong TOP-Gyro Assist (BEGINNER).
This airplane comes with a pre-installed TOP-Gyro device to help make the flying of this model easier. The TOP-Gyro system offers 3 levels of assistance. With the switch in Position 0 (away from you) there is no Gyro assistance. This position is only recommended for experienced or Expert fliers. Position 1 (Midd switch position) offers soft self levelling assistance for new to intermediate fliers.

Position 2 (Beginner switch position, closest to you) offers the strongest level of assistance for the new flier. This position will strongly assist the model to stay level and fly easily.

CAUTION: It is strongly suggested to use Position 2 or 1 when you first fly this model. As you become more experienced you can progress from 2 to 1 to 0. The TOP-Gyro switch position can be changed whilst flying so if you are having difficulties we suggest to move the switch to Position 2. Note that the Calibration of the TOP-Gyro system as described on page 14 MUST be performed before the very first flight of this model.

Binding Instruction

Your model is shipped from the factory with the transmitter bound to the receiver.

Binding is the process of programming the receiver to recognize the GUID(Globally Unique Identifier)code of a single specific transmitter. When a receiver is bound to a transmitter, the receiver will only respond to that specific transmitter.

If you need to rebind for any reason, please follow these steps:

1. Keep the transmitter switch OFF, throttle joystick at bottom position **NOTICE:** Keep Top-Gyro switch at Middle or Beginner position

NOTICE: Keep the plane still in a calm environment for calculating the Top-Gyro.

2. Connect the battery to the plane, then turn on the transmitter within 5 seconds.

3. The receiver LED will flash for 3-8 seconds to bind automatically.

4. After the receiver LED stop flashing, it means the binding process is done.

Follow below steps when you operate a bound plane.

1. Power on transmitter first.

2. Connect the battery to the plane within 3 seconds.

3. The receiver LED in plane will flash and then turn to solid in several seconds.

4. Switch the Top-Gyro control stick to Top-Gyro assist level (MIDD or BEGINNER).

NOTICE: Allow the airplane stay still about 3-5 seconds in a calm environment when you first time turn on Top-Gyro, in order to calibrate and activate the Top-Gyro When the Top-Gyro starts to react, means it is activated.

5. Turn throttle stick up to max and then down to min to arm the motor.

CAUTION: Do NOT operate around people or property, otherwise it may cause serious damage!

For safety reasons, every time when you turn on the Transmitter, the throttle will be locked, follow these steps to unlock the throttle.

Note: Just keep distance from the propeller for your safety.

Turn throttle joystick to the Max position, until you hear the “beep” sound, then turn the throttle joystick to the lowest position, until you hear the “beep”, then the throttle is unlocked.

Digital Trims

Digital trims allow you to adjust the centered position of aileron, rudder or elevator. Each time when a trimmer is moved, the servo output will change one angle. If the trimmer is held, the output will scroll in that direction until the trimmer is released or the output reaches its end. When you hear a short beep sound, it means the trimmer is centered.









Mode 2 Transmitter

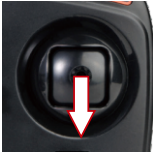
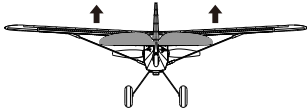

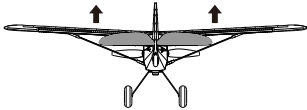
Channel Reaction Checking

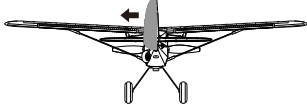
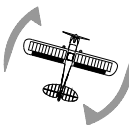
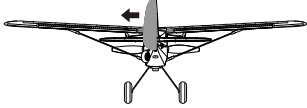
Place your plane in a neutral level position, follow below steps to check the channels reaction. Move the sticks (except the throttle stick) to see if all servo surfaces react correctly as shown in the left diagram (left throttle for example). Swing your plane to check if all servo surfaces react correctly as shown in the below diagram.

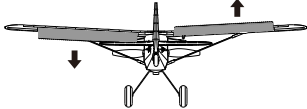
Mode 2 (Left Throttle) Shown

Transmitter Operation	Reaction	Swing The Plane	Top-Gyro Reaction
			
			
			

One-key Aerobatics Instruction



The one-key aerobatics feature allows beginner pilots to perform aerobatic actions by simply pressing the button on transmitter.

During flight, under Top-Gyro control mode, press the one key aerobatics button, the transmitter will beep several times. During the beeping, simply move the aileron stick to either direction for auto-roll. Or move the elevator stick to either direction for auto-loop.

One-key U-turn

The airplane comes with one-key U-turn function, which enables the plane to U-turn by the opposite direction that the airplane takes off. Follow below steps to activate the function.

1. Place your plane heading to the take-off direction.
2. Do NOT unlock the throttle , press the activation button and hold for several seconds until you hear a " beep " sound , the rudder surface will respond , meaning the one-key U-turn function is now activated.

One-key
U-turn
Activation

One-key
U-turn
Switch



NOTICE

Every time when you power on the plane, it requires to activate the one-key U-turn function. To use this function during flight , press one-key U-turn switch button , the plane will turn around automatically back to the opposite direction where it takes off.

To quit, just press again the switch button, or control any servo stick (rudder / elevator), the plane will back to your control immediately.

No matter you fly the plane under manual control or Top-Gyro assist mode, when you turn on the one-key U-turn function, the plane will enter Top-Gyro assist mode automatically to help stably flying back.

When you quit this function, the airplane will back to what the control mode it was.

CAUTION: This function is bound to the receiver, instead of to the transmitter, which means the plane Will U-turn ONLY to the opposite direction that the plane takes off. It also means when the plane U-turns and passes the position where you activated the function, the one-key U-turn function will NOT U-turn the plane back to the take-off position.



Notice

The flying range of this micro model is approximately 150 metres from the remote controller.

Due to the size of the micro plane we recommend flying up to 100 metres. For the average person this is basically the limit of vision. It is recommended to fly within this range. If the nose and tail are not clearly distinguished, it will be harder to fly the model, and you may lose orientation resulting in a crash landing.

If there are buildings or signal/telephone towers around the flying field, it is recommended not to fly near them due to the risk of collision or reduced range.

It is not recommended to fly your micro model in wind speeds that exceed Level 4 (25 km/h, 15 mph, 14 knots or 6 m/s)

Top-Gyro System Calibration



1. Place the model on a flat horizontal surface.
2. Turn the throttle stick to min position.
3. Power on the transmitter and the receiver.
4. Do NOT unlock the throttle.
5. Keep the sticks as above picture for several seconds.
6. When you hear a " beep " sound, it means the Top-Gyro system is calibrated based on the horizontal level you are keeping it.

* This process should be performed before the very first flight of the model.

Propeller Saver Instruction

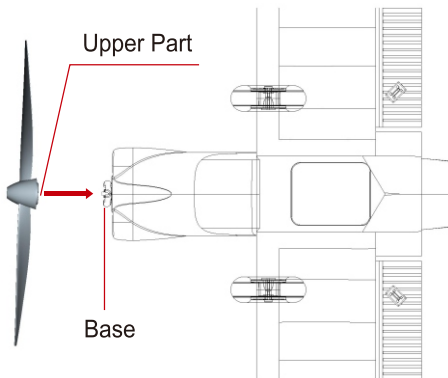

The propeller saver protects the propeller from damage, and prevent the electronic components from high current loads.

When the airplane hits any obstacles, the propeller will come loose from its mount. To install the propeller back to the base, insert the prop adaptor centrally through the motor shaft, and hearing a "click" sound to ensure it is secured.

Propeller Replacement

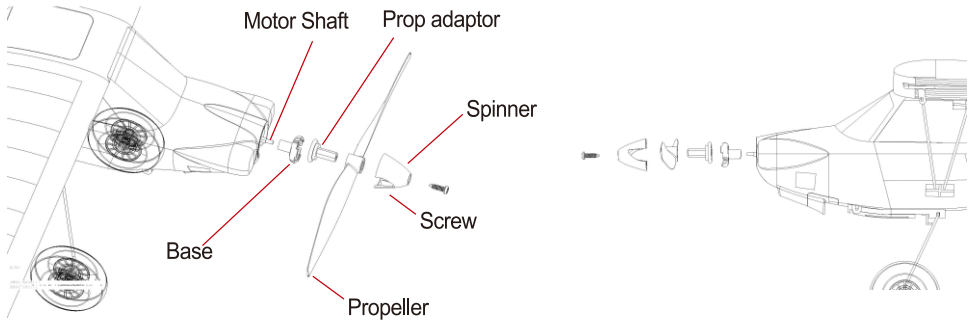

Follow below steps to replace broken propeller. You will need the help of a Philips screw driver and pliers (not included).

1. Take off the spinner and propeller, by loosening the screw with a Philips screw driver
2. Take off the prop adaptor carefully. If it is too tight, use pliers to help.
3. Replace any part broken.
4. Install all parts back by inverted orders to finish the replacement.

Low Voltage Warning

After flying about 10 minutes with full capacity battery, if transmitter makes continuous “Beep” sound, this means the voltage of the battery in the airplane is too low, please land the airplane safely asap, or the airplane may lose power and land out of control.

Flight Checklist

NOTE: This checklist is NOT intended to replace the content included in this instruction manual. Although it can be used as a quick start guide, we strongly suggest that you read all though the manual completely before proceeding.

Always turn the transmitter on first.

Ensure the throttle control stick is at bottom position before connecting the battery.

Fly the model (hand-launch or take off from a flat / level surface).

Land the model (on a flat / level surface.)

Unplug the battery from ESC.

Always turn off the transmitter last.

Addendum

Thanks for purchasing Top RC Hobby's Mini S CUB 450.

If you have the Open TX transmitter, we are glad to tell that your Open TX transmitter can be compatible with our above micro planes listed.

Please download the firmware to your Open TX Transmitter, below is the link and firmware type. If you already have this firmware on your Open TX Transmitter, then you could bind our micro planes and fly it. If any questions, just feel free to contact us info@toprchobby.com.

Link:

<https://github.com/pascallanger/DIY-Multiprotocol-TX-Module/releases>

MULTI



Firmware Type:

mm-stm-serial-aetr-vx.x.x.x.

Sub_protocol TOPRC-2

Models: Top RC Hobby Spitfire, P51D, BF-109

CH1	CH2	CH3	CH4	CH5	CH6	CH7	CH8	CH9
A	E	T	R	GYRO	CALIB	FLIP	RTN_ACT	RTN

Protocol Name	Protocol Number	Sub_Protocol 0	Sub_Protocol 1	Sub_Protocol 2	Sub_Protocol 3	Sub_Protocol 4	Sub_Protocol 5	Sub_Protocol 6
V761	48	3CH	4CH	TOPRC				





Main electronics board

The main electronics board has connection ports for DSM satellites and S-BUS receivers. (The old version does not include the connection ports for DSM and S-BUS.)

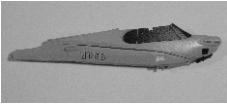
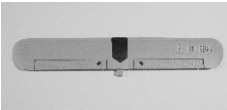
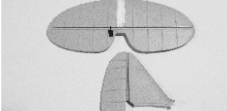
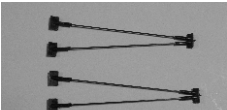

By connecting a suitable satellite or receiver to one of these ports you can see the appropriate transmitter to fly this Mini S CUB 450.

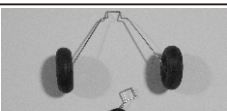
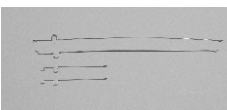
Spare Parts List for S CUB450

Fuselage	
Main Wing	
Horizontal Tail	
Wing Strut	
Propeller+Spinner set	
Landing Gear set	
Control Rod set	
Gearbox	
Receiver with Gyro and Surface Mounted Servos wire length:70mm	

Coreless Motor wire length:70mm	
Propeller Protector Mount: 1pcs	
Lipo 1s 3.7V 400mAh	
Wing servo 2g wire length:70mm	
USB Charger	
Control horns 2pcs	
4 channel Transmitter Mode 1	
4 channel Transmitter Mode 2	

Radio Control Micro Planes General Instructions



Shenzhen Top RC Hobby Tech Co.,Ltd

www.toprchobby.com

Tel: 0086-(0)755-27908315

Fax: 0086-(0)755-27908325

AGE 14+    **CE FC**

Made in China

**FCC NUMBER: 2A8F5-MODELAIRPLANE
CE NUMBER: CTB220815028CX-ZS**