



**LIGHT^{MY}
BRICKS**



**LEGO OPTIMUS PRIME #10302
LIGHT KIT
INSTALLATION GUIDE**

Light My Bricks



LEGO OPTIMUS PRIME 10302 INSTALLATION GUIDE

Hi There!

We're here to help you get started on the LEGO Optimus Prime 10302 Light Kit.

This PDF details the instructions for the LED light kit only. If you are wishing to purchase this product, please [click here](#) to view the product page.

If you run into any issues, please refer to the troubleshooting section towards the end of this guide.

Have fun and enjoy!



PACKAGE CONTENTS: ASSORTED BRICKS:



- 4 x Orange 30cm Bit Light
- 4 x Cool White 30cm Bit Light
- 8 x Yellow 15cm Bit Light *
- 1 x Blue 30cm Bit Light
- 2 x Red 30cm Bit Light
- 1 x Blue 30cm Large Bit Light
- 1 x Cool White 30cm Large Bit Light
- 1 x Warm White Light String



- 4 x 8-Port Expansion Board *
- 7 x 2-Port Expansion Board
- 1 x Pulse Effects Board
- 1 x Flicker Effects Board
- 1 x Gun Effects Board
- 2 x Wireless Power Connectors



- 2 x 5cm Connecting Cables
- 7 x 15cm Connecting Cables
- 1 x 50cm Connecting Cables



- 1x USB Power Cable
(Power Source not Included)

- 2 x 1x1 Round Plate - Trans Dark Blue
- 4 x 1x1 Round Plate Open Stud - Trans Orange
- 8 x 1x1 Round Plate - Trans Orange
- 4 x 1x2 Plate - Red
- 2 x 1x2 Plate - Trans Red
- 3 x 1x2 Plate - Trans Clear
- 1 x 2x2 Plate W Rounded Bottom - Trans Clear
- 1 x 1x1 Round Plate Open Stud - Black
- 1 x 1x1 Bracket - Light Grey
- 1 x 1x2 Plate - Black
- 1 x 2x2 Plate - Dark Grey

* Indicates components which include spares

Contents

Before You Begin	5
Blueprint	8
Instructions	10
Final Product	64
Troubleshooting	65
Contact	70

Before You Begin

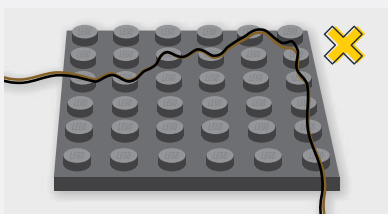
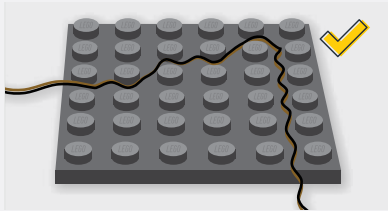

Laying cables in between and underneath bricks

Cables can fit in between and underneath LEGO® bricks, plates, and tiles providing they are laid correctly between the LEGO® studs. Do NOT forcefully join LEGO® together around cables; instead ensure they are laying comfortably in between each stud.

CAUTION: Forcing LEGO® to connect over a cable can result in damaging the cable and light.

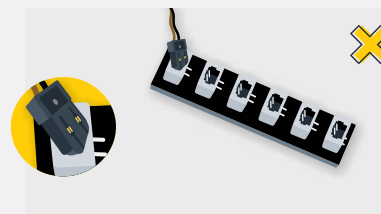
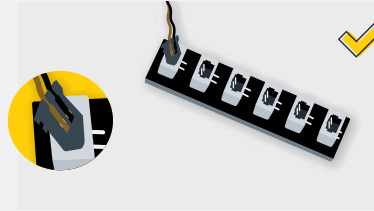

Connecting Cable Connectors To Expansion Boards

Take extra care when inserting connectors to ports of Expansion Boards. Connectors can be inserted only one way. With the expansion board facing up, look for the soldered “=” symbol on the left side of the port. The connector side with the wires exposed should be facing toward the soldered “=” symbol as you insert into the port. If a plug won’t fit easily into a port connector, do not force it.

Incorrectly inserting the connector can result in bent pins inside the port or possible overheating of the expansion board when connected.

Before You Begin



Connecting Cable Connectors To Strip Lights

Take extra care when inserting connectors to ports on the Strip Lights. Connectors can be inserted only one way. With the Strip Light facing up, ensure the side of the connector with the wires exposed is facing down. If a plug won't fit easily into a port connector, don't force it. Doing so will damage the plug and the connector.



Connecting Micro Cable Connectors To Micro Expansion Board Ports

Take extra care when inserting the micro connectors to micro ports of Micro Expansion Boards. Connecting Micro Bit Lights to Micro Expansion Boards is similar to connecting lights and cables to Strip Lights. With the expansion board facing up, ensure the side of the connector with the wires exposed is facing down. If a plug won't fit easily into a port connector, do not force it. Use your fingernail to push the plastic part of the connector to the micro port.

Before You Begin

Installing Bit Lights Under Lego® Bricks And Plates

When installing Bit Lights under LEGO® pieces, ensure they are placed the correct way up (Yellow LED component exposed). You can either place them directly on top of LEGO® studs or in between.



BLUEPRINT

Autobot Mode - Part 1

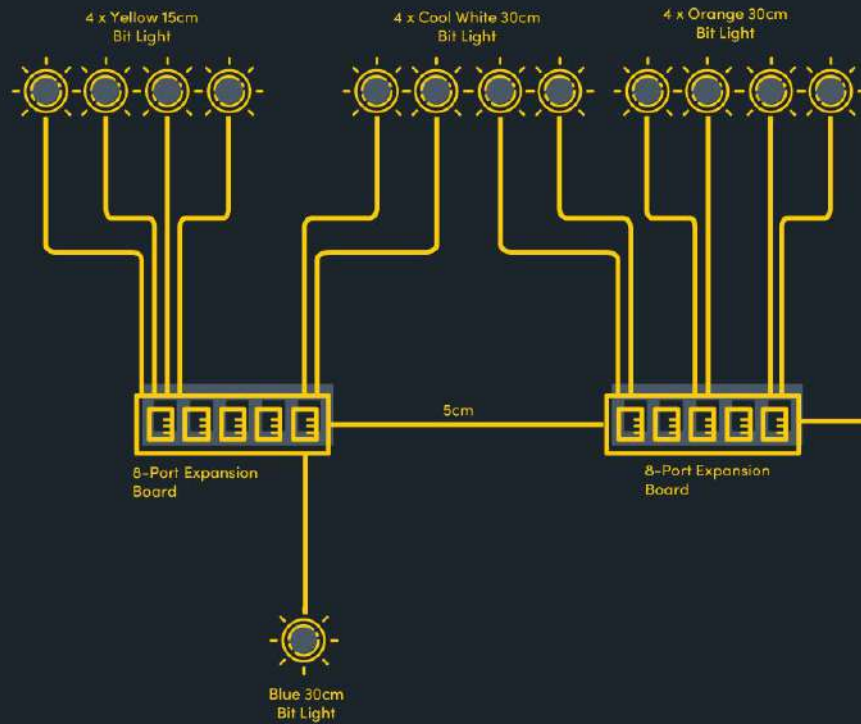

Part 2

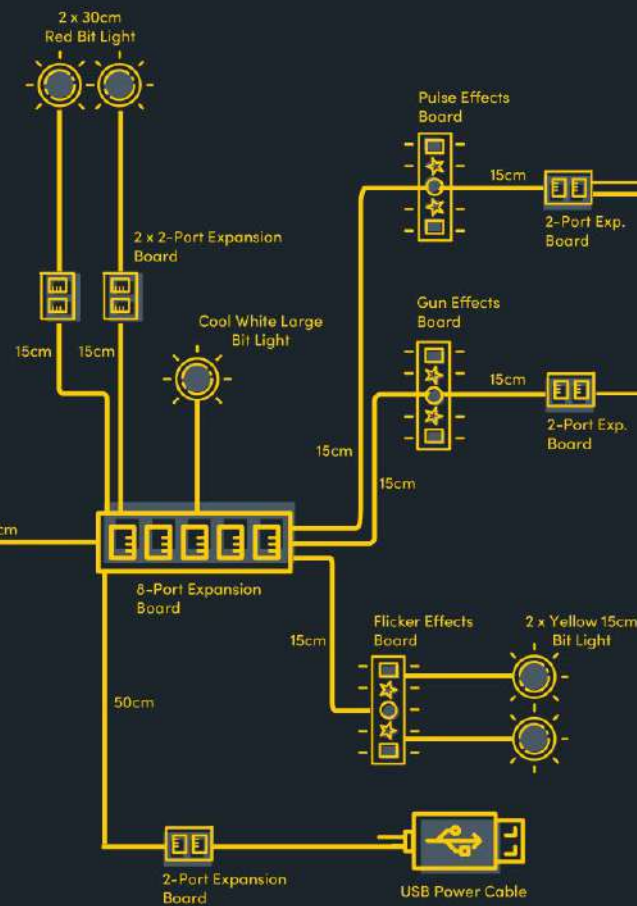

Weapons

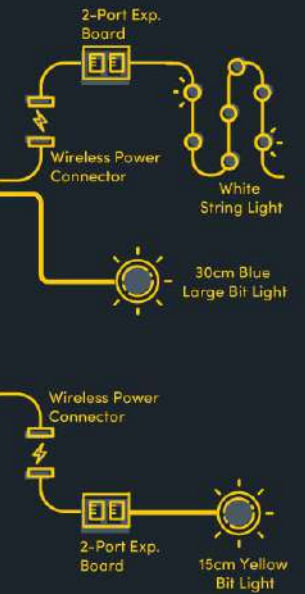

BLUEPRINT

Truck Mode

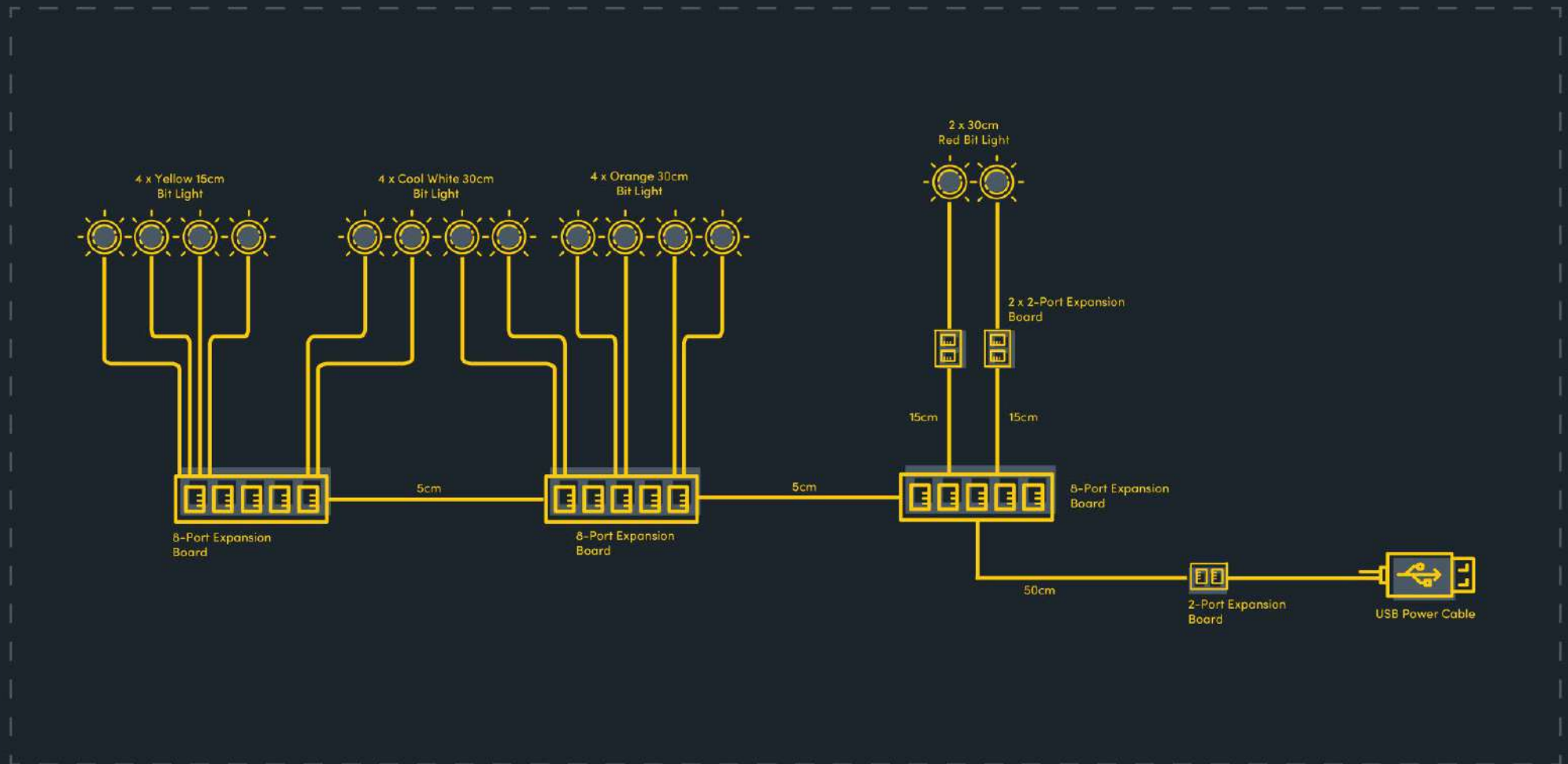



INSTRUCTIONS

To ensure a smooth installation of your light kit, please read and follow each step carefully. If you run into any issues, please refer to the online troubleshooting guide.

Instructions for Autobot Mode: Page 11-50

Instructions for Truck Mode: Page 51-63





AUTOBOT MODE INSTRUCTIONS

Light Kit Guide for installation into Autobot Mode.

If you intend to display your Optimus Prime 10302 in Autobot form, follow the instructions below.



1

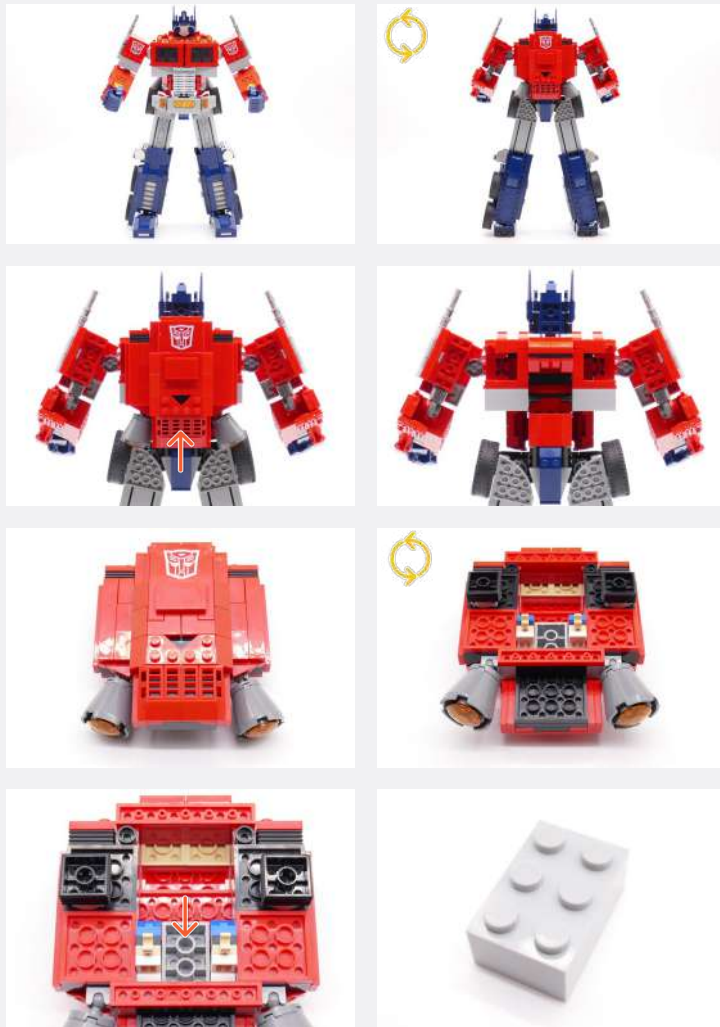

2

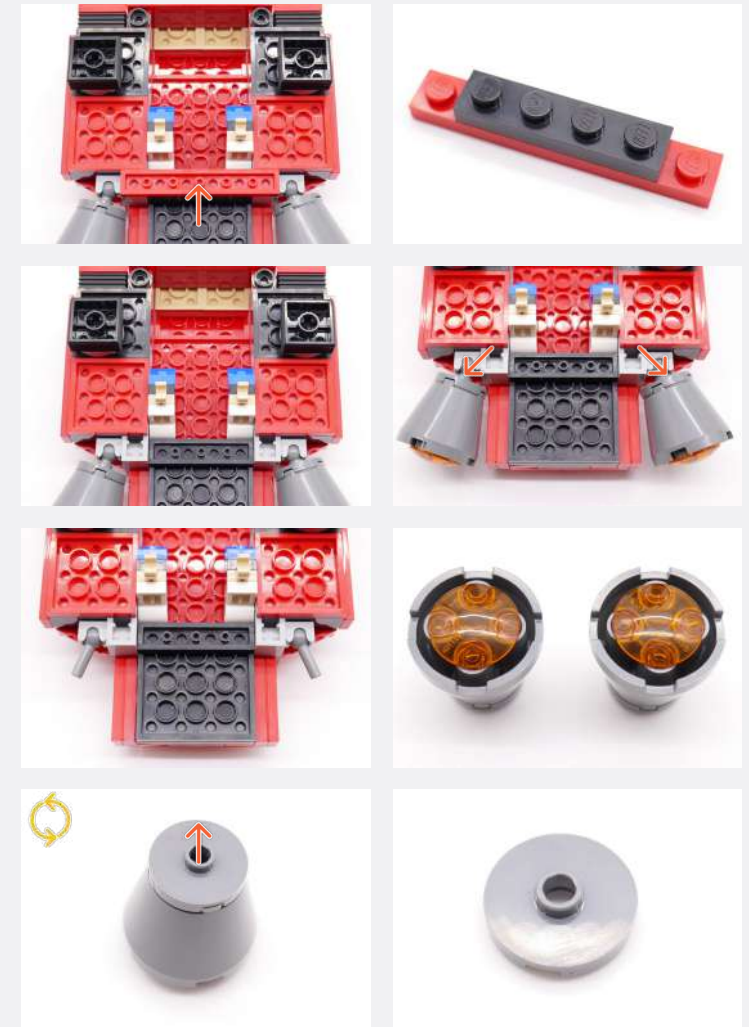

Legend

- DISCONNECT
- CONNECT / RECONNECT
- TURN / FLIP
- DIRECTIONAL
- TWIST / BRAID
- POWER ON TEST
- NOTE ICON

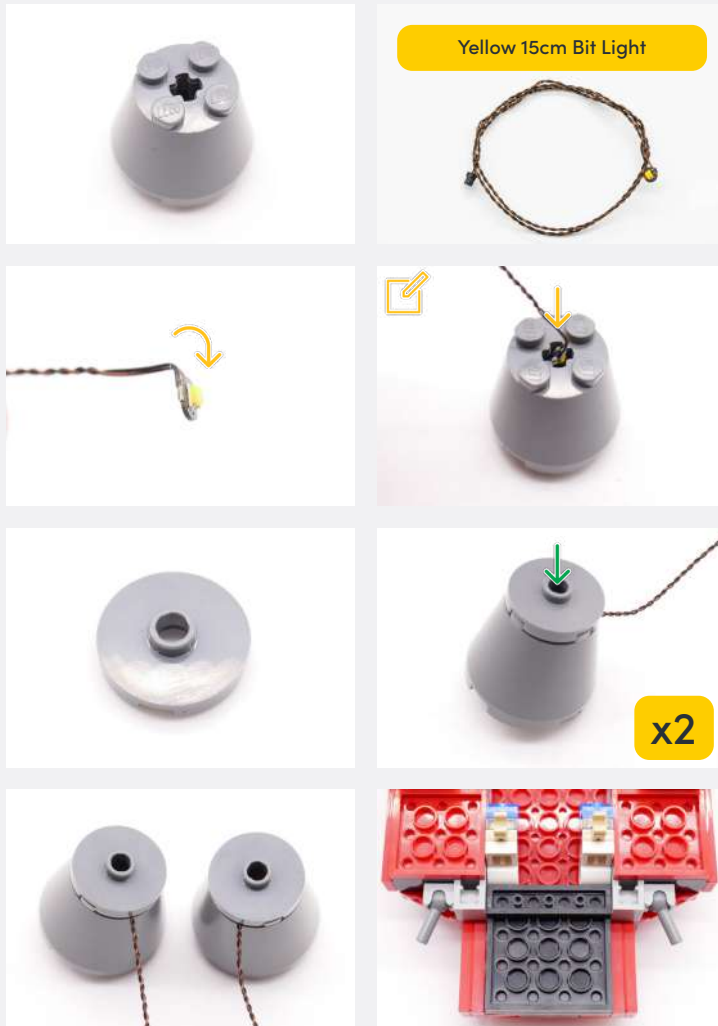

Push the Bit Light all the way down to the Orange 2x2 Plate w/ Rounded Bottom

3

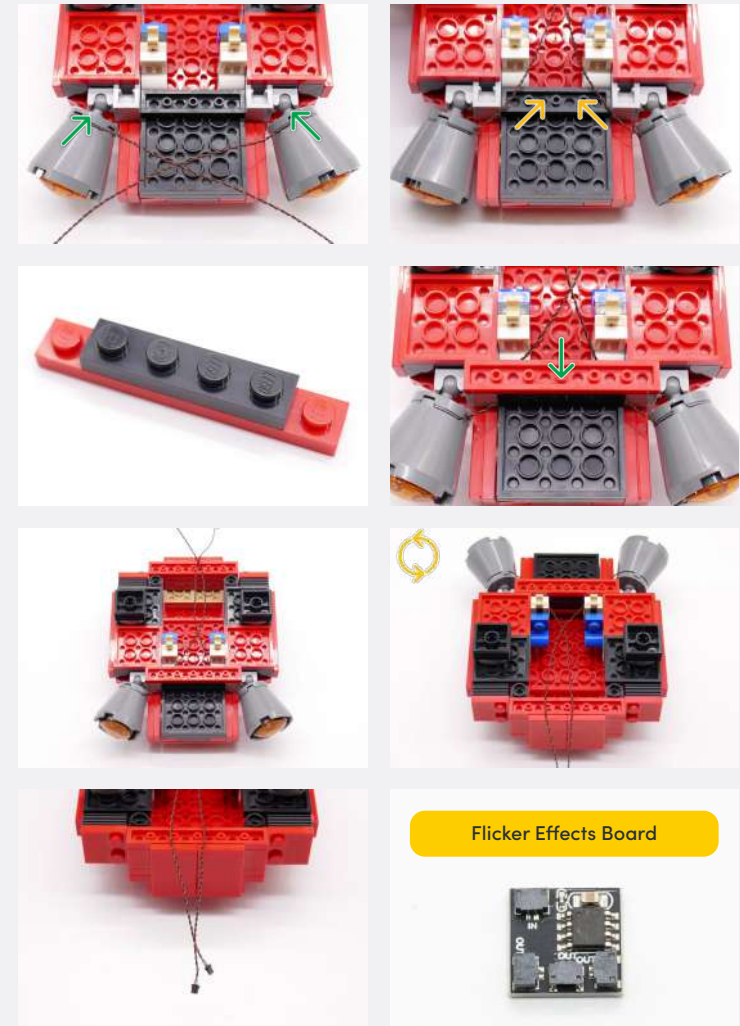

Legend DISCONNECT CONNECT / RECONNECT TURN / FLIP DIRECTIONAL TWIST / BRAID POWER ON TEST NOTE ICON

✂ Connect the two Bit Lights to the 'OUT' port of the Flicker Effects Board

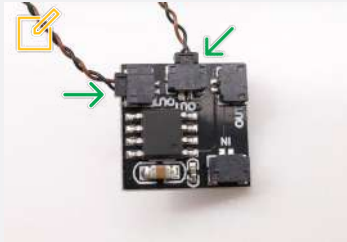

4

USB Power Cable

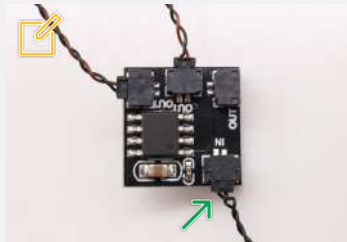

✂ Connect the USB Power Cable to the 'IN' Port of the Flicker Effects Board

✂ Twist the cables but exclude the USB Power Cable

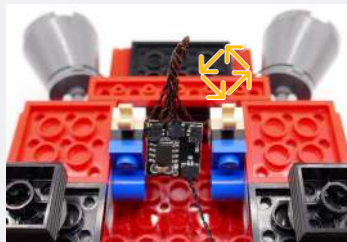
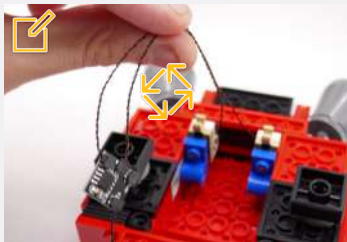

✂ Connect to a power source - 5V USB Power Bank, 5V USB Wall Adaptor, or USB to AA Battery Pack (sold separately)



5

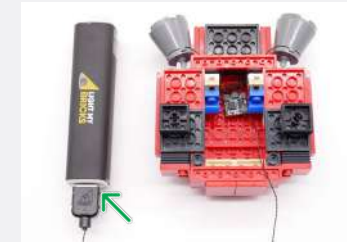

15cm Connecting Cable

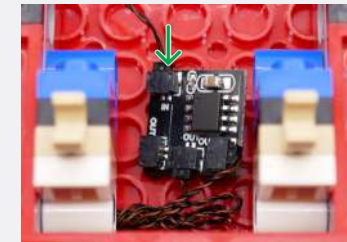

Legend

- DISCONNECT
- CONNECT / RECONNECT
- TURN / FLIP
- DIRECTIONAL
- TWIST / BRAID
- POWER ON TEST
- NOTE ICON

6



Gun Effects Board



2 x 15cm Connecting Cable

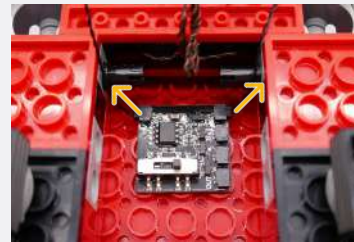
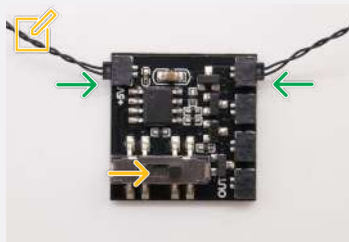

Connect a 15cm Connecting Cable to the '5V+' port and the other 15cm Connecting Cable to an 'OUT' port of the Gun Effects Board

Push the switch to the right

Legend

- DISCONNECT
- CONNECT / RECONNECT
- TURN / FLIP
- DIRECTIONAL
- TWIST / BRAID
- POWER ON TEST
- NOTE ICON

Pulse Effects Board



2 x 15cm Connecting Cable



Connect a 15cm Connecting Cable to the 'IN' port and the other 15cm Connecting Cable to an 'OUT' port of the Pulse Effects Board

Push the switch to the left

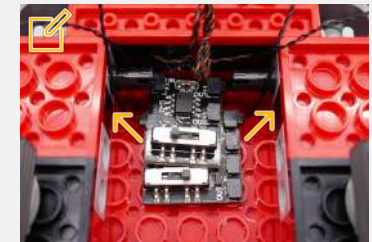
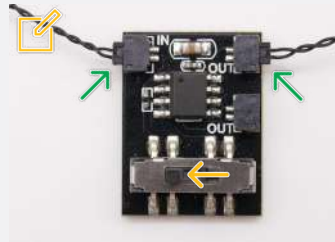

Ensure the cables connected to the 'IN' port are going towards the left side of the jetpack

Ensure the cables connected to the 'OUT' port are going towards the right side of the jetpack

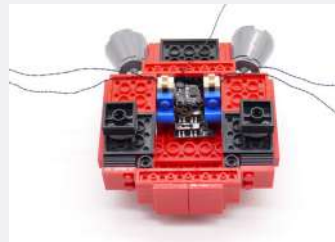
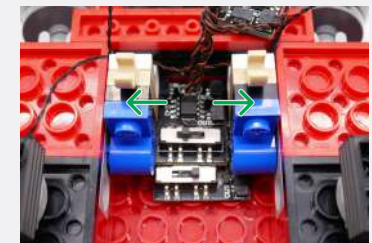

7

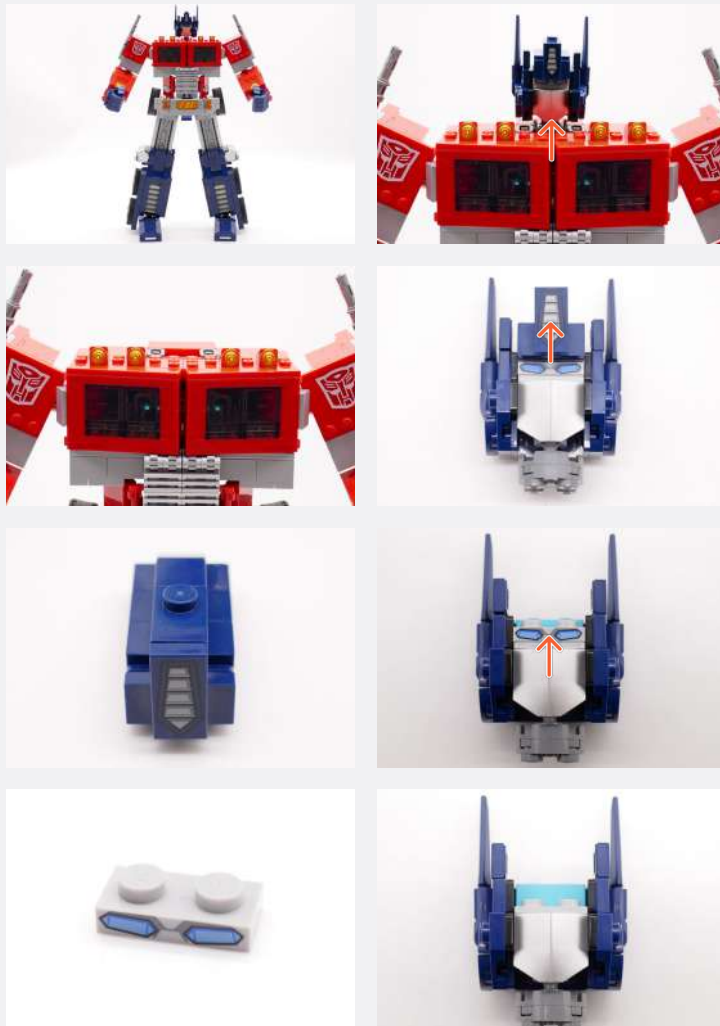

Make sure Bit Light is positioned facing backward

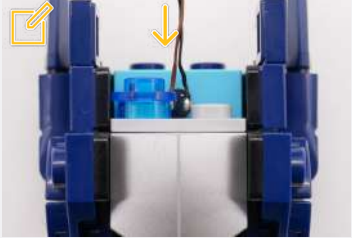
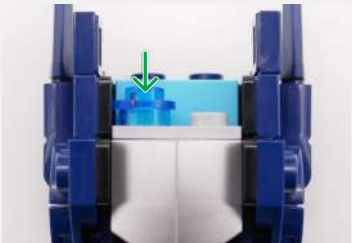
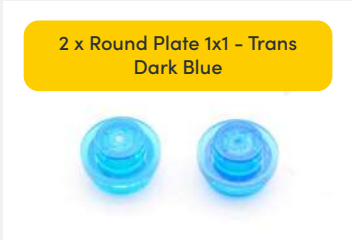

Legend → DISCONNECT → CONNECT / RECONNECT ↻ TURN / FLIP → DIRECTIONAL ↺ TWIST / BRAID ✨ POWER ON TEST 📝 NOTE ICON

8

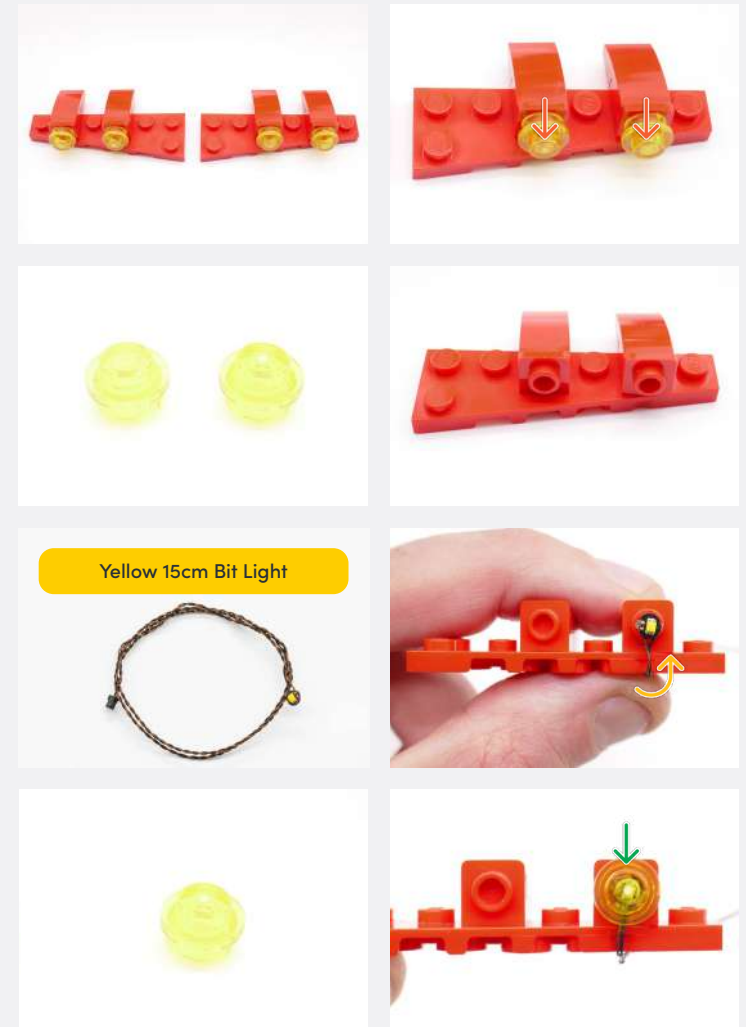
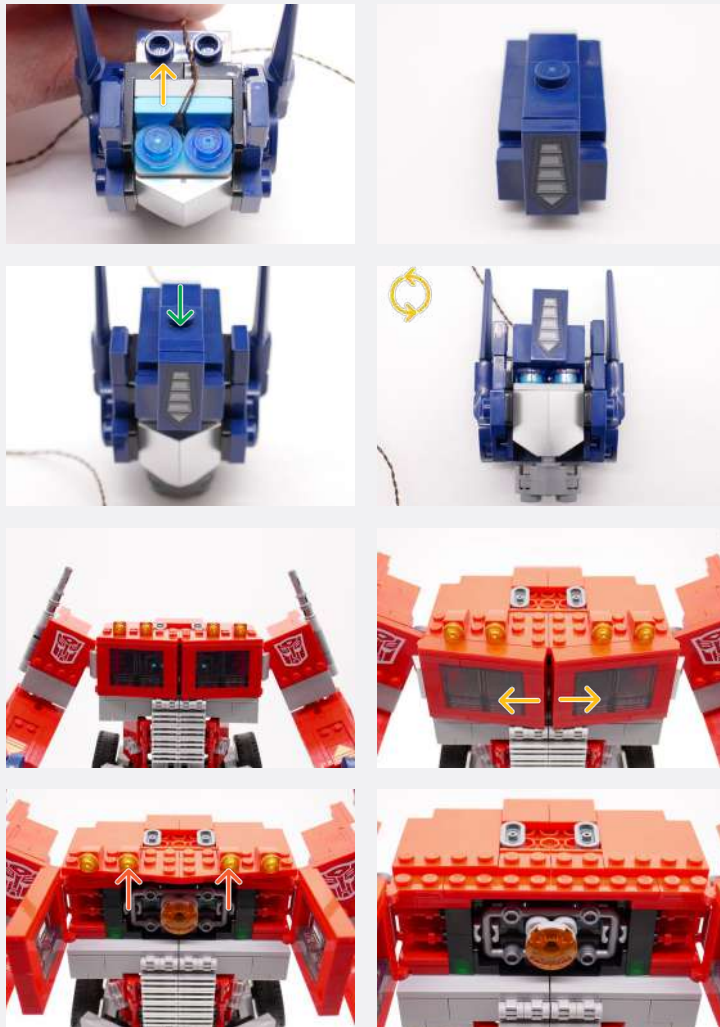

Legend → DISCONNECT → CONNECT / RECONNECT ↻ TURN / FLIP → DIRECTIONAL ↻ TWIST / BRAID ✨ POWER ON TEST 📝 NOTE ICON

Yellow 15cm Bit Light

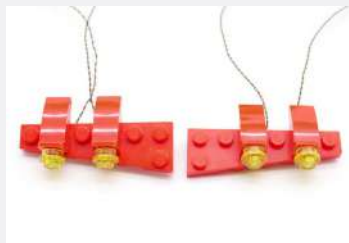
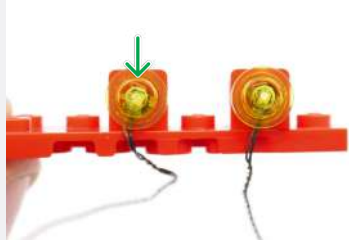
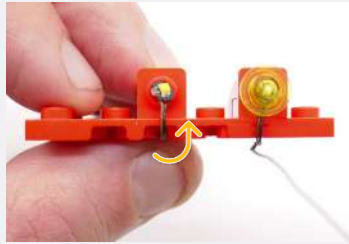

Repeat step 8 for the opposite side

9

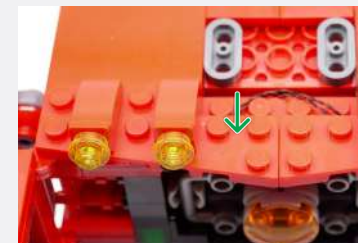
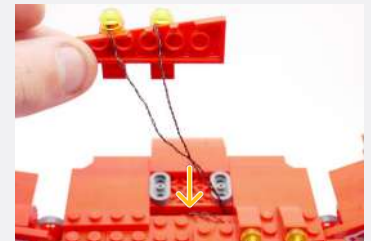
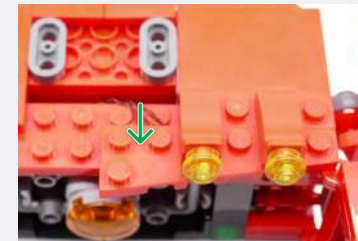
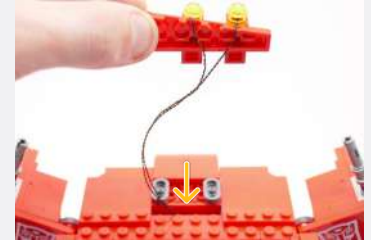
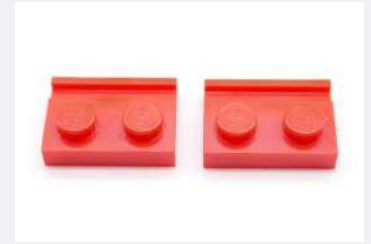
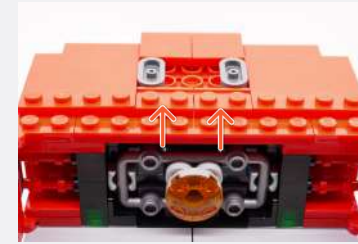

Legend → DISCONNECT → CONNECT / RECONNECT ↻ TURN / FLIP → DIRECTIONAL ↻ TWIST / BRAID * POWER ON TEST 📝 NOTE ICON

10

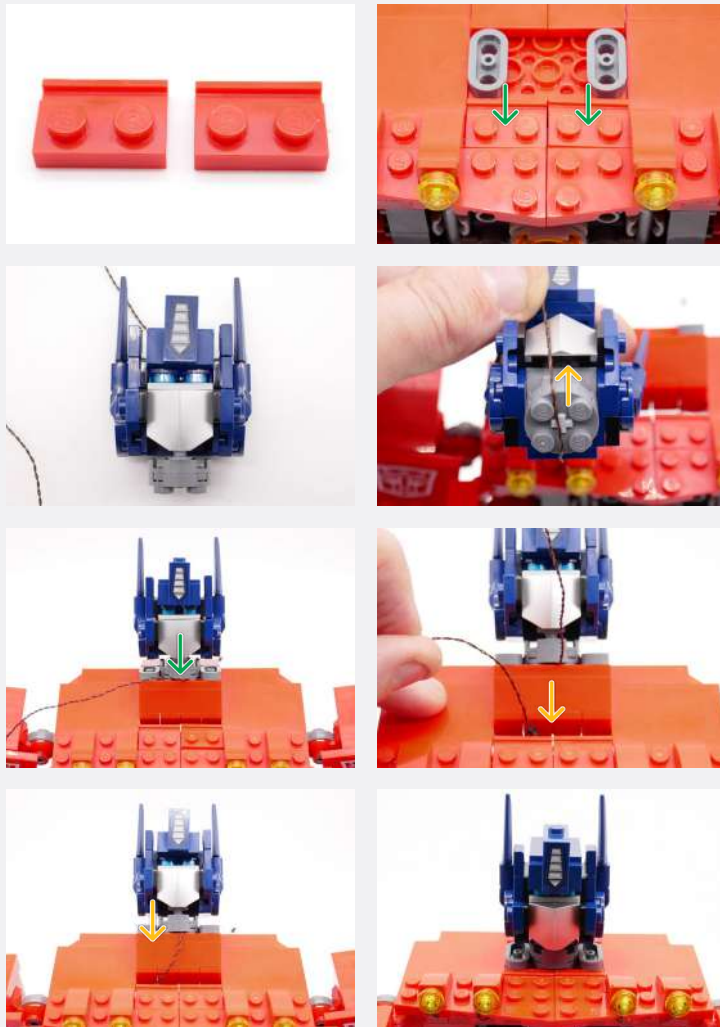

11

Twist the four Yellow 15cm Bit Lights

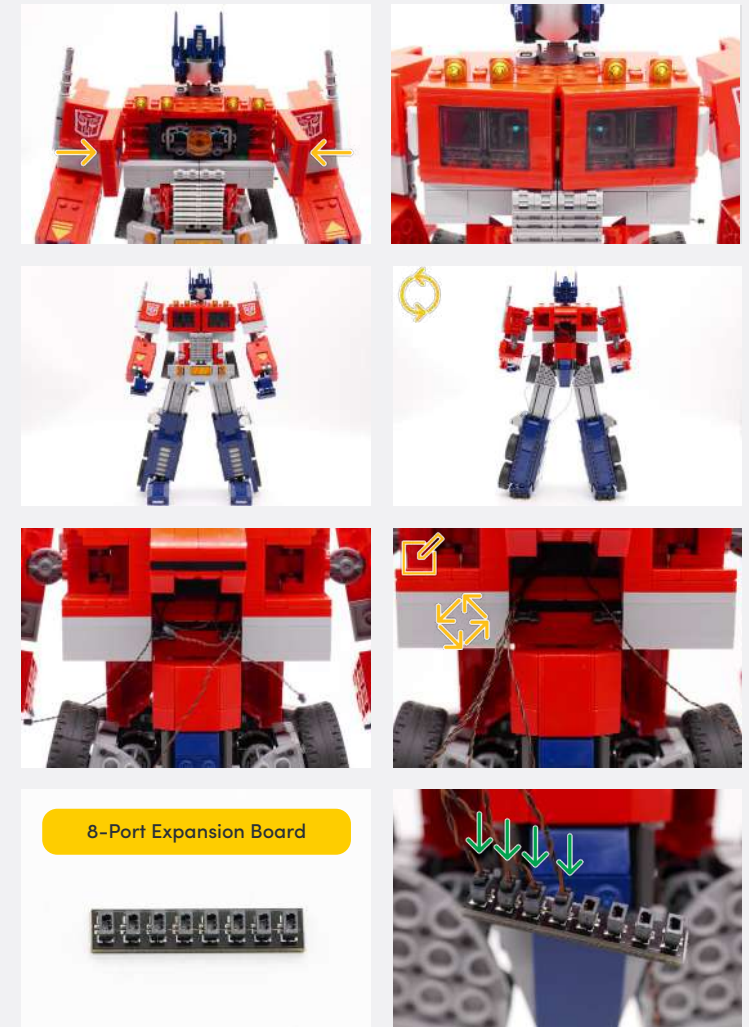

8-Port Expansion Board

Legend

- DISCONNECT
- CONNECT / RECONNECT
- TURN / FLIP
- DIRECTIONAL
- TWIST / BRAID
- POWER ON TEST
- NOTE ICON

✍ Connect the Blue 30cm Bit Light from the head

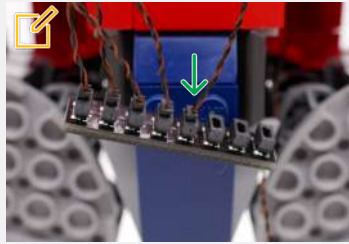
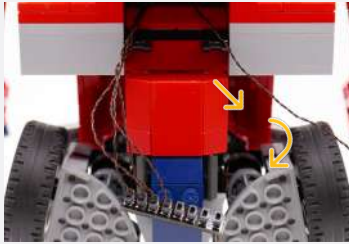

12



USB Power Cable

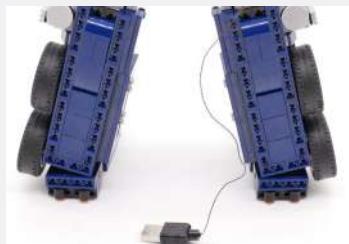
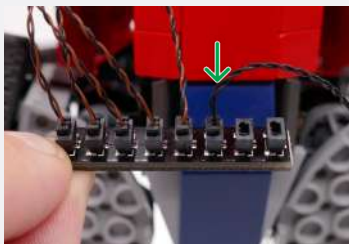

✍ Connect the other end to a power source



13

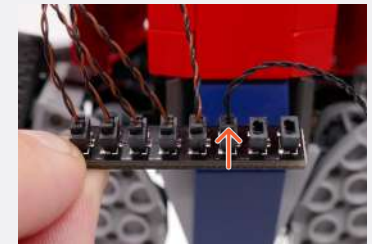
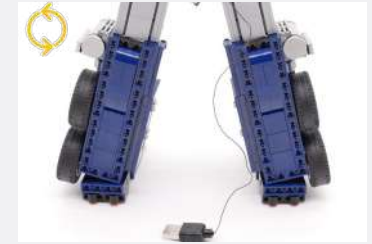

14

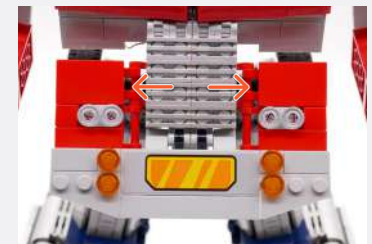
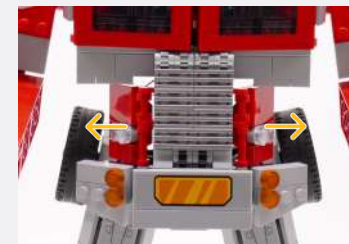

Legend



15

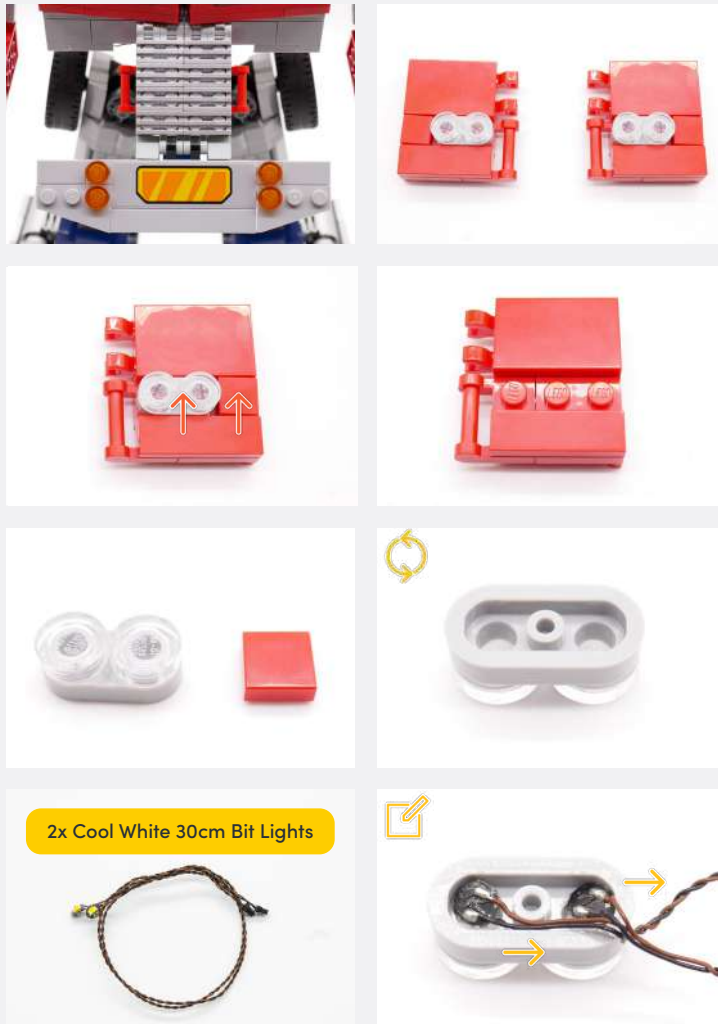

2x Cool White 30cm Bit Lights

Ensure the LED is facing downwards

Repeat step 15 to mirrored side

16

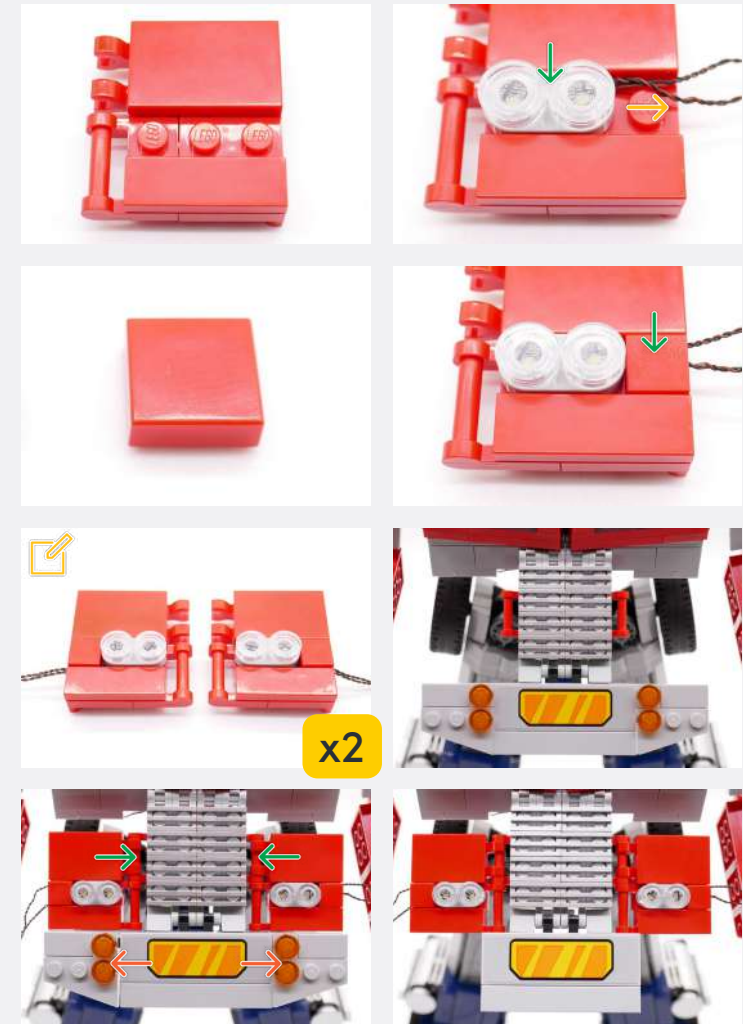

x2

Legend → DISCONNECT → CONNECT / RECONNECT ↻ TURN / FLIP → DIRECTIONAL ↻ TWIST / BRAID * POWER ON TEST 📝 NOTE ICON

17

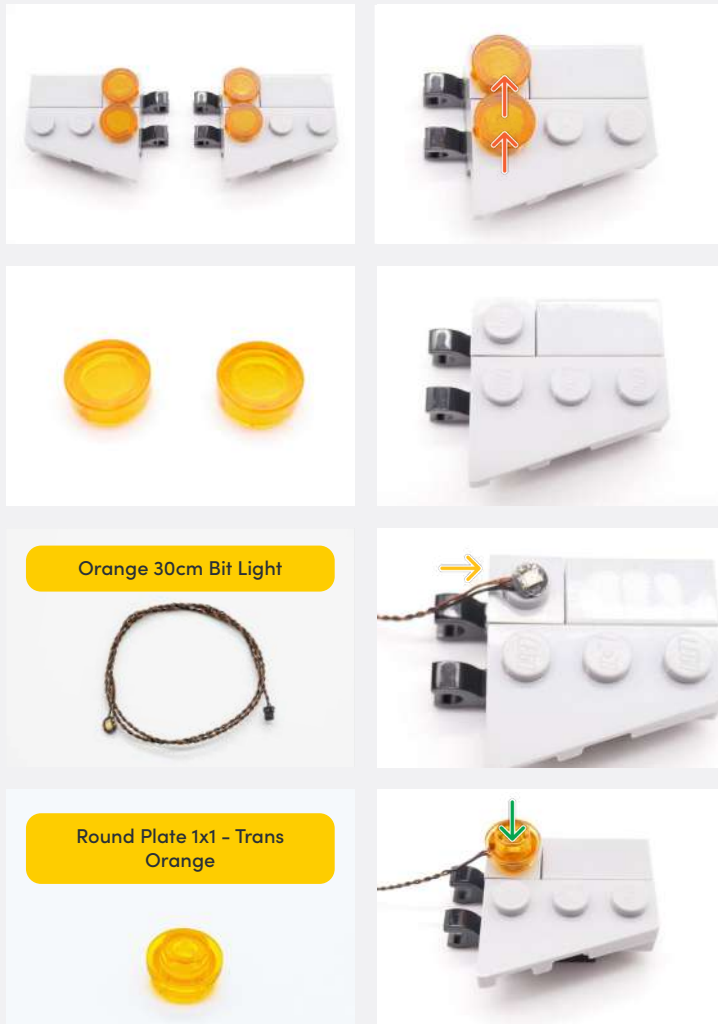

Repeat Step 17 for the opposite side

18

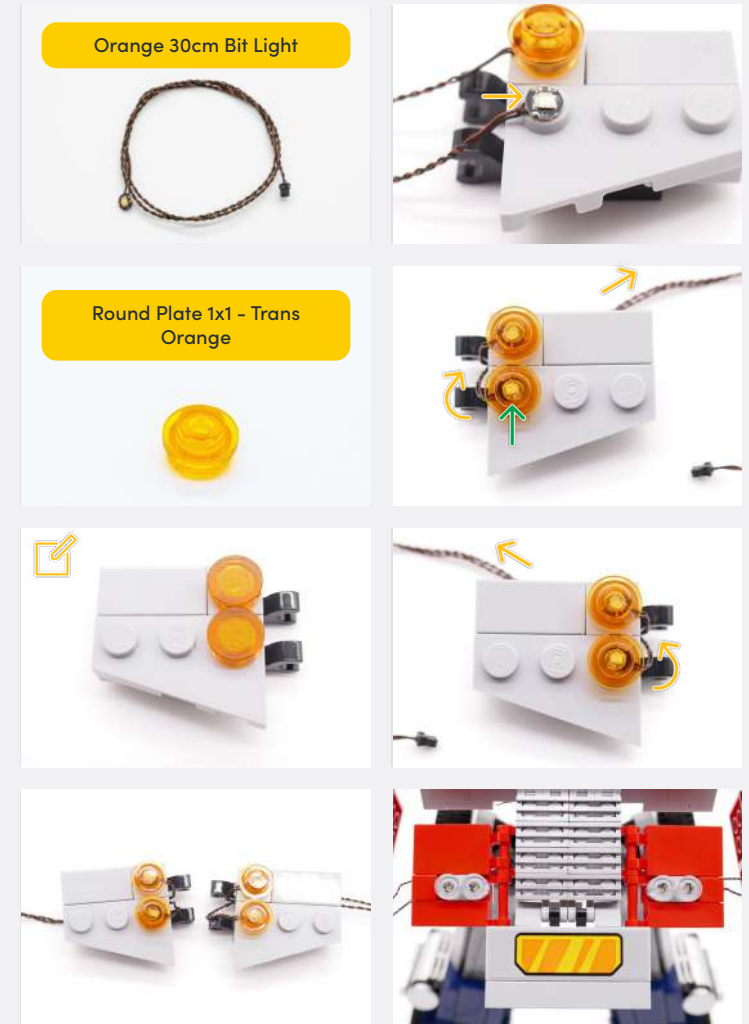

Legend → DISCONNECT → CONNECT / RECONNECT ↻ TURN / FLIP → DIRECTIONAL ↻ TWIST / BRAID * POWER ON TEST 📌 NOTE ICON

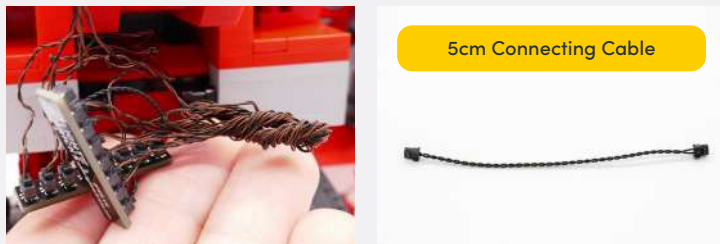
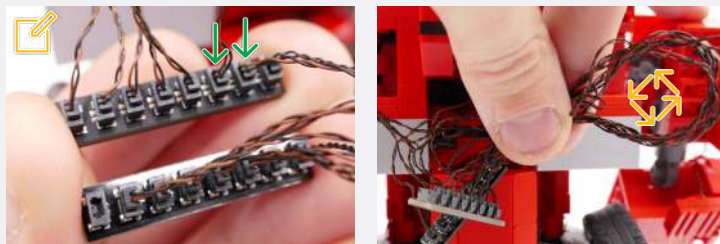
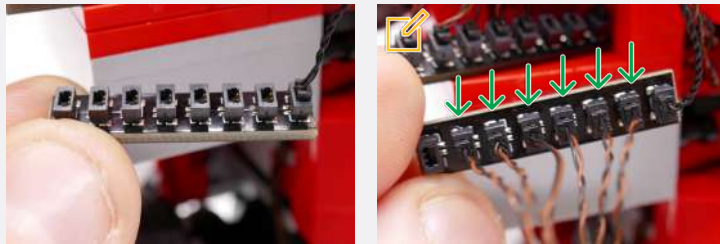
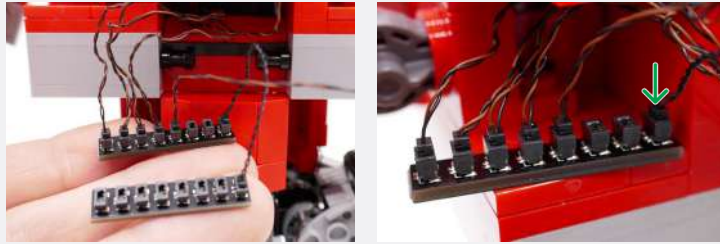

✂ Connect any of the six Bit Lights from Step 15 and 17 to the 8-Port Expansion Board with seven free ports

✂ Connect the two remaining Bit Lights to the other 8-Port Expansion Board

✂ Connect the 5cm Connecting Cable to the remaining port on the 8-Port Expansion Board

✂ Ensure the 5cm Connecting Cable is freely hanging out after fitting the Expansion Boards into the gap

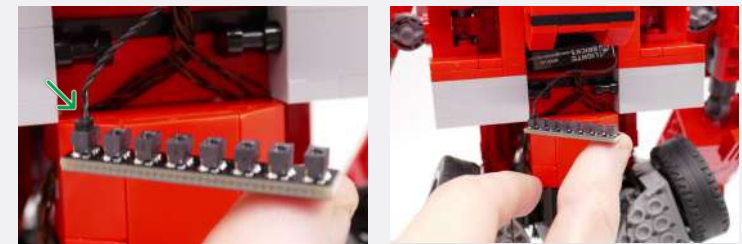
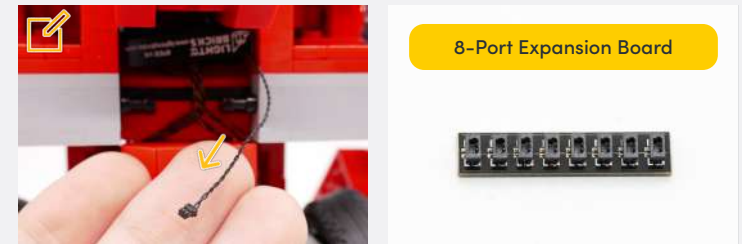
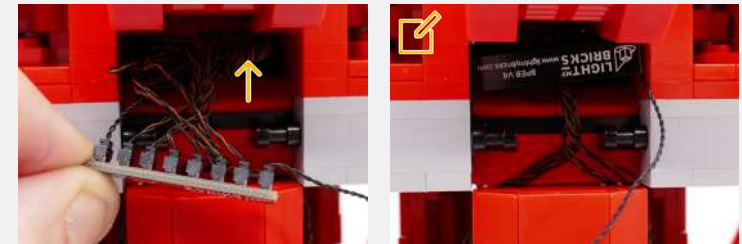
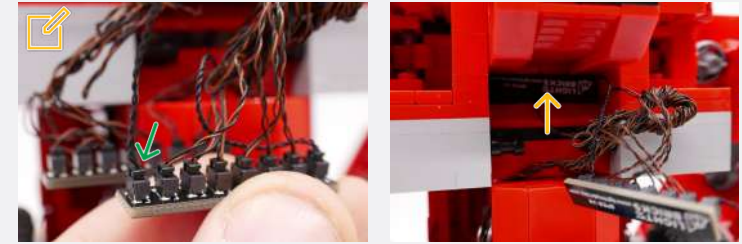

Legend → DISCONNECT → CONNECT / RECONNECT ↻ TURN / FLIP → DIRECTIONAL ↻ TWIST / BRAID ✨ POWER ON TEST ✂ NOTE ICON

20



Connect the other end to a power source

21

Optional - Tilting head back will help to hold expansion boards in cavity

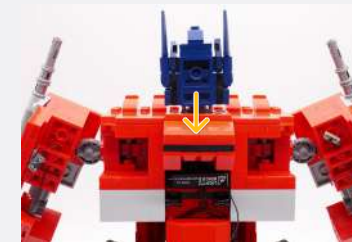

22

Legend

- DISCONNECT
- CONNECT / RECONNECT
- TURN / FLIP
- DIRECTIONAL
- TWIST / BRAID
- POWER ON TEST
- NOTE ICON

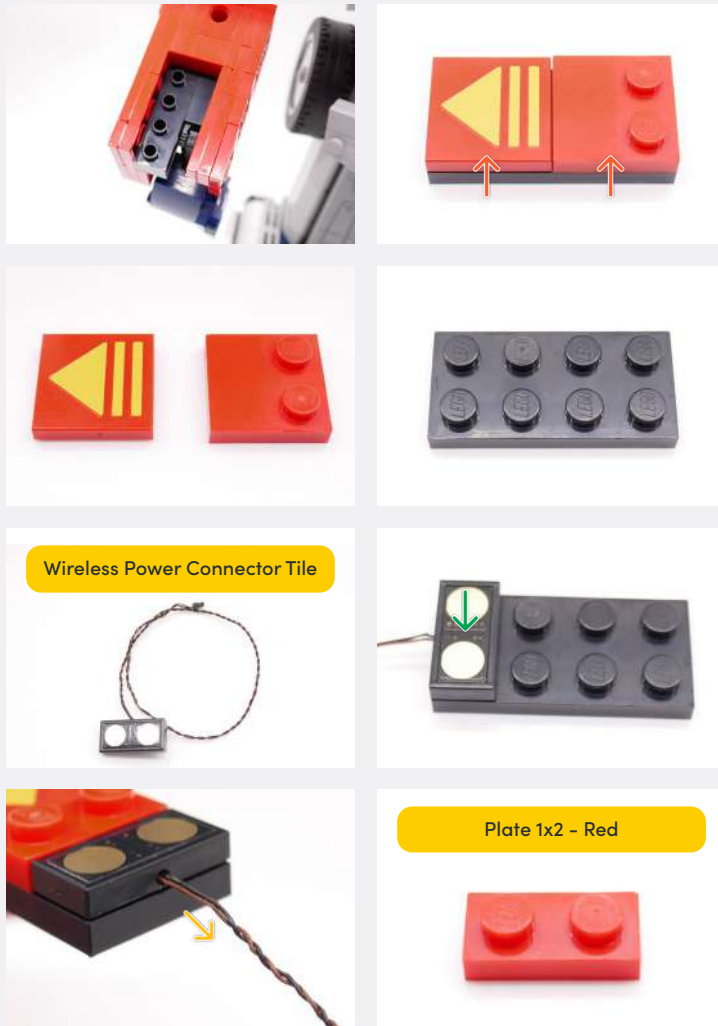

23

Rebeat step 22 for the opposite side

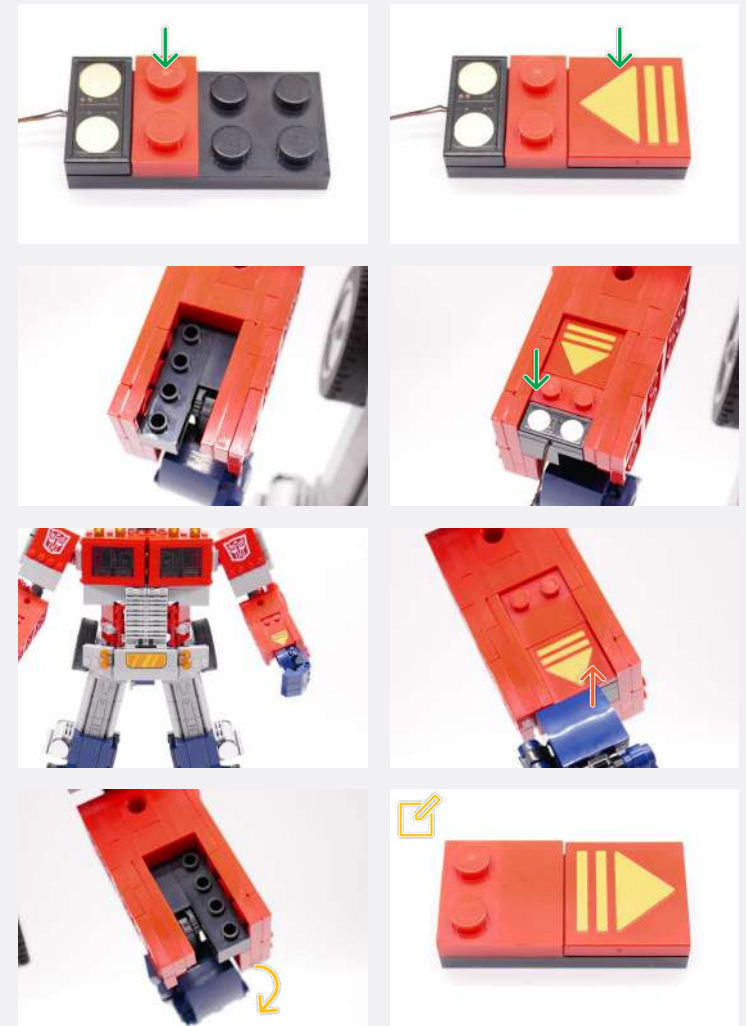

Legend → DISCONNECT → CONNECT / RECONNECT ↻ TURN / FLIP → DIRECTIONAL ↻ TWIST / BRAID * POWER ON TEST 📝 NOTE ICON

24

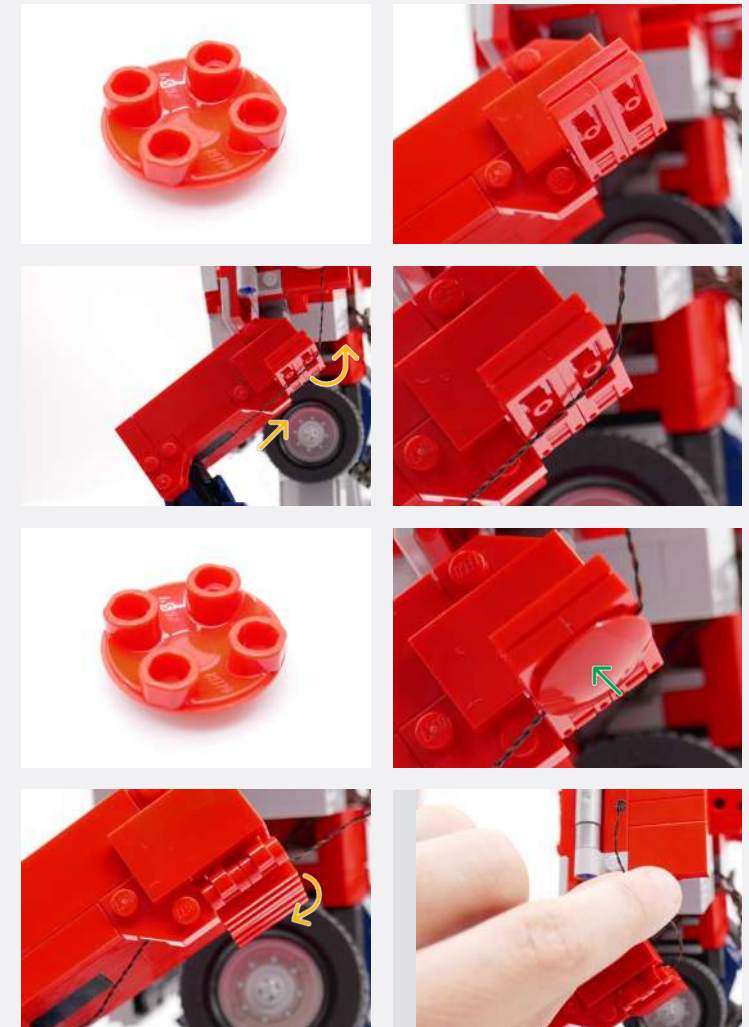

Legend → DISCONNECT → CONNECT / RECONNECT ↻ TURN / FLIP → DIRECTIONAL ↻ TWIST / BRAID * POWER ON TEST 📝 NOTE ICON

25

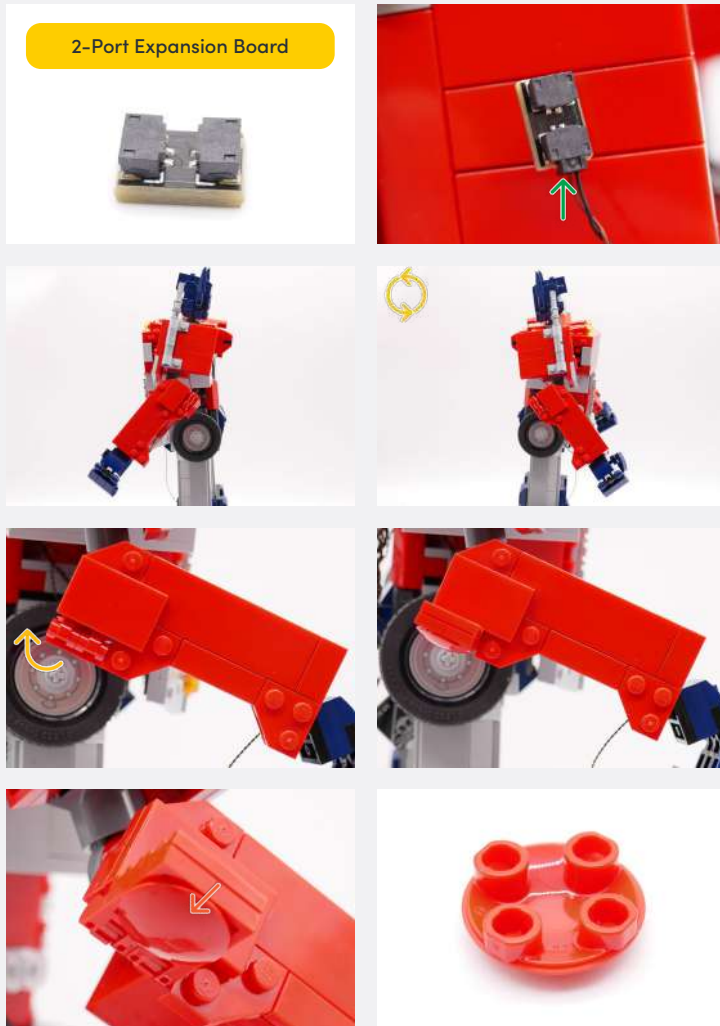

Legend → DISCONNECT → CONNECT / RECONNECT ↻ TURN / FLIP → DIRECTIONAL ↻ TWIST / BRAID ✨ POWER ON TEST 📝 NOTE ICON

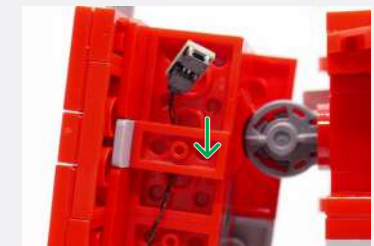
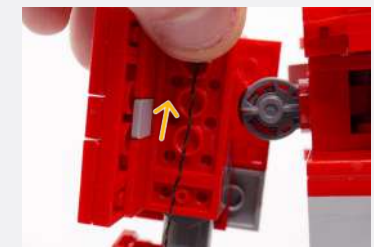
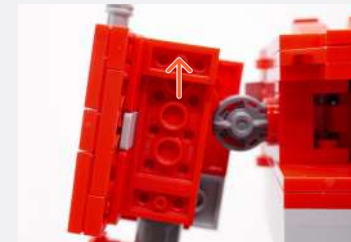
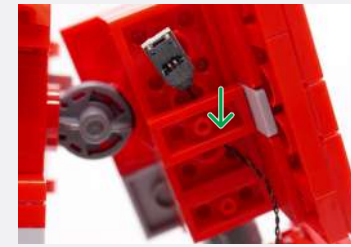
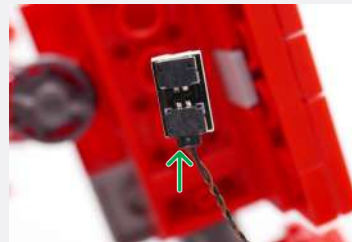

26

Legend



27

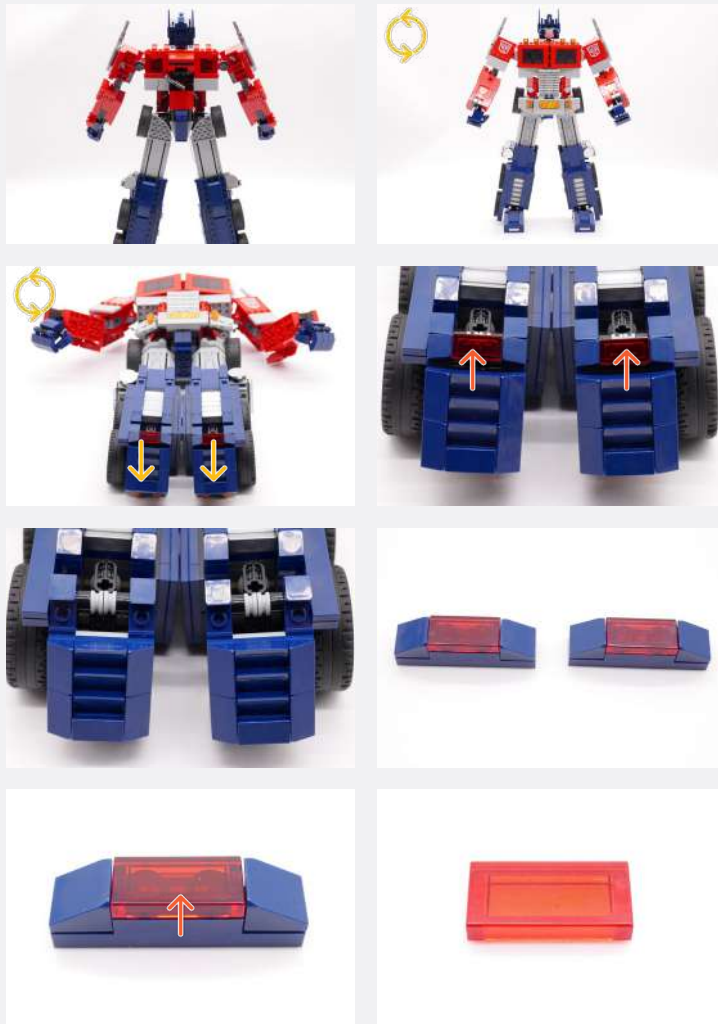

28

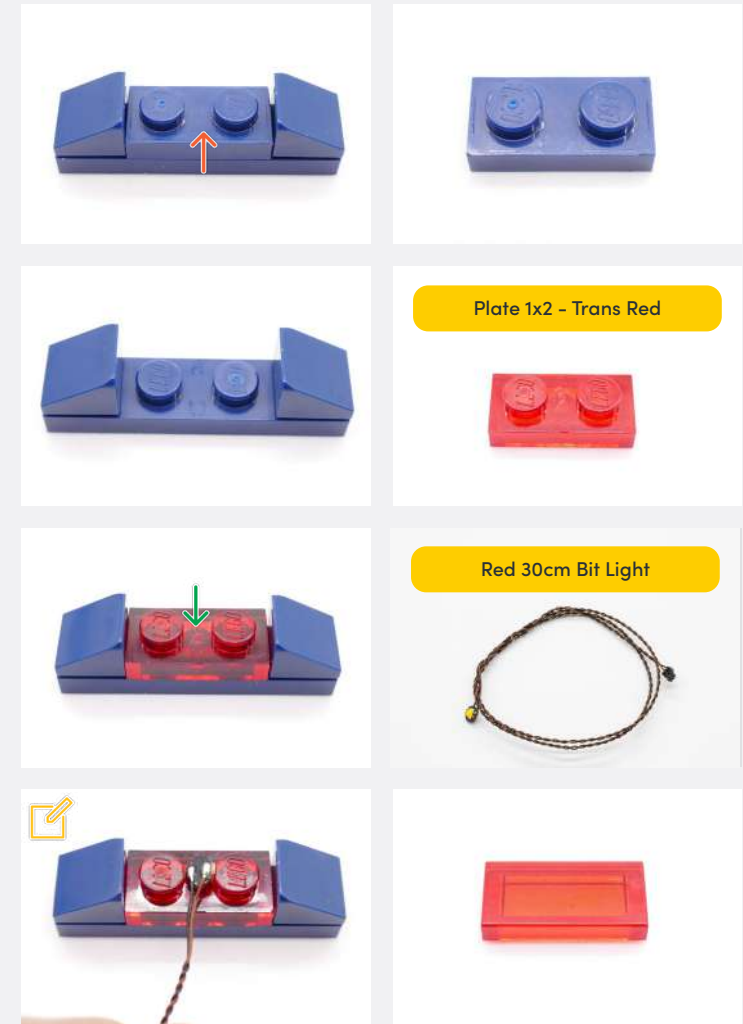
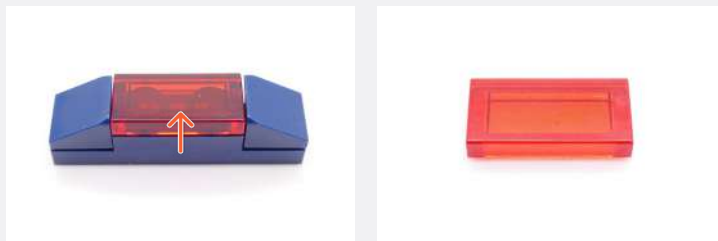

Ensure the LED is facing downwards

Legend

- DISCONNECT
- CONNECT / RECONNECT
- TURN / FLIP
- DIRECTIONAL
- TWIST / BRAID
- POWER ON TEST
- NOTE ICON

29

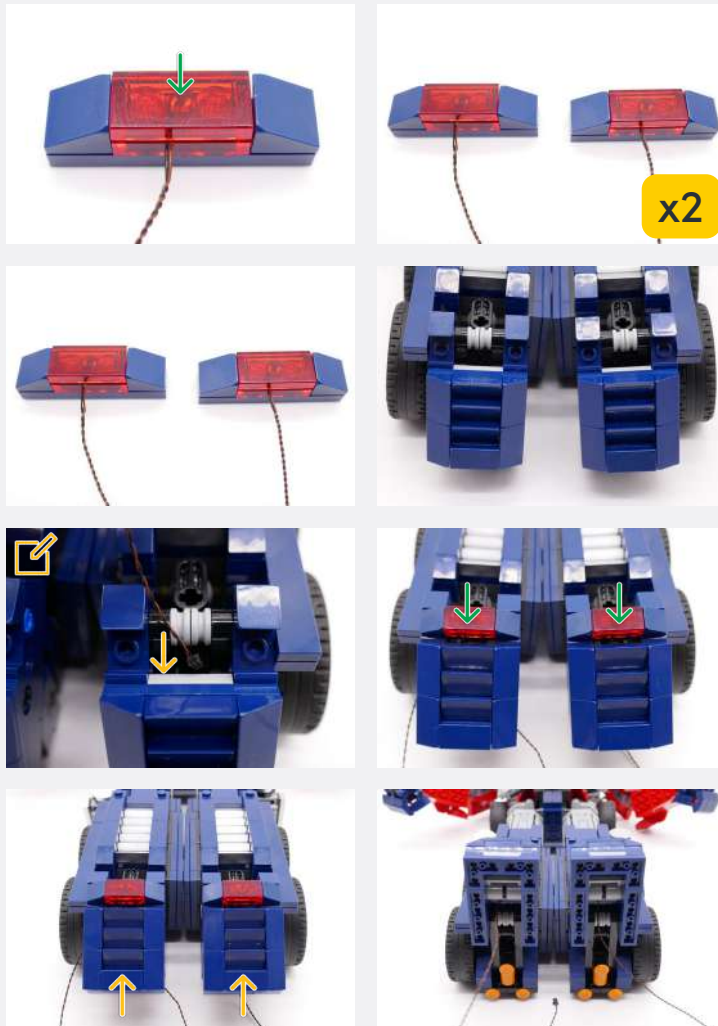

Thread the cable through for both the left and right foot

x2

30

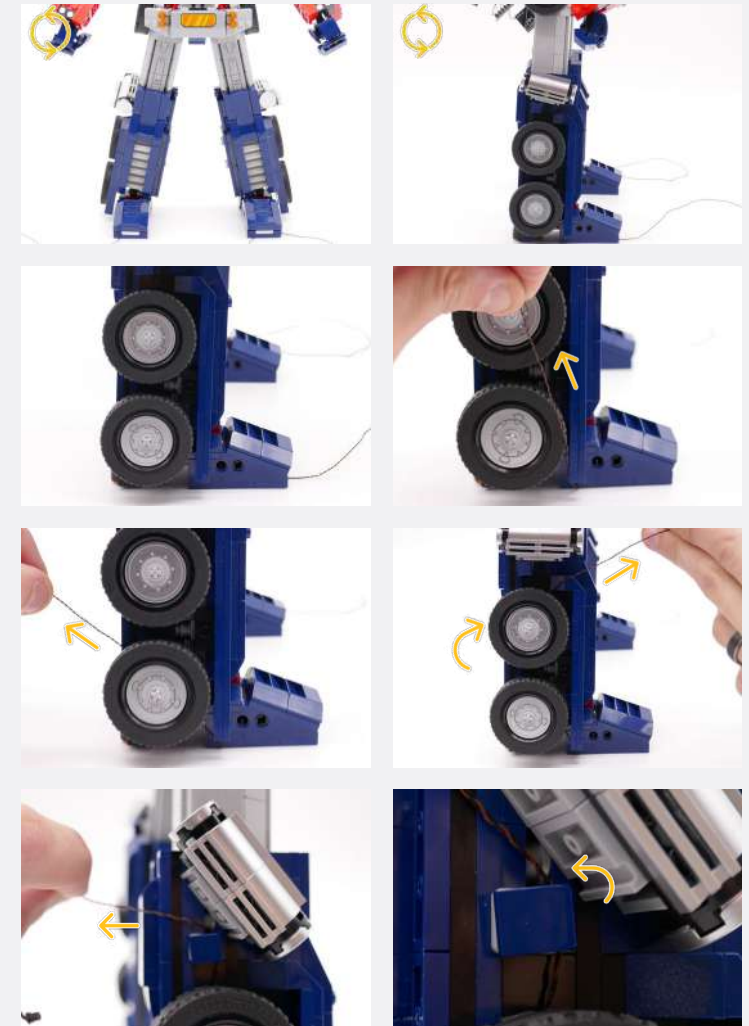

Legend

- DISCONNECT
- CONNECT / RECONNECT
- TURN / FLIP
- DIRECTIONAL
- TWIST / BRAID
- POWER ON TEST
- NOTE ICON

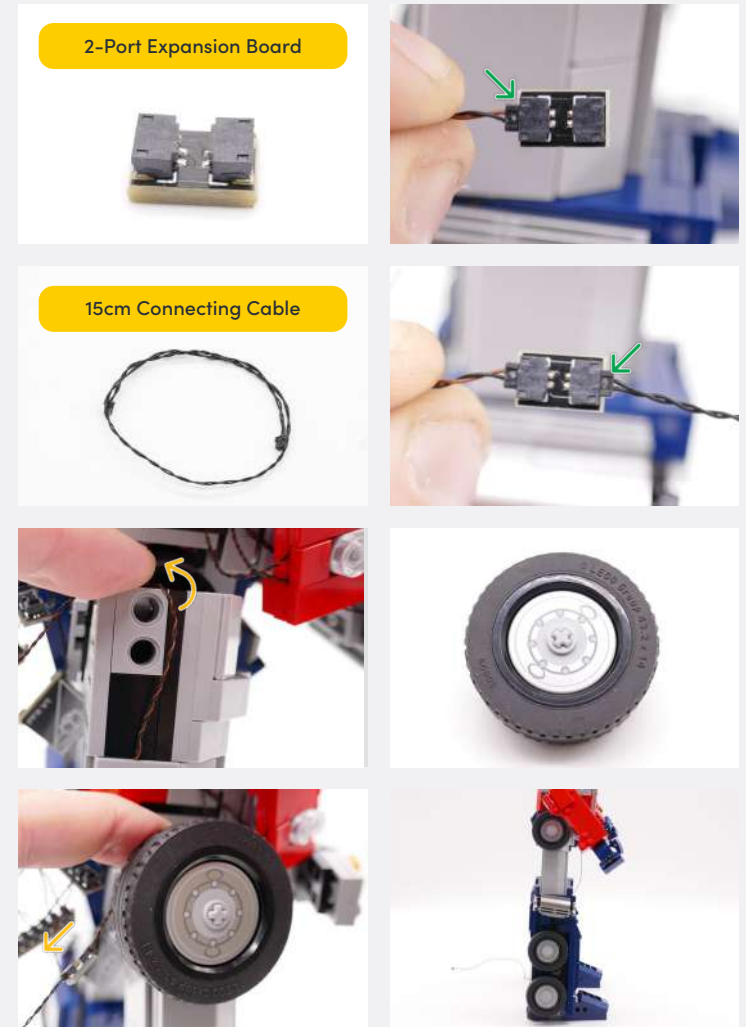

Legend → DISCONNECT → CONNECT / RECONNECT ↻ TURN / FLIP → DIRECTIONAL ↻ TWIST / BRAID ✨ POWER ON TEST 📝 NOTE ICON

30



Repeat Step 29 for the opposite side

31

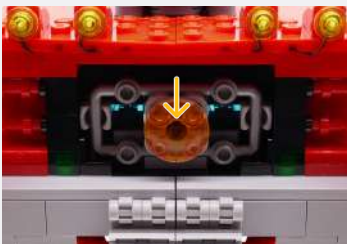

Place the LED facing up while ensuring the cable goes underneath bar



Blue 30cm Large Bit Light

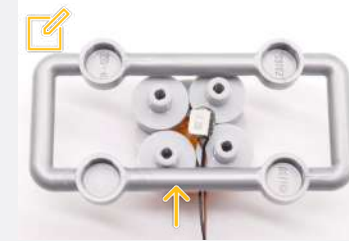
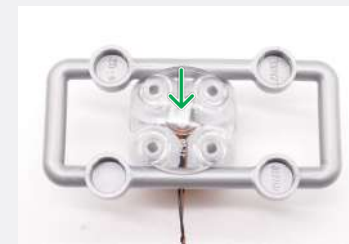

Plate 2x2 W Rounded Bottom - Trans Clear



Legend → DISCONNECT → CONNECT / RECONNECT ↻ TURN / FLIP → DIRECTIONAL ↺ TWIST / BRAID * POWER ON TEST 📝 NOTE ICON



If you have trouble reconnecting the tile, slightly disconnect the brick beneath

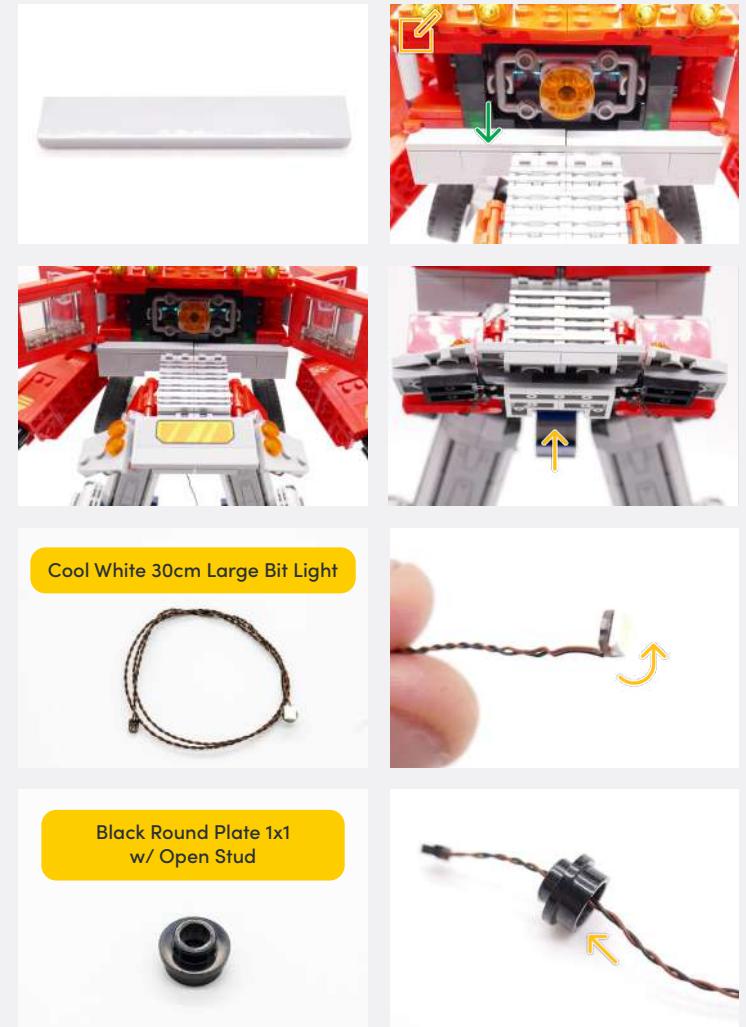

32

Cool White 30cm Large Bit Light

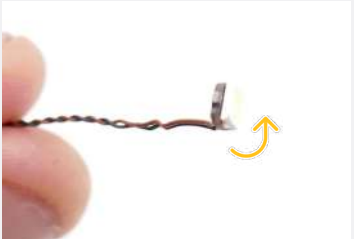

Black Round Plate 1x1 w/ Open Stud



Legend DISCONNECT CONNECT / RECONNECT TURN / FLIP DIRECTIONAL TWIST / BRAID POWER ON TEST NOTE ICON



Bracket 1x1 - Light Grey

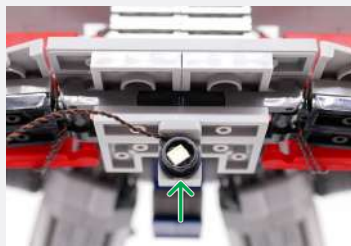

 Pull Cool White 30cm Large Bit Light from step 32 to the back from the side

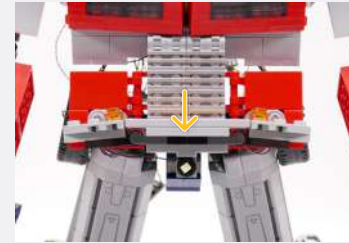

33

Legend



CONNECT / RECONNECT



DIRECTIONAL



TWIST / BRAID



POWER ON TEST



NOTE ICON

✍️ Connect the Cool White 30cm Large Bit Light to the 8-Port Expansion Board

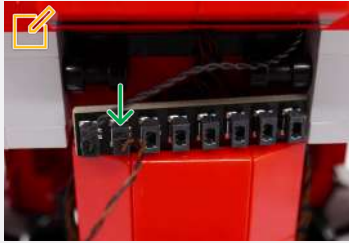

34

✍️ Connect the 15cm Connecting Cables from both the right and left leg to the 8-Port Expansion Board

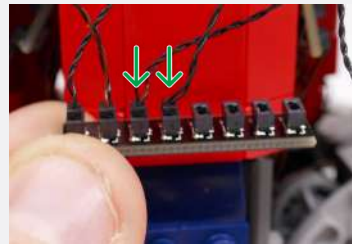
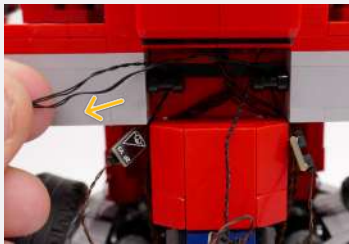

✍️ Twist the loose cables connect to the Expansion Board

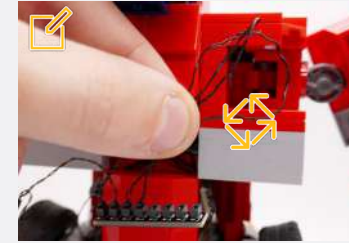

50cm Connecting Cable

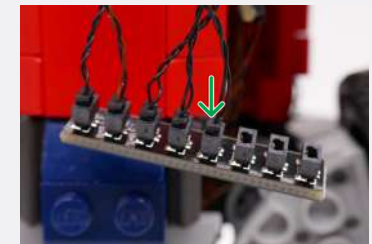

35

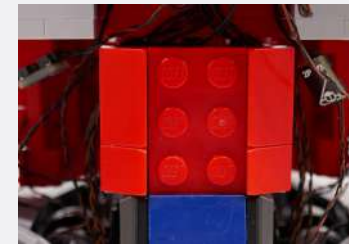
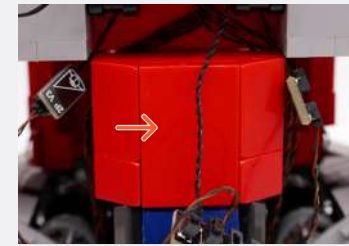

Legend

- DISCONNECT
- CONNECT / RECONNECT
- TURN / FLIP
- DIRECTIONAL
- TWIST / BRAID
- POWER ON TEST
- NOTE ICON

36

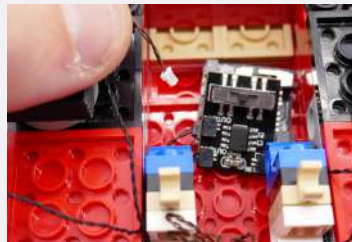
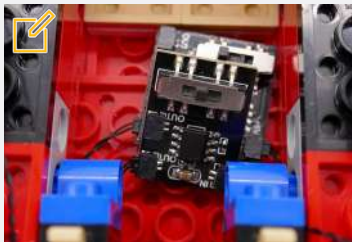
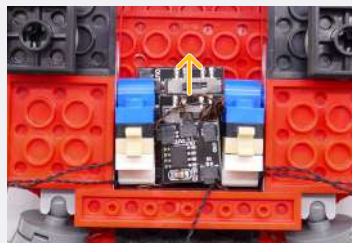
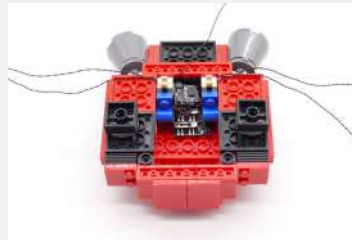
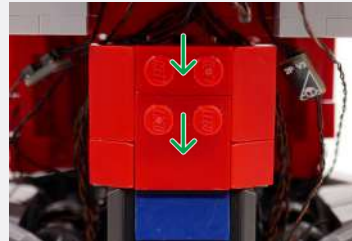

Place the jetpack on Optimus Prime's back so it is easy to connect the cables

Pull the Pulse Effects Board slightly forward

Connect the Bit Light cable from centre chest piece into the 'OUT' port of the Pulse Effect Board

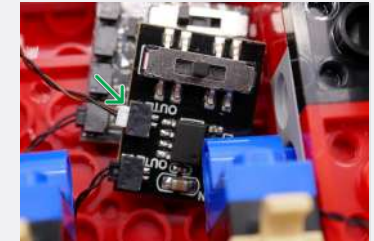
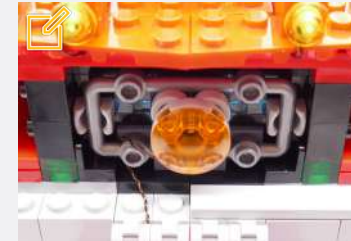

37

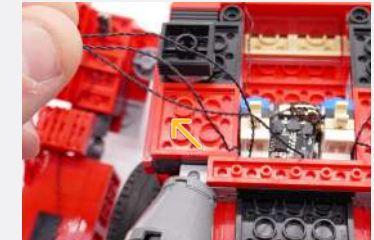
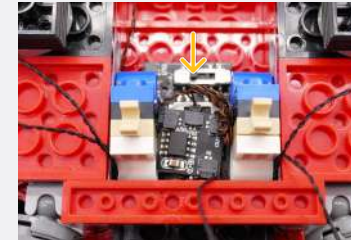

Locate the three Connecting Cables plugged into the 'IN' port of the three Effects Boards and connect them to the 8-Port Expansion Board

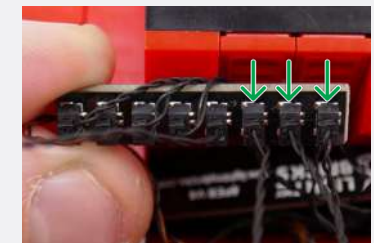
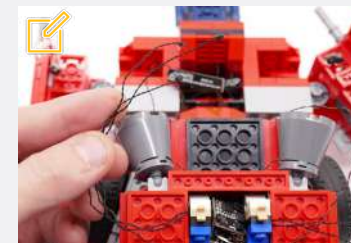

38

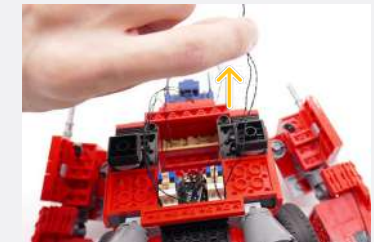

Legend

- DISCONNECT
- CONNECT / RECONNECT
- TURN / FLIP
- DIRECTIONAL
- TWIST / BRAID
- POWER ON TEST
- NOTE ICON

Connect the last two Connecting Cables coming from the 'OUT' port of Effects Boards into the 2-Port Expansion Boards on the arms

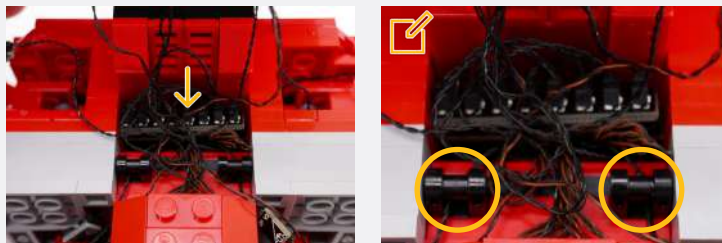
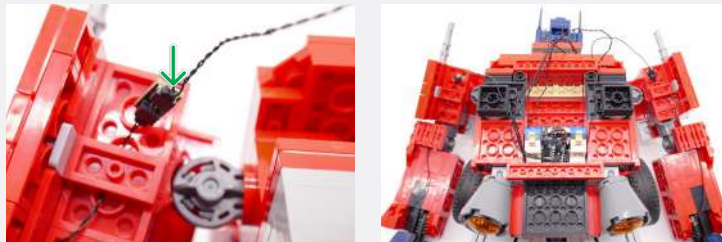
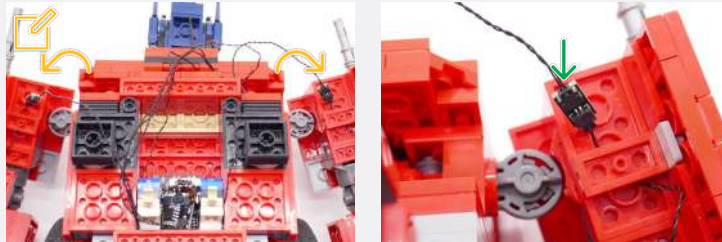

Push the cables and remaining board into the cavity - ensure no cables are in the way of clips

Make sure 50cm connecting cable is hanging down from the back before clipping on jetpack

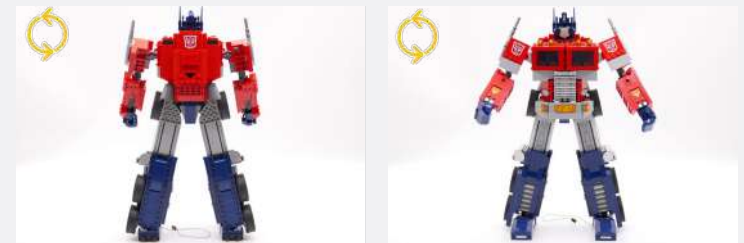
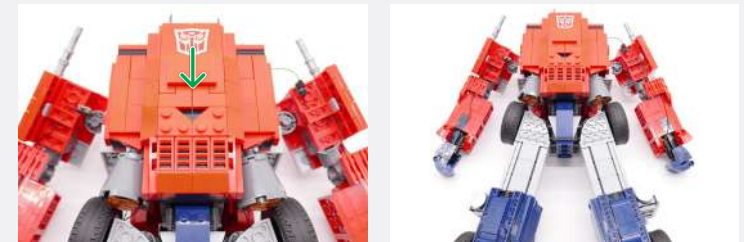
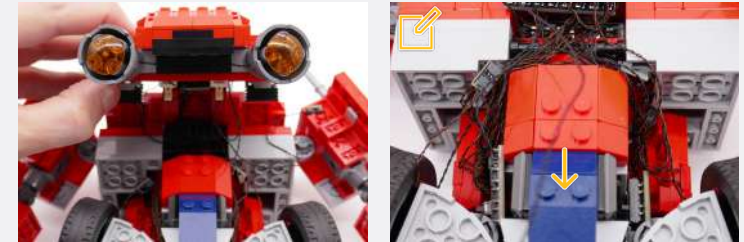

40

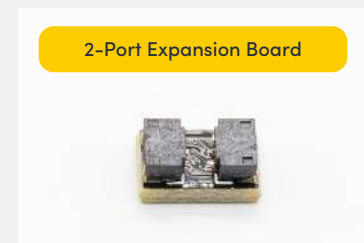

Legend → DISCONNECT → CONNECT / RECONNECT ↻ TURN / FLIP → DIRECTIONAL ↻ TWIST / BRAID * POWER ON TEST 📌 NOTE ICON

Connect 50cm connecting cable and USB power cable to 2-port expansion board



Connect the other end to a USB Power Bank/power source

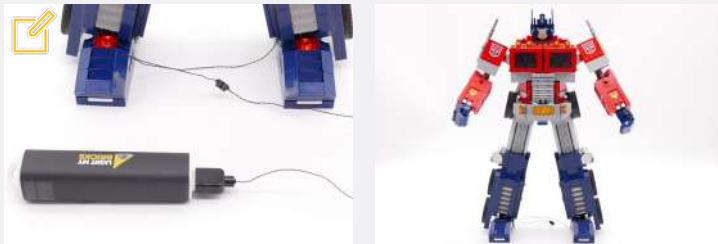

Legend DISCONNECT CONNECT / RECONNECT TURN / FLIP DIRECTIONAL TWIST / BRAID POWER ON TEST NOTE ICON

41

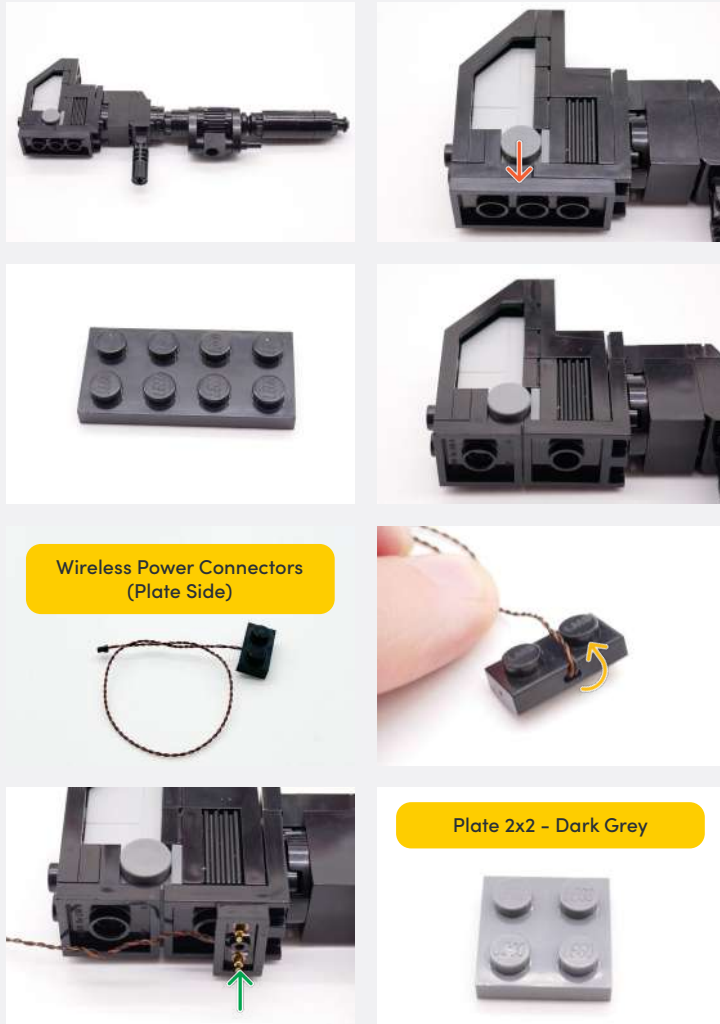

Legend → DISCONNECT → CONNECT / RECONNECT ↻ TURN / FLIP → DIRECTIONAL ↺ TWIST / BRAID ✨ POWER ON TEST 📝 NOTE ICON

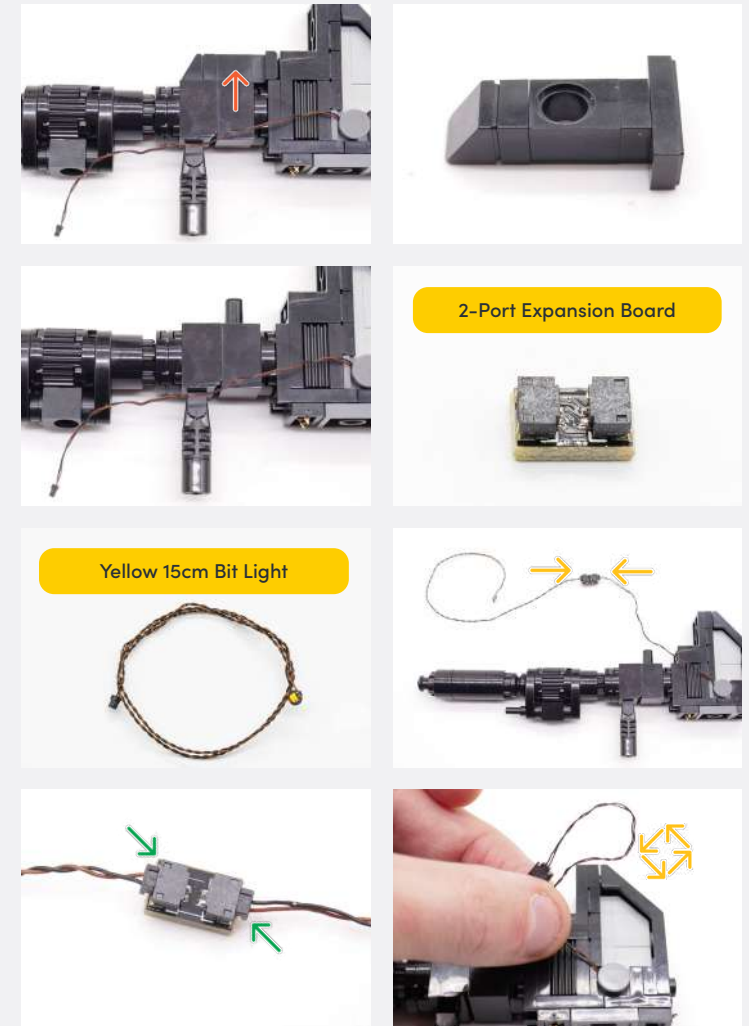
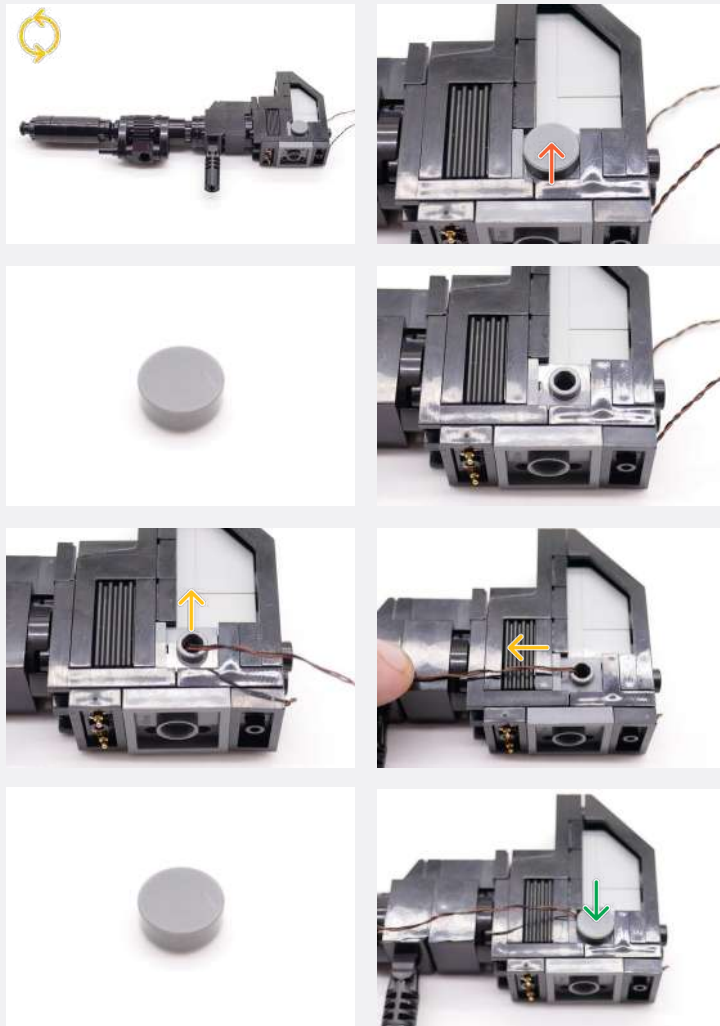

Legend

- DISCONNECT
- CONNECT / RECONNECT
- TURN / FLIP
- DIRECTIONAL
- TWIST / BRAID
- POWER ON TEST
- NOTE ICON

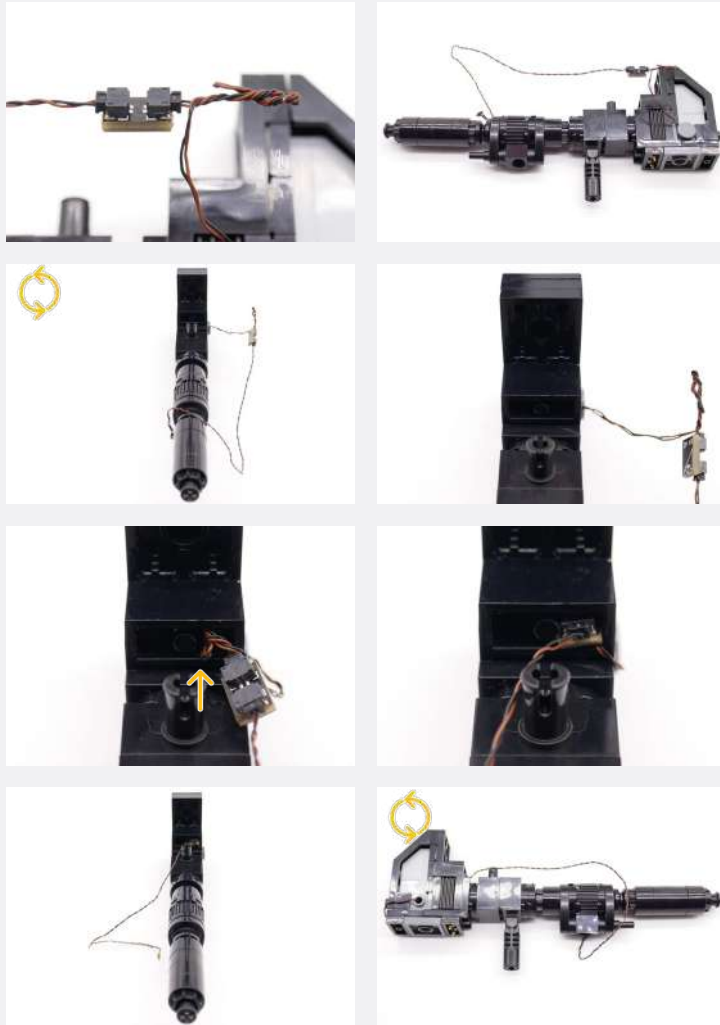

42



Legend → DISCONNECT → CONNECT / RECONNECT ↻ TURN / FLIP → DIRECTIONAL ↻ TWIST / BRAID * POWER ON TEST 📝 NOTE ICON



Legend

- DISCONNECT
- CONNECT / RECONNECT
- TURN / FLIP
- DIRECTIONAL
- TWIST / BRAID
- POWER ON TEST
- NOTE ICON

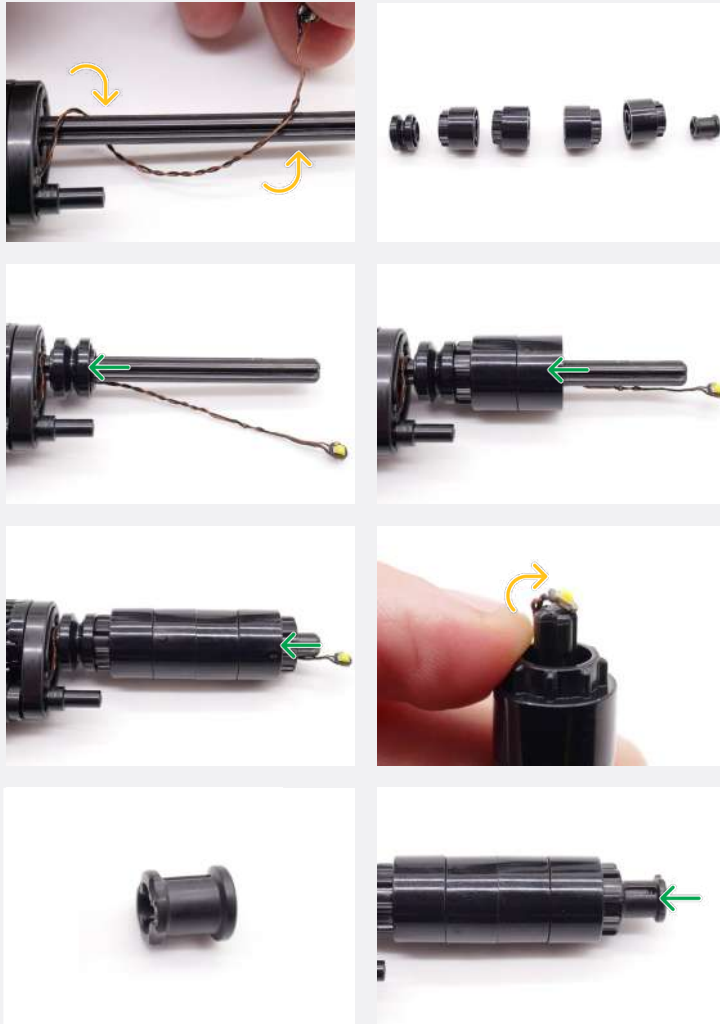

43



Legend → DISCONNECT → CONNECT / RECONNECT ↻ TURN / FLIP → DIRECTIONAL ↻ TWIST / BRAID * POWER ON TEST 📝 NOTE ICON

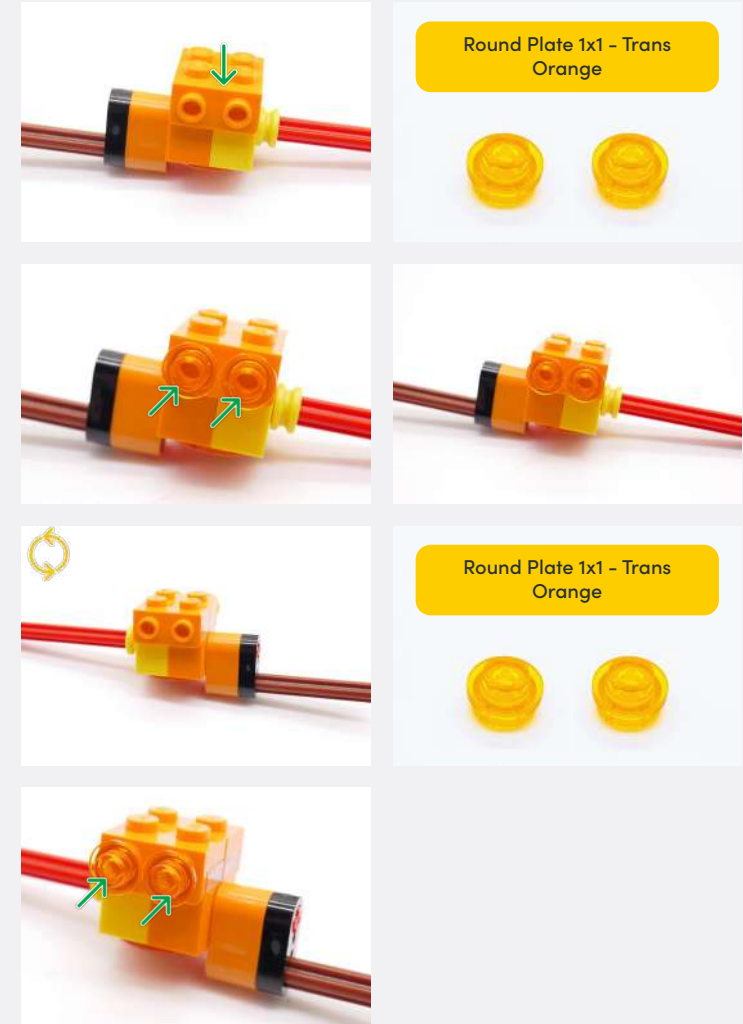
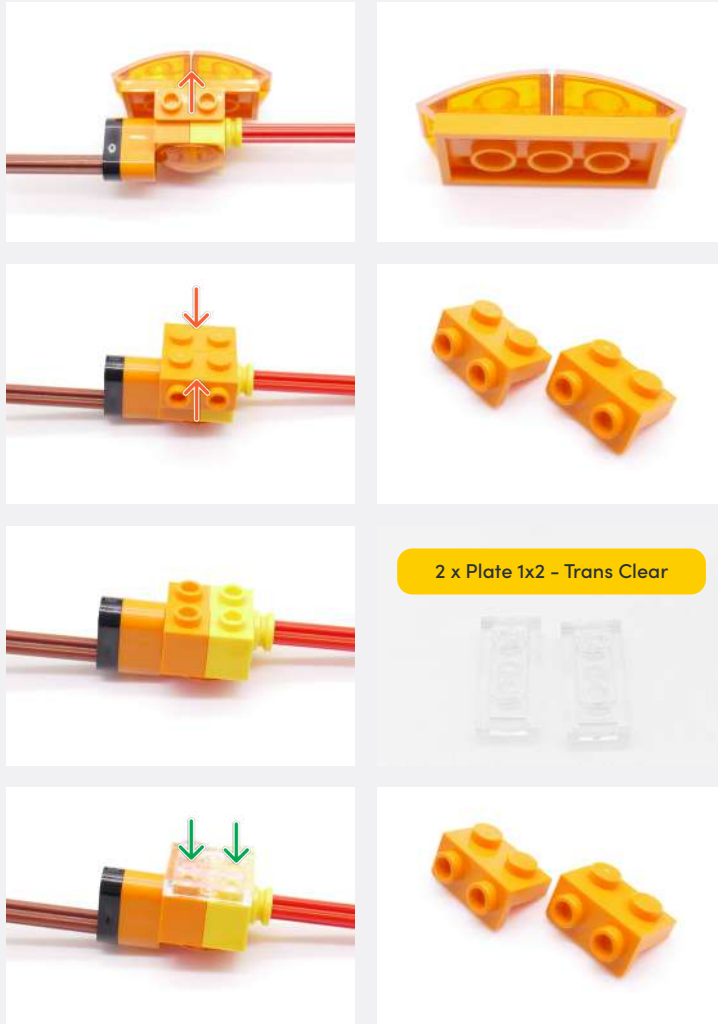

Legend → DISCONNECT → CONNECT / RECONNECT ↻ TURN / FLIP → DIRECTIONAL ↻ TWIST / BRAID ✨ POWER ON TEST 📝 NOTE ICON

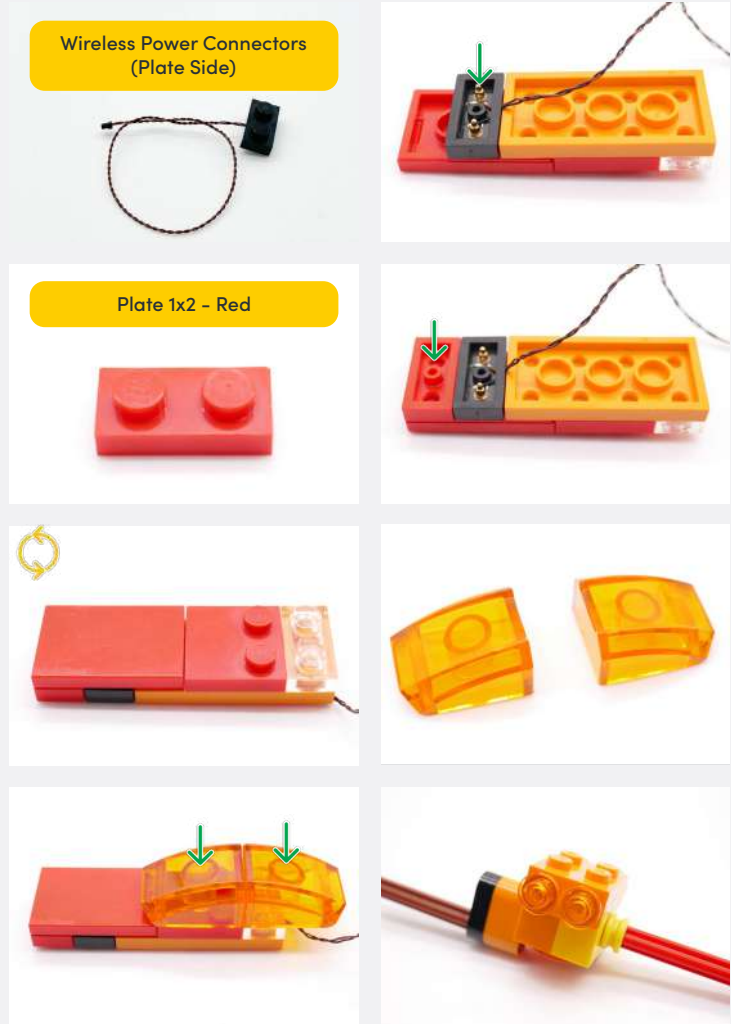
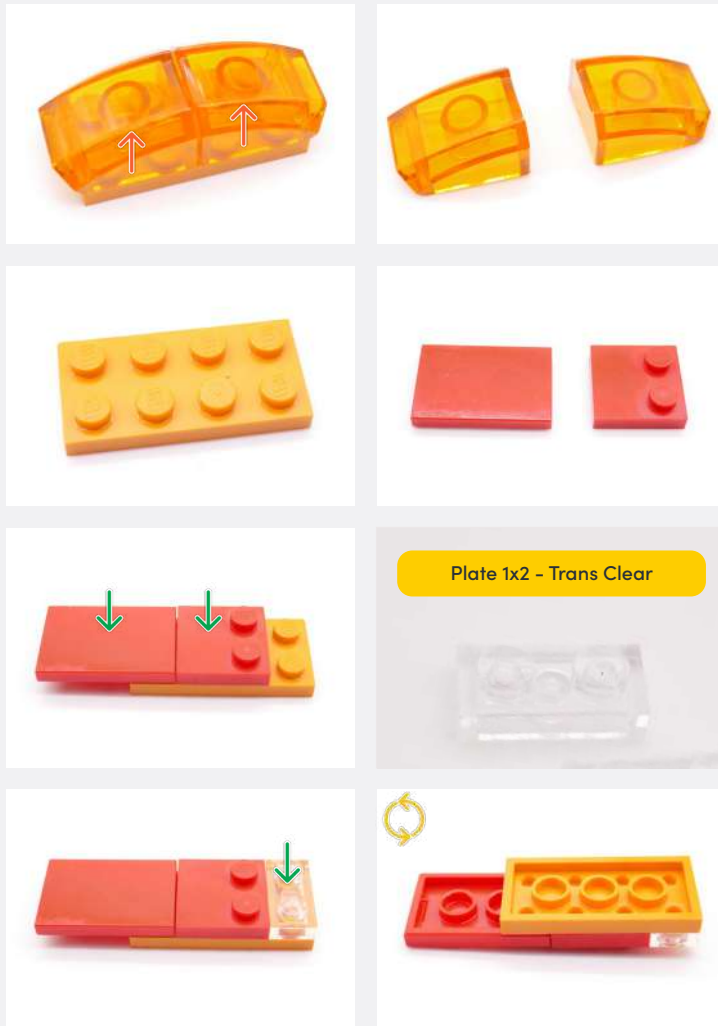

Legend → DISCONNECT → CONNECT / RECONNECT ↻ TURN / FLIP → DIRECTIONAL ↻ TWIST / BRAID * POWER ON TEST 📝 NOTE ICON

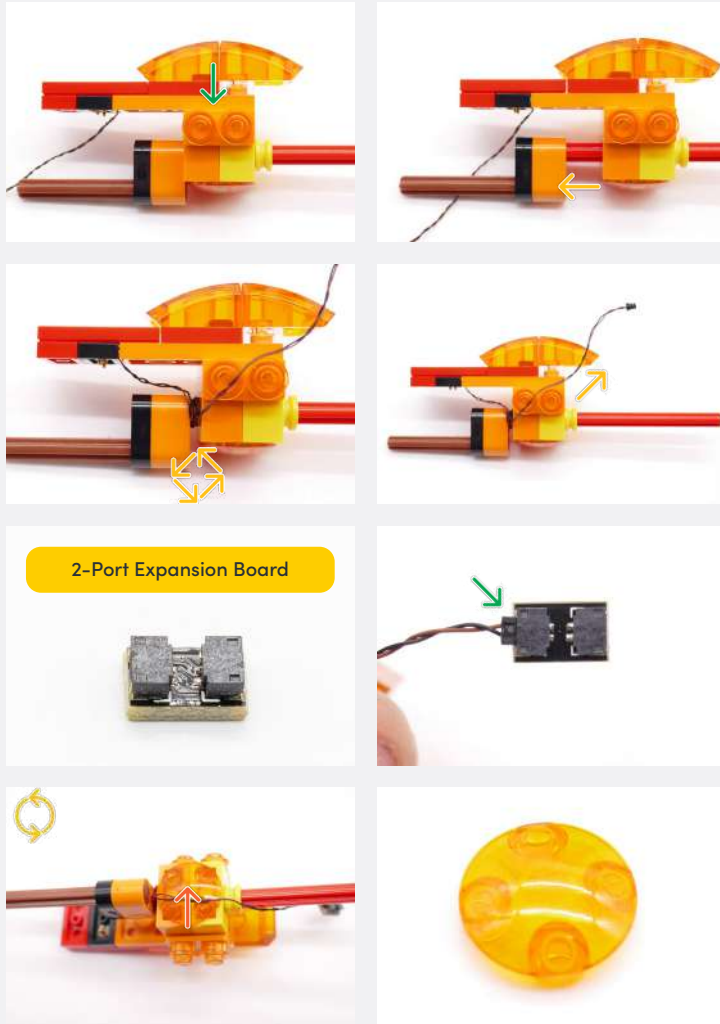

2-Port Expansion Board

44

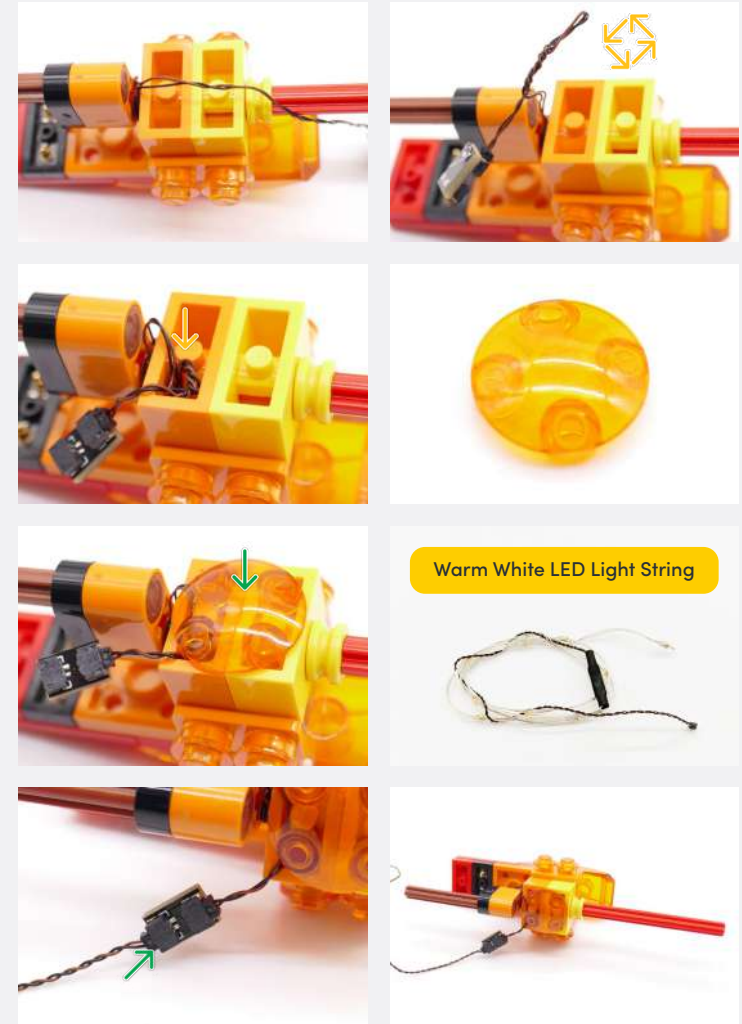

Warm White LED Light String

Legend → DISCONNECT → CONNECT / RECONNECT ↻ TURN / FLIP → DIRECTIONAL ↻ TWIST / BRAID * POWER ON TEST 📝 NOTE ICON

✂ Twist Light String wire (only wire) around Red Technic Axle as shown

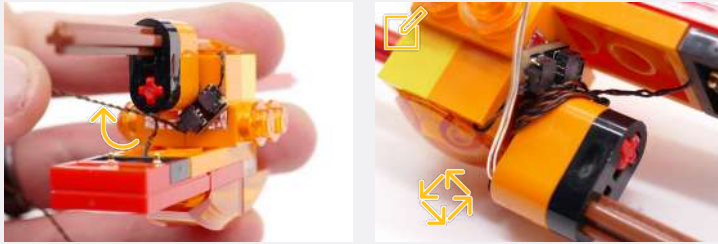

✂ Wrap the cable around the Orange Round Plate - 1x1

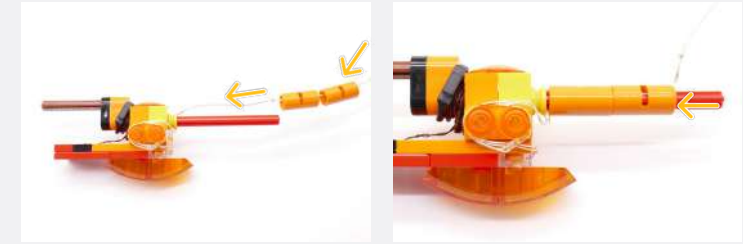
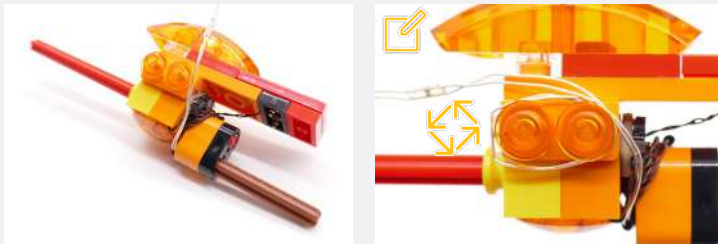

✂ Remove the panel from both sides



Legend → DISCONNECT → CONNECT / RECONNECT ↻ TURN / FLIP → DIRECTIONAL ↻ TWIST / BRAID * POWER ON TEST ✂ NOTE ICON

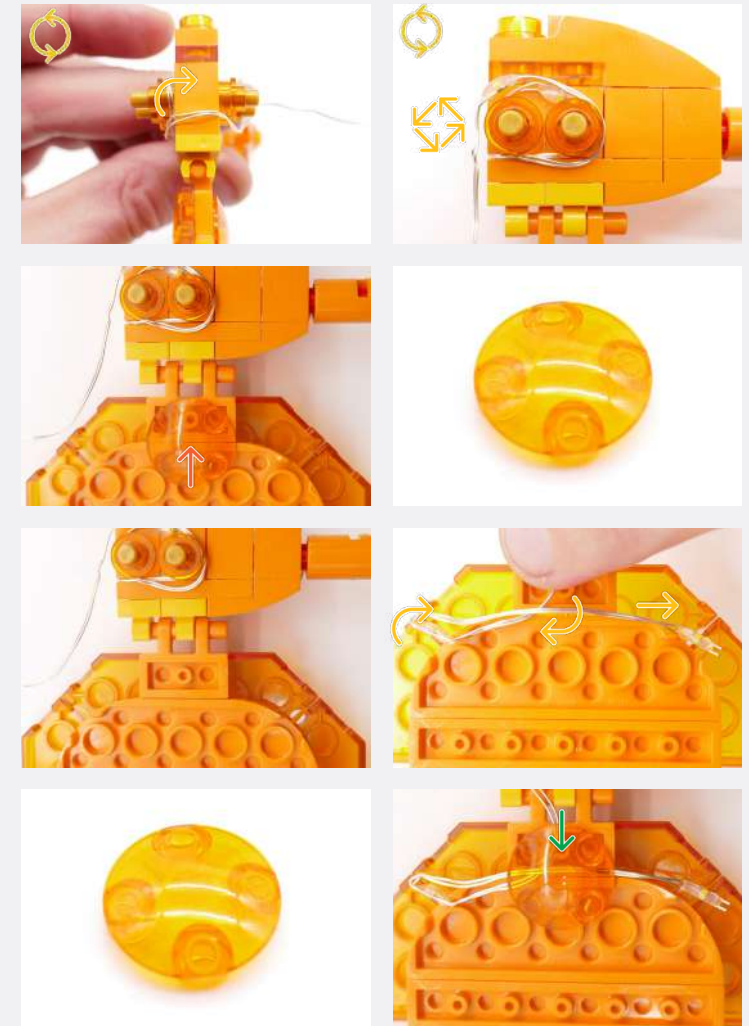

Legend

- DISCONNECT
- CONNECT / RECONNECT
- TURN / FLIP
- DIRECTIONAL
- TWIST / BRAID
- POWER ON TEST
- NOTE ICON

✍ Reconnect the panel piece on both sides



45

✍ Depending on which way you've wired the arms, you may need to swap the weapons around

The gun should have the Gun Effects

The axe should have the Pulse Effects

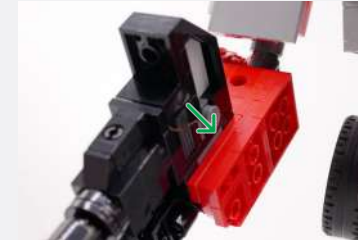
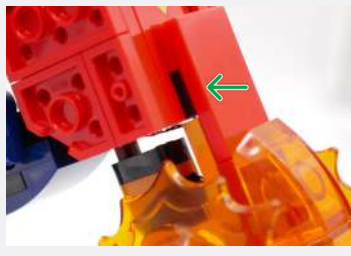

Legend → DISCONNECT → CONNECT / RECONNECT ↻ TURN / FLIP → DIRECTIONAL ↔ TWIST / BRAID ✨ POWER ON TEST ✍ NOTE ICON



TRUCK MODE INSTRUCTIONS

Light Kit Guide for installation into
Truck Mode.

If you intend to display your Optimus
Prime 10302 in Truck form, follow the
instructions below.



1

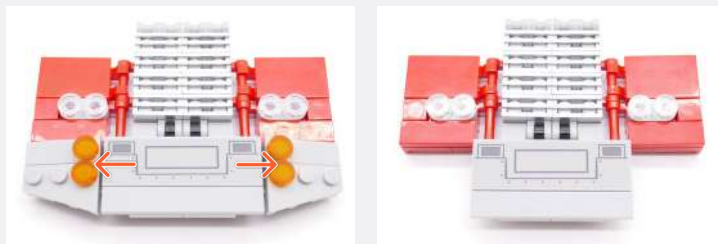

2

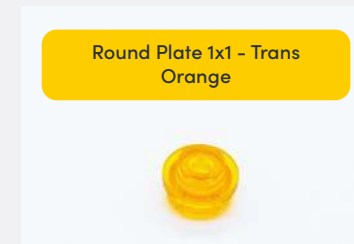

Legend → DISCONNECT → CONNECT / RECONNECT ↻ TURN / FLIP → DIRECTIONAL ↻ TWIST / BRAID ✨ POWER ON TEST 📝 NOTE ICON

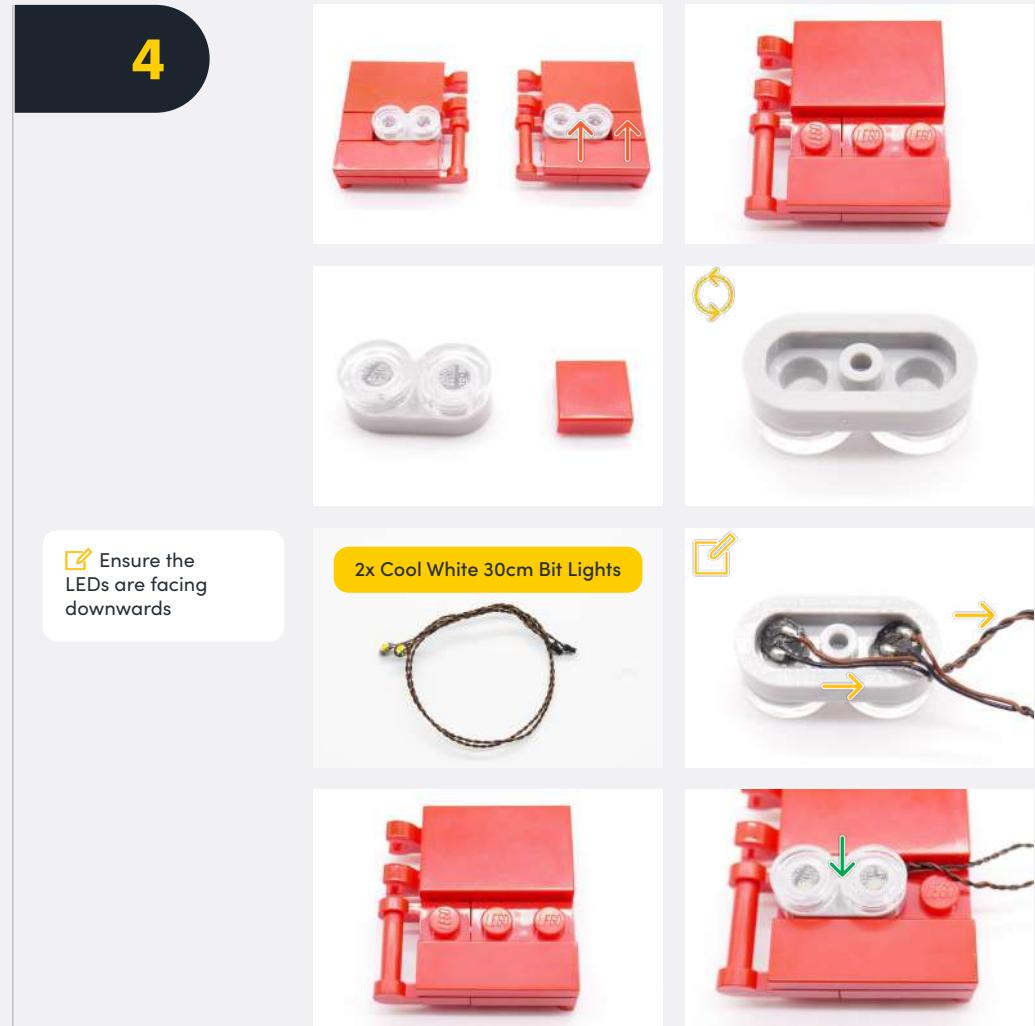
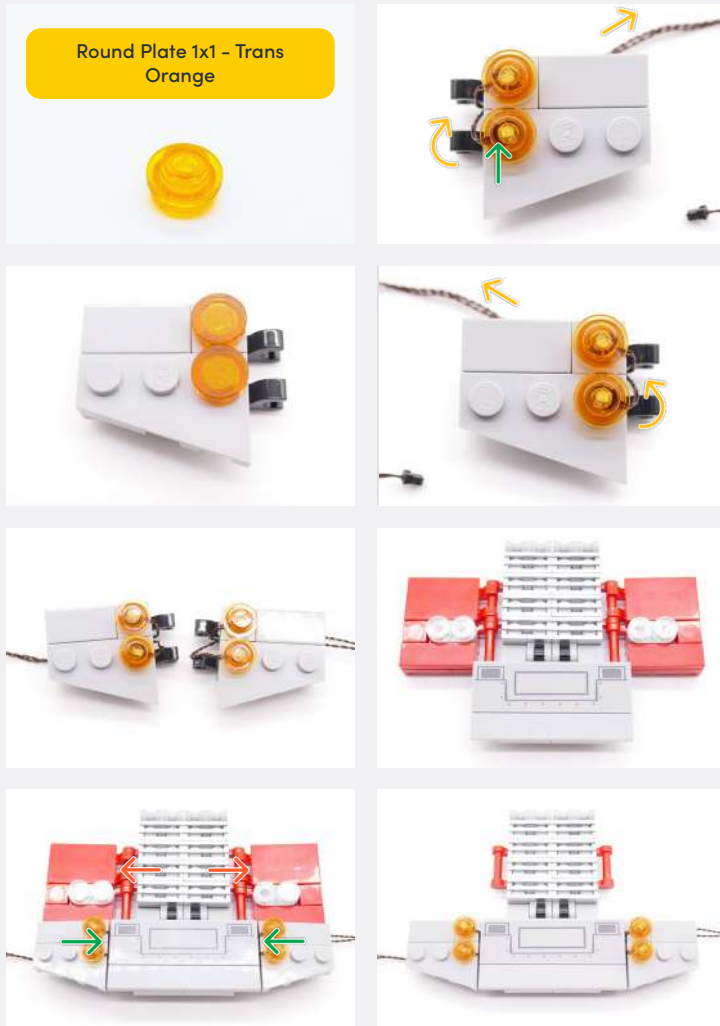

Legend

- DISCONNECT
- CONNECT / RECONNECT
- ↻ TURN / FLIP
- DIRECTIONAL
- ↻↻ TWIST / BRAID
- ✳ POWER ON TEST
- 📝 NOTE ICON

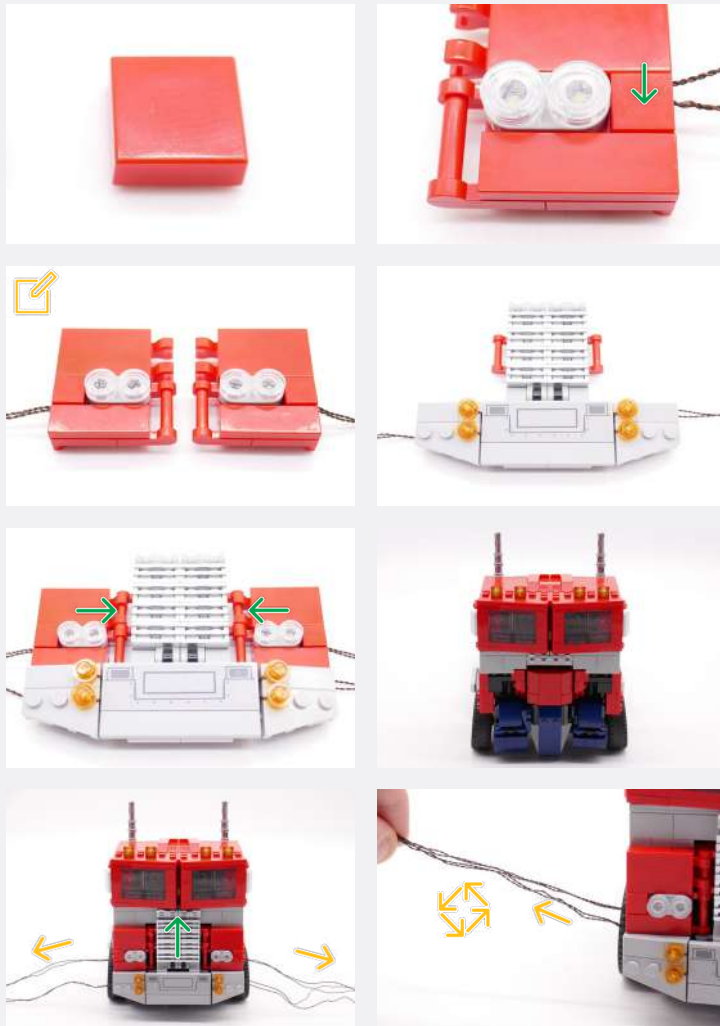

Repeat this step for the opposite side

5



Legend → DISCONNECT → CONNECT / RECONNECT ↻ TURN / FLIP → DIRECTIONAL ↻ TWIST / BRAID ✨ POWER ON TEST 📝 NOTE ICON

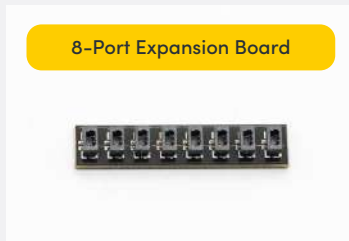
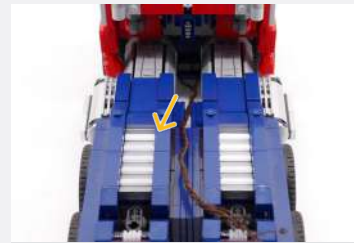

8-Port Expansion Board

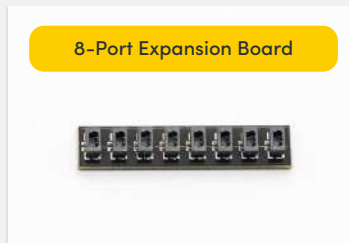
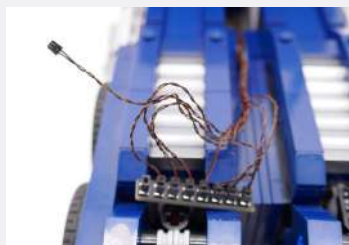
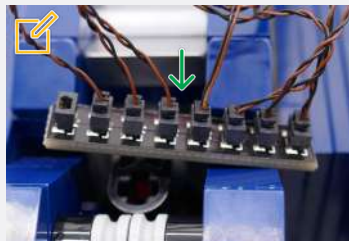

8-Port Expansion Board



5cm Connecting Cable

✂ Connect Seven of the Eight Bit Lights to the 8-Port Expansion Board

6

7

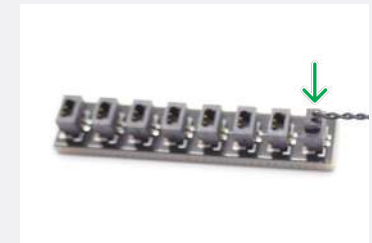

✂ Connect the other end of the 5cm Connecting Cable to the other 8-Port Expansion Board, while connecting the remaining Bit Light to any empty port

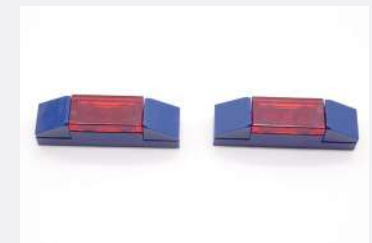
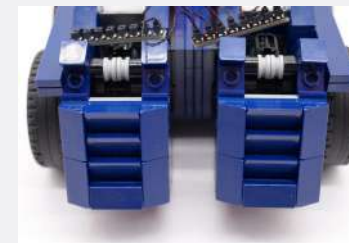
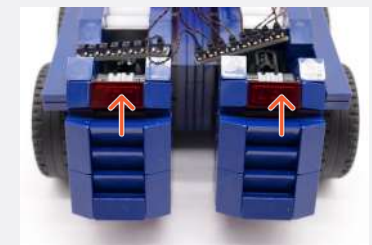
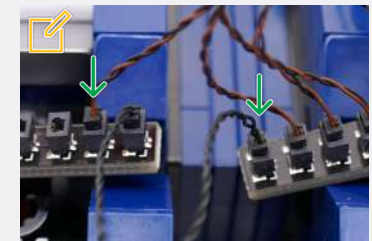

Legend → DISCONNECT → CONNECT / RECONNECT ↻ TURN / FLIP → DIRECTIONAL ↻ TWIST / BRAID * POWER ON TEST 📝 NOTE ICON

8

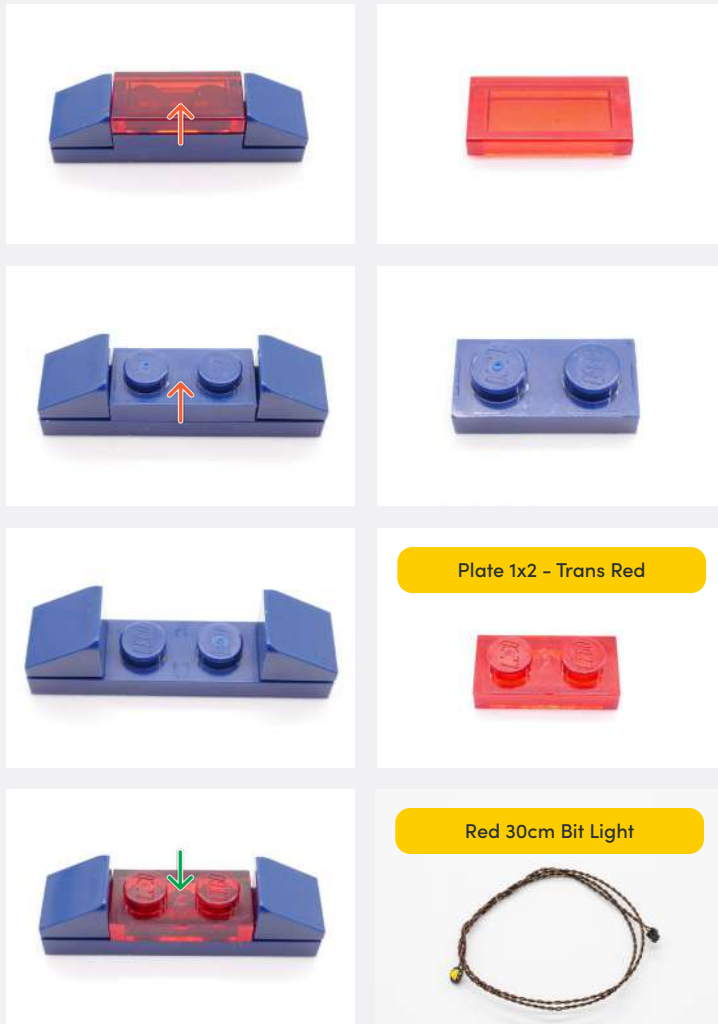

Ensure the LED is facing downwards

9

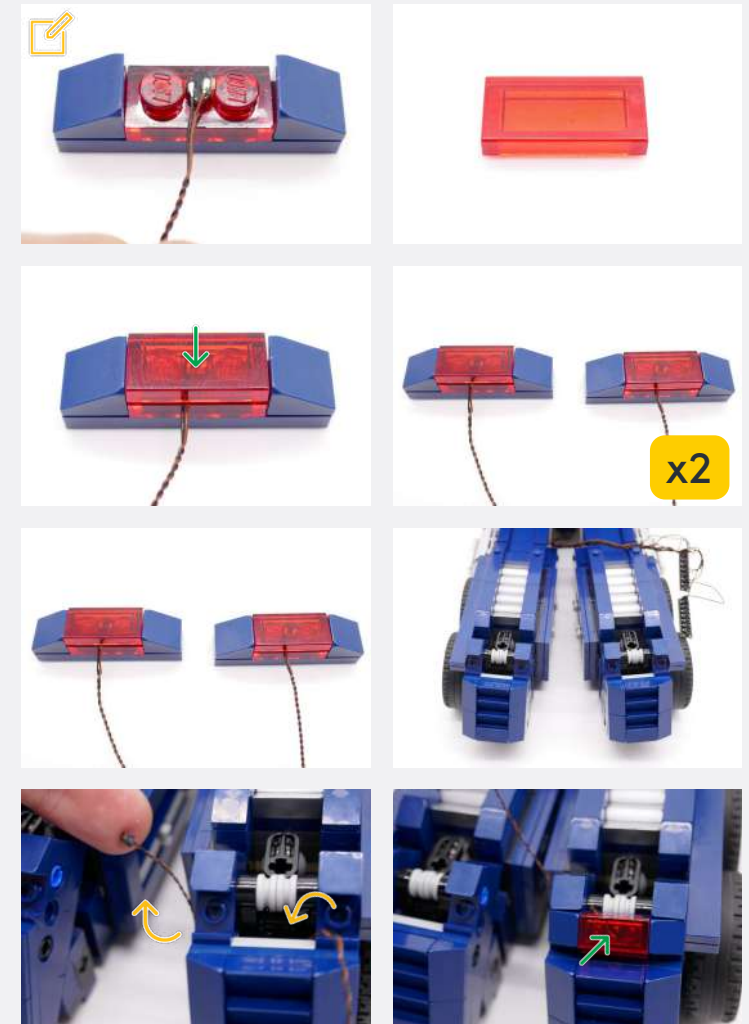

Legend

- DISCONNECT
- CONNECT / RECONNECT
- ↻ TURN / FLIP
- DIRECTIONAL
- ↻ TWIST / BRAID
- ✳ POWER ON TEST
- 📌 NOTE ICON

10

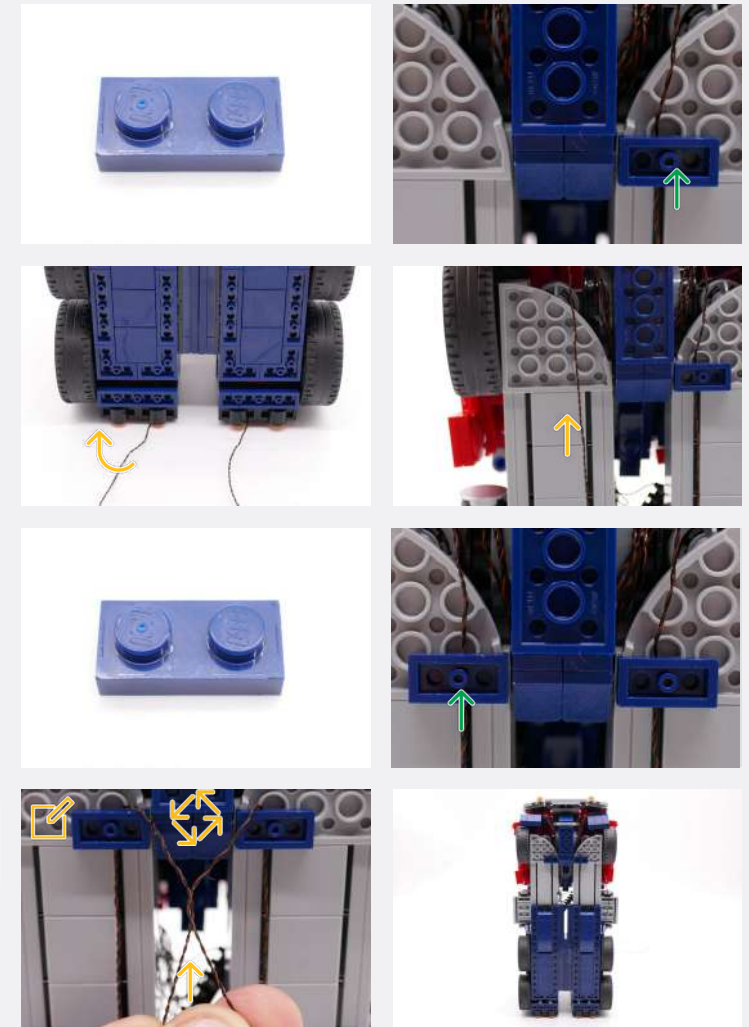
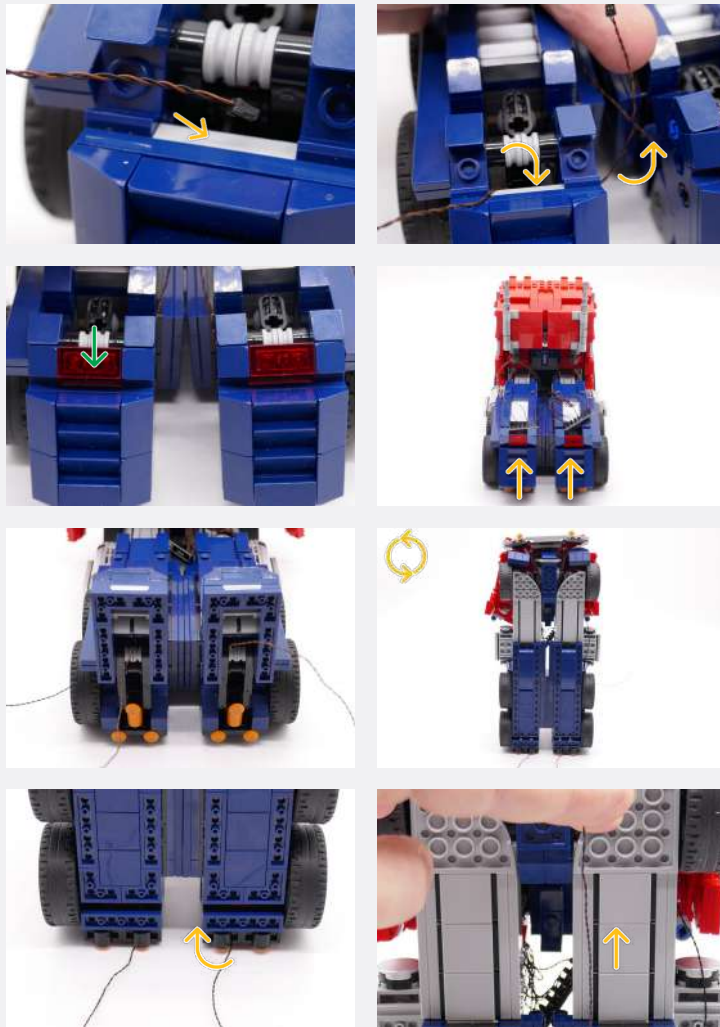

Ensure to thread the cables through the gap as indicated

Legend → DISCONNECT → CONNECT / RECONNECT ↻ TURN / FLIP → DIRECTIONAL ↻ TWIST / BRAID * POWER ON TEST 📝 NOTE ICON

11

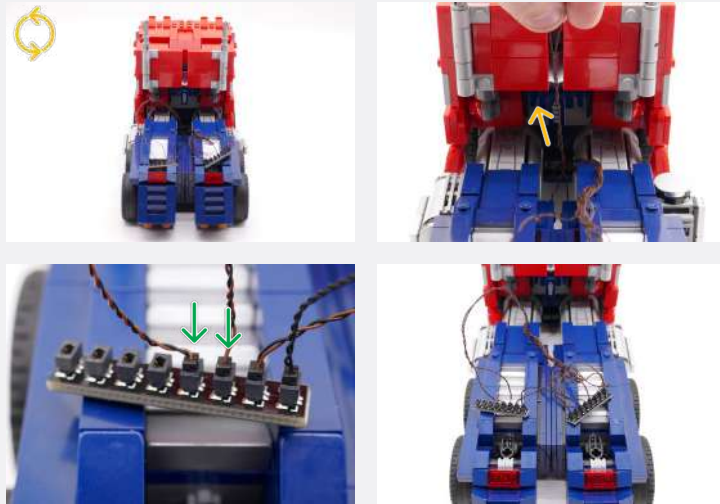

12



13

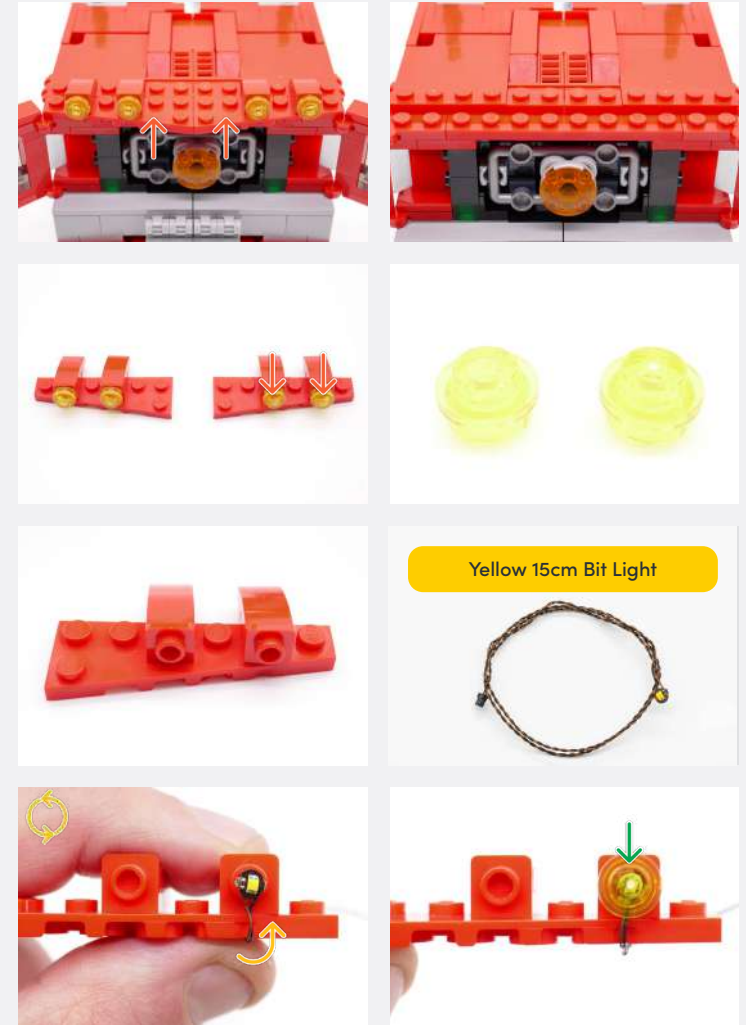

Legend

- DISCONNECT
- CONNECT / RECONNECT
- TURN / FLIP
- DIRECTIONAL
- TWIST / BRAID
- POWER ON TEST
- NOTE ICON



Yellow 15cm Bit Light

Repeat this step for the opposite side

14



Legend

- DISCONNECT
- CONNECT / RECONNECT
- ↻ TURN / FLIP
- DIRECTIONAL
- ↔ TWIST / BRAID
- ✳ POWER ON TEST
- 📌 NOTE ICON

15

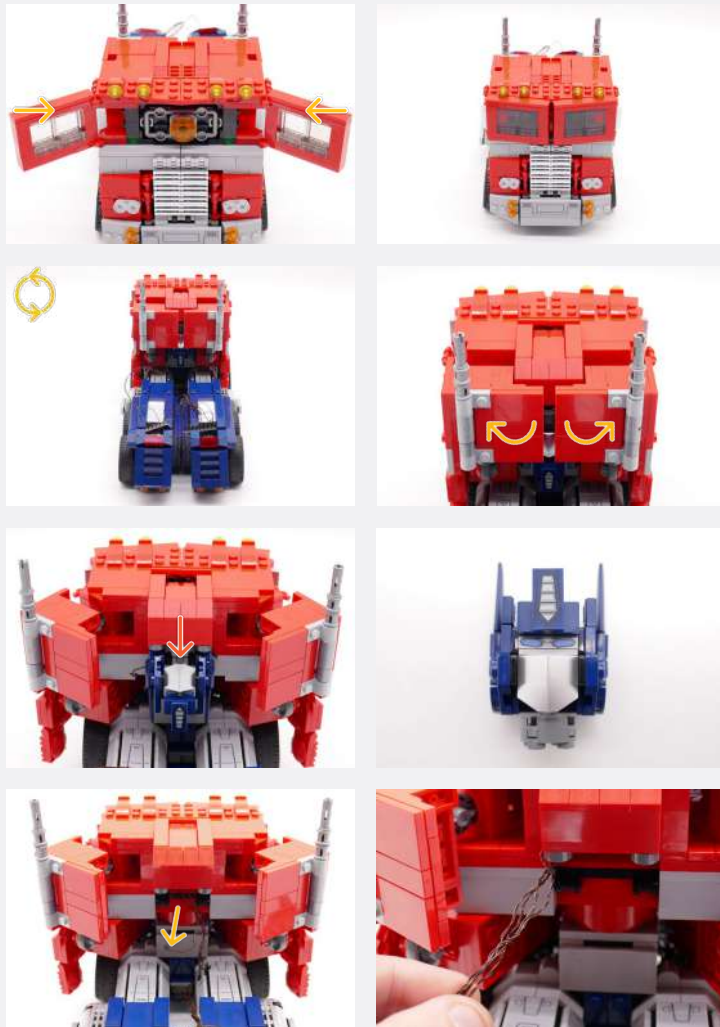

✍ Connect the other end of the 5cm Connecting Cable to the 8-Port Expansion Board from Step 11

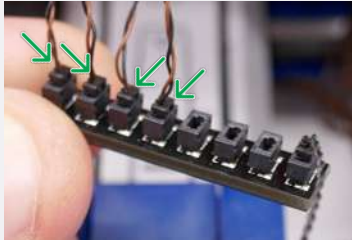
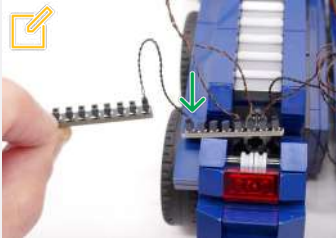

Legend → DISCONNECT → CONNECT / RECONNECT ↻ TURN / FLIP → DIRECTIONAL ↻ TWIST / BRAID ✨ POWER ON TEST ✍ NOTE ICON

16

2-Port Expansion Board



50cm Connecting Cable



USB Power Cable

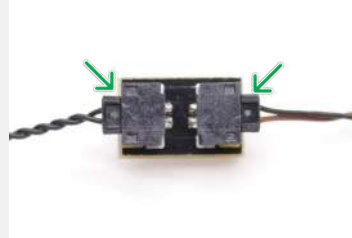

✂ Connect the 50cm Connecting Cable to this 8-Port Expansion Board

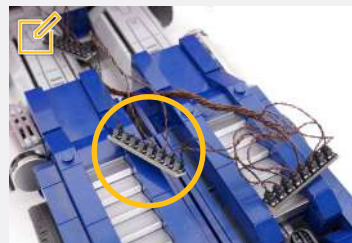

✂ Connect to a power source - 5V USB Power Bank, 5V USB Wall Adaptor, or USB to AA Battery Pack (sold separately)

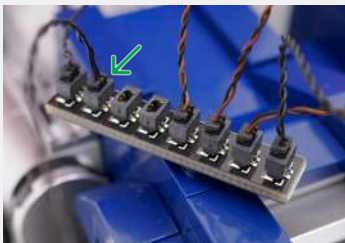

17

✂ Insert the first 8-Port Expansion Board into the cavity



✂ Insert the second 8-Port Expansion Board into the same cavity. Ensure to exclude the 50cm Connecting Cable

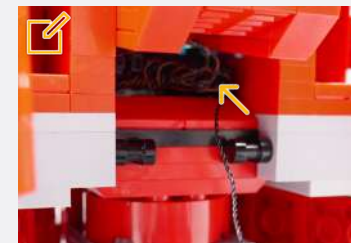

Legend

- DISCONNECT
- CONNECT / RECONNECT
- TURN / FLIP
- DIRECTIONAL
- TWIST / BRAID
- POWER ON TEST
- NOTE ICON

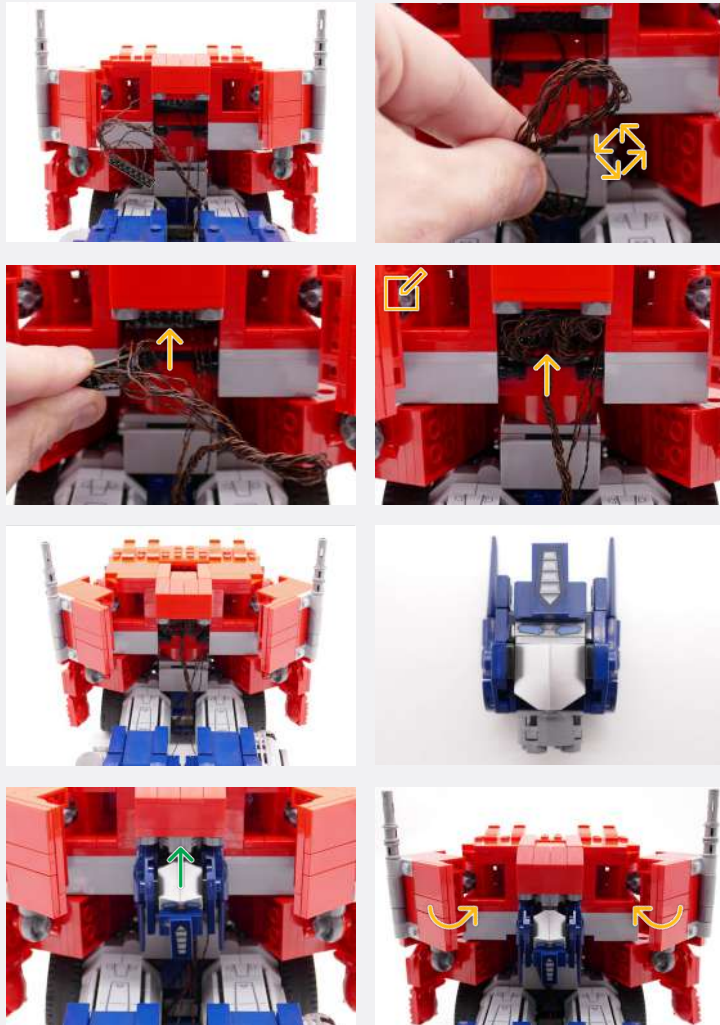

✍ Insert the final 8-Port Expansion Board into the same cavity, then the twisted wire

18

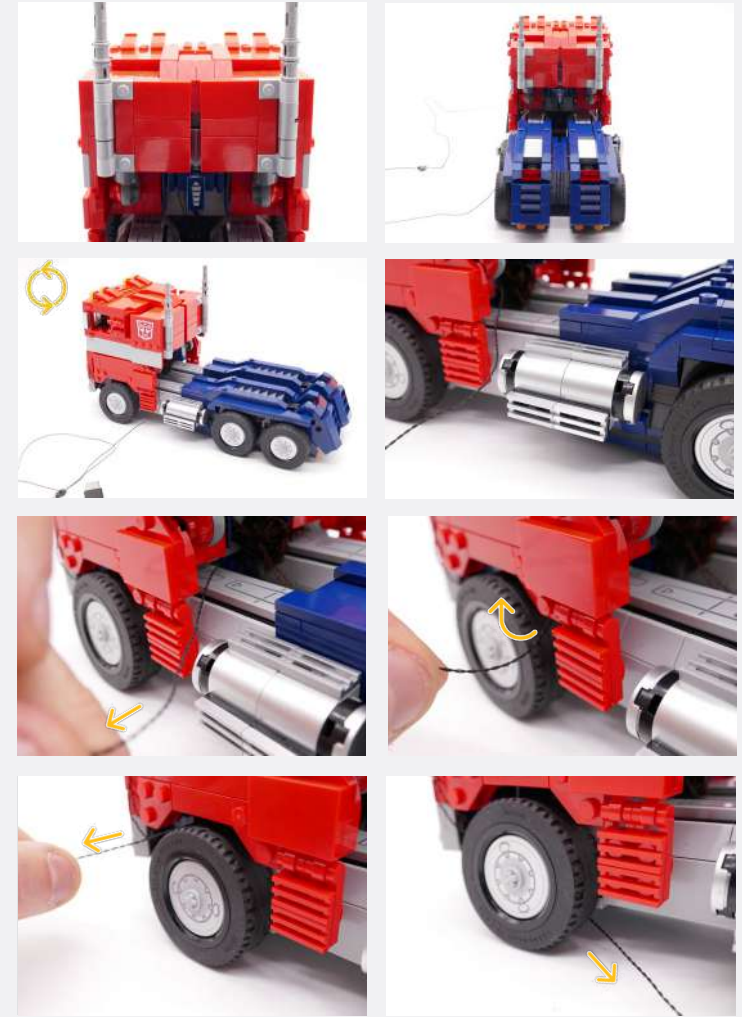

Legend → DISCONNECT → CONNECT / RECONNECT ↻ TURN / FLIP → DIRECTIONAL ↻ TWIST / BRAID ✨ POWER ON TEST ✍ NOTE ICON



 Connect to a power source - 5V USB Power Bank, 5V USB Wall Adaptor, or USB to AA Battery Pack (sold separately)



19

Legend  DISCONNECT  CONNECT / RECONNECT  TURN / FLIP  DIRECTIONAL  TWIST / BRAID  POWER ON TEST  NOTE ICON

FINAL PRODUCT

This finally completes installation of the Light My Bricks
LEGO Optimus Prime 10302 21332 Light Kit.





TROUBLESHOOTING

Light My Bricks lighting kits contain individual components that are very small and can be easily damaged if not handled correctly.

To prevent unnecessary damage to components, we highly recommend that the User Guide section, **“Important things to note”** is read carefully. Follow the handling procedures in the User Guide to help prevent faults and damages to your Light My Bricks components.

If you are experiencing issues with your Light My Bricks set, watch our troubleshooting video [here](#) or read on for a list of common causes to help you troubleshoot.

Troubleshooting

Firstly, ensure that the batteries have power using a battery charge gauge.

If the batteries have no power, replace the batteries.

If the batteries still have power, check to see if the batteries have been inserted correctly into the battery pack.

Check For CR2032 Batteries Using The Flat Battery Pack

Inside the battery pack is a symbol indicating which side the (round) CR2032 battery should be inserted. Check that the “+” side of the battery pack has the battery with the “+” symbol facing downwards.

On the opposite side, the “-” side of the battery pack should have the battery flipped upside down, that is the “+” symbol facing upwards.

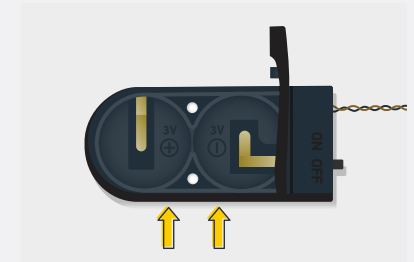

Troubleshooting

Check For Cr2032 Batteries Using The Round Battery Pack

Inside the battery pack is a symbol indicating which side the (round) CR2032 battery should be inserted. In this case, for the stacked battery pack, ensure that BOTH batteries have the “+” symbol facing upwards.

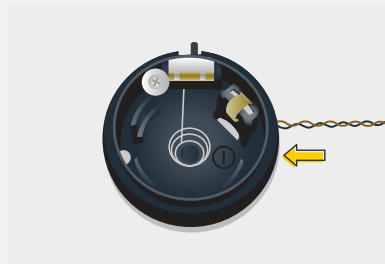

Check for AA batteries using the AA battery pack

Inside the battery pack are symbols indicating which direction the AA battery should be inserted. The flat side of the battery should be paired with the spring side of the battery pack.

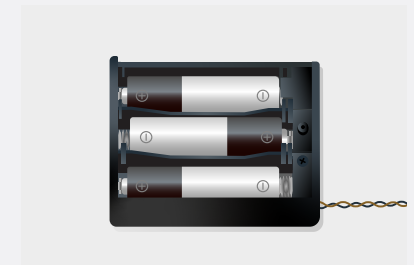
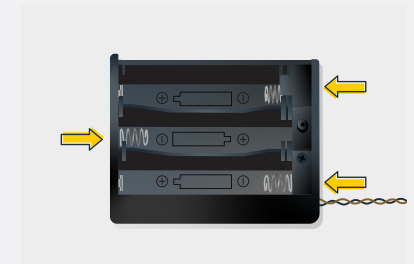

If the batteries have been installed correctly and your kit still isn't operating correctly, the next step is to check the wiring.

Troubleshooting

Check Your Wires

In order for Light My Bricks components to fit in between and underneath LEGO® bricks, the components need to be very small. Due to this nature, Light My Bricks components can be easily damaged when not handled correctly.

Be careful when removing unpacked components out of the packaging and ensure not to forcibly pull at the wires as this can damage the soldering that attach the wires to the LEDs.

If the wiring is detached from the LED itself, the light will not operate.

When connecting lights to your LEGO set, check that there are no pinched wires underneath or in between bricks and plates. When the wires are pinched and the exposed wires are touching each other, this can cause a crosswire and the lights to not function correctly.

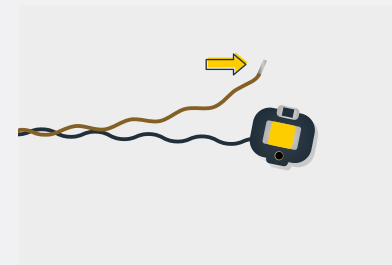
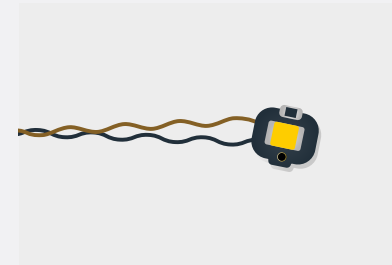

Troubleshooting

Check Your Expansion Board Ports/ Strip Light Ports / Effects Board Ports

It is important to note that connectors can only be inserted to the expansion board, strip light, or effects board ports in one direction.

Forcibly inserting connectors in the incorrect direction will result in damaging the pins inside each of the ports on your component board.

Not only will a light connected to the damaged port not work, but if the pins inside the port are bent to a point they are touching each other, this can result in all other lights in the system to stop working. This is a short circuit.

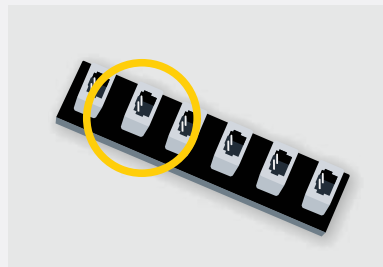

A short circuit can also result in overheating of the board, cable or batteries. If you suspect a short circuit, **DISCONNECT POWER IMMEDIATELY**. Batteries can fail, catch fire, or even explode if left connected to a short circuit for too long.

If you suspect you have a faulty component due to a bent pin, try the following steps:

If you look carefully inside each of the ports, each port contains 2 small pins that should be straight. You will be able to identify a faulty port if it has any bent pins.

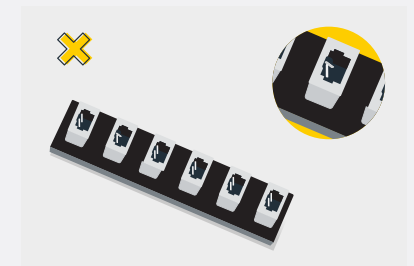
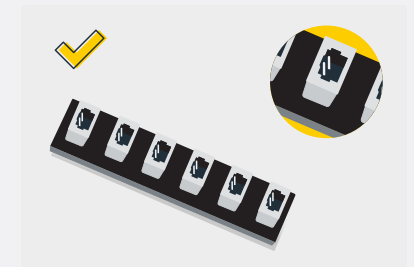
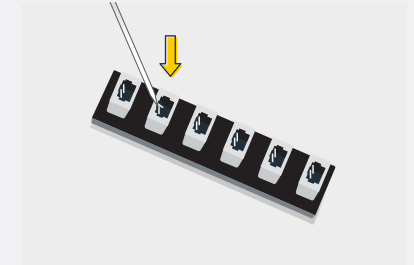



CONTACT US

If you have an enquiry regarding the online shop, our products or a general enquiry please refer to our Frequently Asked Questions webpage here.

Alternatively, you can contact our Customer Services team by visiting our online support portal here.

support.lightmybricks.com

We thank you for purchasing this product and hope you enjoy!



lightmybricks.com