



FS-GT3C

GT3C

INSTRUCTION MANUAL

用户手册



Digital propotional radio control system

[Http://www.flysky-cn.com](http://www.flysky-cn.com)
Copy right 2008@flysky co., ltd

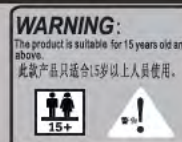



menu

1.INTRODUCTION	2
2.SERVICES.....	2
3.THE SPECIAL SYMBOLS.....	3
4.SAFTY GUIDES.....	3
5.2.4GHZ SYSTEM.....	4
6.BATTERY CHARGING NOTES.....	5
6.01 TRANSMITTER CHARGER.....	5
6.02 RECEIVER CHARGER.....	5
7.TANSMITTER PARAMETERS.....	6
8.RECEIVER PARAMETERS.....	6
9.RECEIVER CONNECTIVITY.....	7
9.01 INSTALLATION WHEN A MOTOR CONTROLLER IS USED.....	7
9.02 INSTALLATION FOR GAS POWERED MODELS.....	8
10.2.4G OPERATION NOTES.....	9
10.01 MATCHING (CODE)	9
10.02 POWER.ON.....	10
10.03 SHUT.DOWN.....	10
11.EACH PART OF THE TRANSMITTER.....	11
12. LCD FUNCTION EXPLANATION.....	13
12.01 LCD DISPLAY.....	13
12.02 OPENING SCREEN.....	13
12.03 MODEL.....	14
12.04 NAME.....	15
12.05 REV.....	16
12.06 E.POINT.....	17
12.07 TRIM.....	18
12.08 D/R.....	19
12.09 EXP.....	20
12.10 ABS.....	21
13.TRANSMITTER FUNCTION NOTES.....	22
13.01 STEERING CONTROL.....	22
13.02 THROTTLE CONTROL.....	23
14. FAIL SAFE FUNCTION.....	24
15.SIMULATE.....	25
16.PACKAGING WITH CONTENT LIST.....	26

1. INTRODUCTION

Thank you for choosing 2.4 G ratio remote control digital products, if you are the first time to use this type of products, please read this statement carefully and strictly in accordance with the requirements of operation. You could refer to the manual if you meet any problems during the operation. Please well keep the manual after use because you might have to use it again next time. Once again, thanks for buying our products.

FLYSKY

非常感谢您选择使用  2.4G数码比率遥控产品，如果你是第一次使用该类产品，请您在使用之前先仔细阅读此说明书，并严格按说明要求进行操作。在操作过程中您如果遇到问题同样可以查看说明书。说明书在使用完后请您妥善保管好，以备后用。再次感谢您使用  的产品，并希望它能给您带来快乐。

FLYSKY

2. SERVICES

If you find any problems during the operation process, please refer to the manual. If the problem still exist, you could contact our dealers to find out the way to solve. And you could also log on to our website service center:

[HTTP:WWW.FLYSKY-CN.COM](http://www.flysky-cn.com)

如果您在使用过程中发现有问題,请您第一时间先查看数控明书.如果问題还不能解决,您可以跟我们的经销商联系解决.您也可以登陆我们的服务中心网站:

[HTTP:WWW.FLYSKY-CN.COM](http://www.flysky-cn.com)

3. THE SPECIAL SYMBOLS

Please pay attention to the following symbols when it appears on the manual, and read carefully.

此说明书中有如下符号的地方请您特别注意，并仔细阅读。



Danger:

If the operator does not operate by following the instructions, the operator may lead to serious injuries, even mortal danger.

如果操作者不按正常操作方法操作，可能导致操作者严重受伤，甚至致命危险！



Warning:

If the operator does not operate by following the instructions, the operator may lead to serious injuries, even mortal danger.

如果操作者不按正常操作方法操作，可能导致操作者严重外伤，重伤或者致命情况！



Attention:

If the operator does not operate by following the instructions, the operator may lead to minor injuries, but generally it will not cause serious injuries to the operator.

如果操作者不按正常操作方法操作，可能会导致操作者轻伤，但一般不会对操作者造成重伤！



Prohibition

禁止



Mandatory

强制

4. SAFETY GUIDES



Don't fly at night, bad weather such as rainy or thundering days. It will interfere the transmitter signal. Thereby it will create out of control and unexpected accident.

请您不要在夜晚，刮风或下雨时使用，因为这样的天气环境会对遥控设备产生干扰，从而导致失控而产生意外！



Before you fly, please make sure the movement of server correspond with the direction of joysticks. If inconsistent, please adjust before fly.

在飞行前，请您务必先检查伺服器的各项动作是否与对应操纵杆的方向一致，如果不一致，请调整后再使用。



You need to turn the throttle channel(ch2) and inching switch to the lowest before You use. Then switch on the transmitter power, finally connect the receiver.

开机使用时请您勿必先将油门通道（CH2）及微调置最低端。然后打开发射机电源并检查电源电量，再接通接收机电源。

The sequence to shutdown is that turn off the receiver power first, and then the transmitter power.



If the above operations are reverse, it might lead to uncontrolled and cause Accident.

停止使用前请您先关闭接收机电源然后关闭发射机电源。

以上操作如果反向，可能导致失控，从而产生意外！



AFHDS

AUTOMATIC FREQUENCY HOPPING DIGITAL SYSTEM

AFHDS(自动跳频数字系统), 这个系统是富斯公司专为模型爱好者自主研发, 并具有自主知识产权的一套数字无线系统。它是专门针对模型产品而研发的, 它具有超强的主动和被动抗干扰能力及极低的使用功耗和极高的接收灵敏度, 是目前市面上最好的系统之一。此系统经过研发人员极端严格的测试及多年市场验证, 模型爱好者完全可放心使用!

AFHDS (automatic frequency hopping digital system), is developed by FLYSKY for all the Radio Control model lovers and is patented by FLYSKY at home. The system is specially developed for all the Radio control models, that offers super active and passive anti-jamming capabilities, very low power consumption and high receiver sensitivity. With extreme rigorous testing by engineers and studying the markets for years, FLYSKY AFHDS is now considered to be the one of the best systems available in the market.

参数说明:

频率范围: 2.40-2.4835GHz;
波段宽度: 500Hz;
波段个数: 160个;
发射功率: 不高于20dBm (100mW);
2.4G模式: 自动跳频数字系统;
编码方式: GFSK;
天线长度: 26毫米;
接收灵敏度: -105dBm.

Specifications:

RF range: 2.40-2.4835GHz;
Bandwidth: 500Hz;
Band sum: 160;
RF power: less than 20 dBm;
2.4G system: AFHDS;
Code type: GFSK;
ANT length: 26mm;
RX Sensitivity: -105dBm;

系统特征:



多频点跳频工作:

此系统工作波段为2.40GHz到2.4835GHz, 分160个频点, 每个系统使用其中不同的160个频点工作及160种跳频频率, 从而通过开机时间不同及跳频频率不同和使用频点不同, 尽最大可能使使用者的之间不会同频, 从而主动避开同频的干扰。

The system works in between 2.400GHz to 2.4835GHz frequencies that have been divided into 160 frequency points. Each system uses 160 frequencies points and 160 hopping frequency. By using various switching-on time, frequency hopping and different frequency points, the system can passively avoid frequency jamming.



全角度增益天线:

此系统采用的是线性优良的全波段的增益天线, 天线带宽覆盖整个波段宽度, 可大大提升系统发射效率及接收的灵敏度。从而提升系统的稳定性, 并加强了自身被动抗干扰能力。

The system uses a linear spread of fine paragraph by excess antenna, which covers the entire band width of the antenna bandwidth range, greatly enhances the efficiency of the system launch and receiving sensitivity. It greatly improves system stability, and strengthen the passive anti-jamming capability of the system.



独立身份识别系统:

此系统每个发射机都具有唯一的身份识别ID码, 当与接收机进行对码后此ID码被存放在接收机内, 当接收机工作时首先会验证此ID码是否正确, 然后才工作, 否则不会工作。此项可加大系统的主动抗干扰能力, 从而提升系统的稳定性。

Each transmitter has its own unique ID. When the transmitter communicates with the receiver, the ID will be transmitter and saved in the receiver. The System works only when the ID is matched when the receiver powers on. This dramatically increases the ability of passive anti-jamming and enhances the total stability of the system.



低功耗工作:

此系统完全采用超低功耗器件, 且接收采用高灵敏度的接收芯片, 工作时采用间隔发送方式。从而降低了发射功率, 并提升了使用工作时间。此系统使用功耗相当于以前FM版本的十分之一。

The system uses low power consumption components, and the receiver chip is extremely sensitive; the system uses interval signal transmission, thereby reducing the transmission power, and increasing the operating. Comparatively this system consumes only one tenth of the normal FM system.

6. BATTERY CHARGING NOTES



If your transmitter, receiver using a nickel-cadmium, nickel-metal hydride rechargeable battery, you have to well-check before you use. If lack of electricity, it could happen those phenomenon like inadequate control or out of control, resulting accident. So please charge immediately when the battery lacks of electricity.

如果您的发射机、接收机使用的是镍镉、镍氢等可充电电池,在使用前请您务必检查电池电量。如果电量不足,可能导致控制距离不够或者失控的现象,从而产生意外。所以电池电量不足时请及时充电。



If you are using a nickel-cadmium, nickel-metal hydride batteries for recharging, please use our company dedicated charger. If the electrical current is too large and it may lead to temperature over-heated and cause fire burning accident. Please cut off the power supply immediately after recharging. Please take out the battery from the transmitter when you are not using it within a period, it is because the battery may damage the aircraft batteries, thus being exposed.

如果您使用的是镍镉、镍氢电池进行充电,请您使用我们公司的专用充电器。因为如果充电电流太大可能导致电池温度太高,从而燃烧起火带来意外。充电完成请您即时切断电源。当您长时间不使用时请您从发射机中取出,因为电池可能导致发射机电池片损坏,从而接触不良。

6.01 DC(Direct Current) charging:

1. Install one side of the charger to the power connector, while the other side to the port of the USB (as picture 1), charge indicator turns red at this time.
2. Cut off the power supply after the process of charging completed. (The indicator light on the transmitter turns into green).



①

直流充电

将充电器插入电源接口,另一端插入发射机的USB充电接口(如图1),此时充电指示灯变成红色;
充电完成后,发射机上的充电指示灯为绿色,即可切断充电电源。

6.01.1 Charging by computer:

1. Install the rechargeable battery to the transmitter.
2. Install one side of the software to the port of USB on the computer, while the port of the USB on the transmitter. (as picture 2), charge indicator turns red at this time;
3. Take out the software after the process of charging completed. (the indicator light on the transmitter turns into green.)

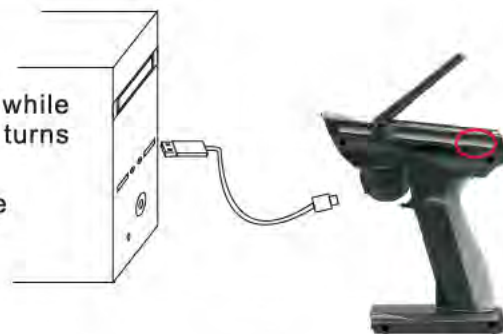

②

电脑充电

将可充电电池按方向装入发射机;
将数据线一段插入电脑USB插孔,另一端插入发射机USB插孔(如图2),此时充电指示灯变成红色;
充电饱和后,发射机上充电指示灯为绿色时,将其数据线拔出。

6. BATTERY CHARGING NOTES

6.01.2 Charging by charger:

1. Install the rechargeable battery to FS-BC101.
2. Install one side of the charger to the power connector, while the other side to FS-BC101, or connect with the USB port of the computer directly, then the director of charger will turn to red;
3. When the indicator light on the charger turns into green, it means that the charge completed.
4. Cut off the power supply.

充电器充电

将电池按方向装入(FS-BC101;)

将充电器插入电源接口，另一端插入(FS-BC101)充电器，或者直接连接电脑USB，此时充电指示灯变成红色；

充电器上的充电指示灯显示绿灯时，充电已完成；

充电完成后，即可切断电源。

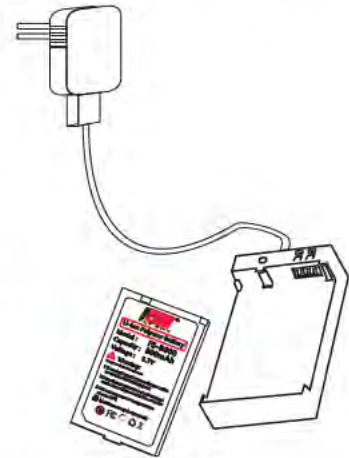

6.02 Receiver charger:

- A. Connect the charger to the commercial power connector.
- B. Connect the Rechargeable receiver with battery charger
- C. Recharge completed, cut off the power supply immediately.

1. 将充电器插入市电接口；
2. 将可充电接收机用电池接口与充电器充电接口连接；
3. 充电完成后，即时将电源切断。

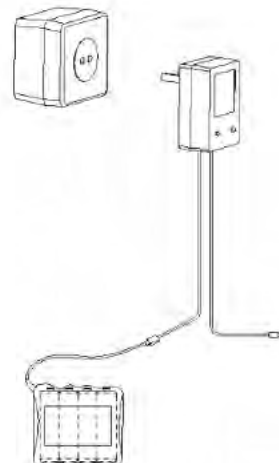

7. TRANSMITTER PARAMETERS

Specifications:

1. 通道个数: 3个通道;
2. 适合机种: 车、船;
3. 发射功率: 小于等于20dBm (100mW);
4. 调制方式: GFSK;
5. 系统模式: AFHDS;
6. 数据分辨率: 1024级;
7. 低电压报警功能: 有 (低于3.7伏后);
8. 数据输出接口: 有 (3.5英寸);
9. 充电接口: 有 (USB);
10. 电源标准: 3.7V (800毫安锂电);
11. 整机重量: 328克;
12. 天线长度: 26毫米;
13. 外形尺寸: 151*138*116毫米;
14. 外观颜色: 黑色;
15. 安规认证: CE, FCC;

SPECIFICATIONS:

- A. Channels: 3channels;
- B. Model type: car/boat;
- C. RF power: no more than 20dBm(100mW);
- D. Modulation: GFSK;
- E. System type: AFHDS;
- F. Sensitivity: 1024;
- G. Low voltage warning: yes (less than 3.7V);
- H. DSC port: yes (3.5mm);
- I. Charger port: yes USB;
- J. Power: 3.7V (800mAh);
- K. Weight: 328g;
- L. ANT length: 26mm;
- M. Size: 151*138*116mm;
- N. Color: black;
- O. Certificate: CE FCC.



MODELS: FS-GT3C



8. RECEIVER PARAMETERS



MODEL: FS-GR3C

机种参数:

1. 通道个数: 3个通道;
2. 适合机种: 车/船;
3. 接收灵敏度: -105dBm;
4. 调制方式: GFSK;
5. 系统模式: AFHDS;
6. 数据分辨率: 1024级;
7. 失控保护功能: 有 (第2通道);
8. 对码接口: 有 (第3通道);
9. 电源接口: 有 (VCC);
10. 电源标准: 4.5-6.5VDC (1.5伏*4);
11. 整机重量: 5克;
12. 天线长度: 26毫米;
13. 外型尺寸: 37.6*22.3*13毫米;
14. 外观颜色: 黑色;
15. 安规认证: CE FCC

SPECIFICATIONS:

- A. Channels: 3channels;
- B. Model type: car/boat;
- C. RF receiver sensitivity: -105dBm;
- D. Modulation: GFSK;
- E. System type: AFHDS;
- F. Sensitivity: 1024;
- G. Faisafe: yes (channel 2);
- H. Bind port: yes (channel 3);
- I. Power port: yes (VCC);
- J. Power: 4.5-6.5VDC (1.5V*4);
- K. Weight: 5g;
- L. ANT length: 26mm;
- M. Size: 37.6*22.3*13mm;
- N. Color: black;
- O. Certificate: CE FCC.



9. RECEIVER CONNECTIVITY

9. 01 INSTALLATION WHEN A MOTOR CONTROLLER IS USED:

带马达模型的安装连接

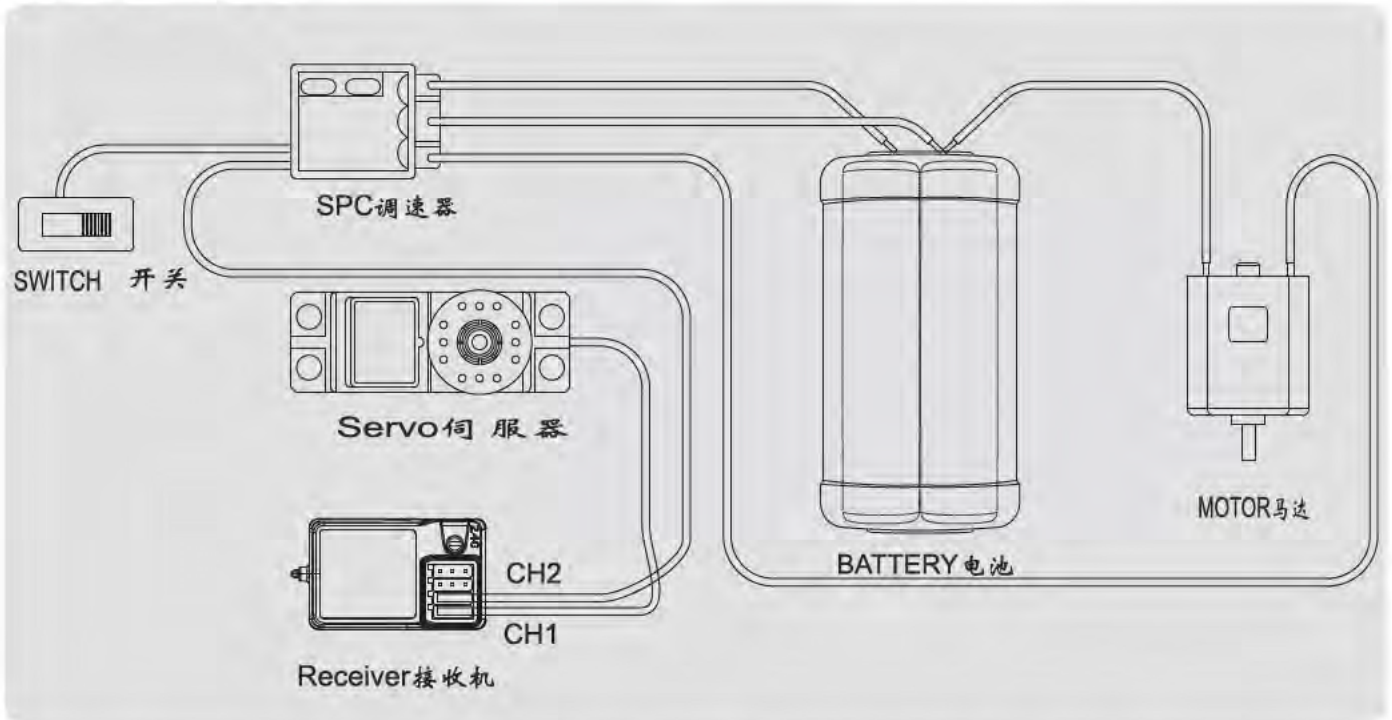

Remark: Place the antenna of the receiver vertically with the plane!
 And don't let it close to the metal thing for assuring its sensitivity. (See pic1)
 注: 在安装接收机时请将接收机天线与水平面垂直放置! 且天线尽可能不要靠近金属物! 因为这样接收灵敏度最高。(如图1)

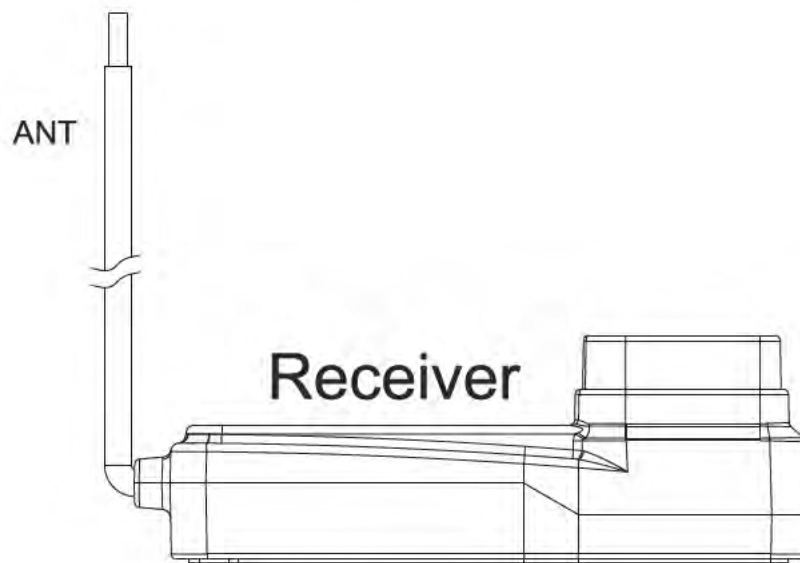
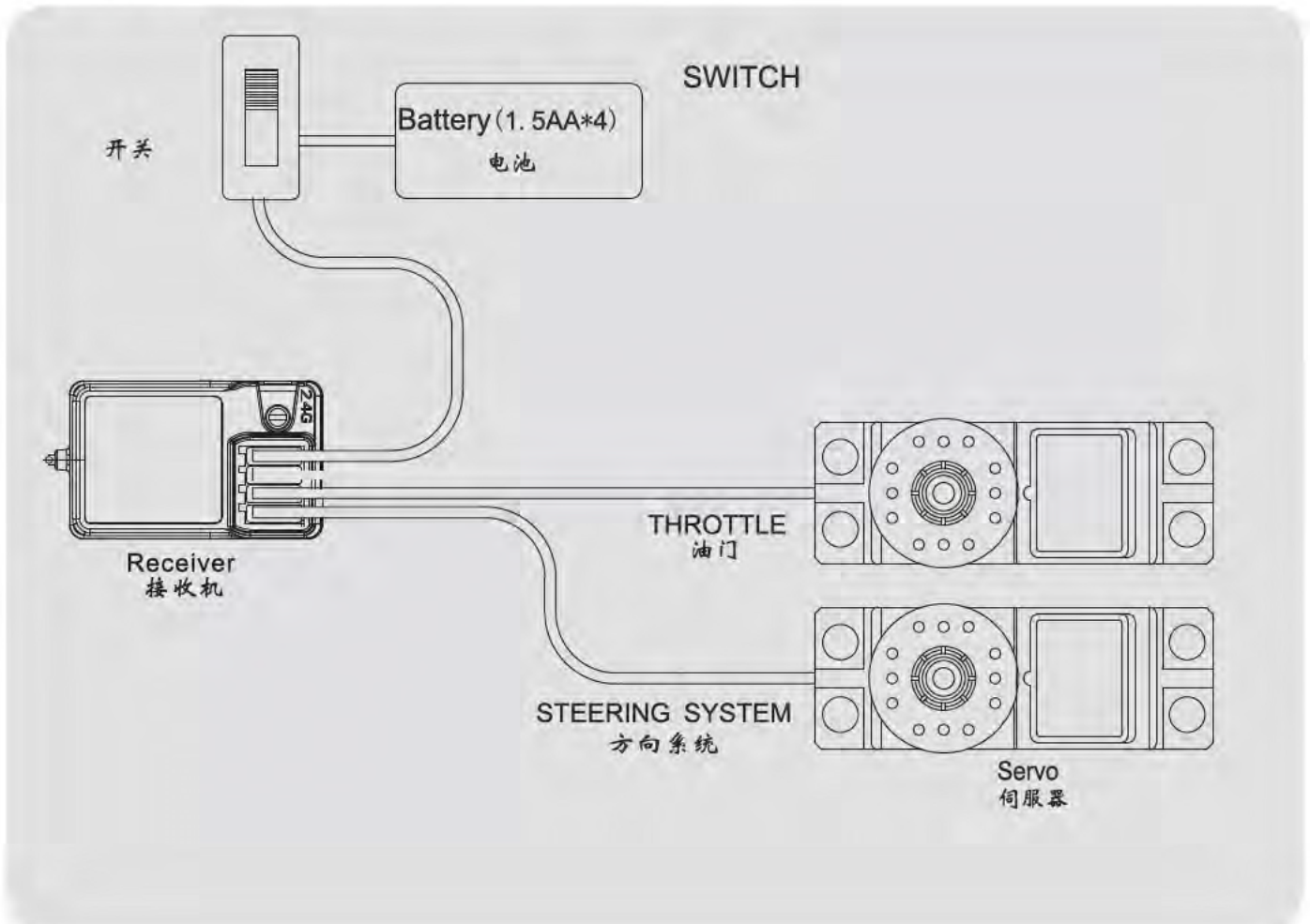

Figure 1 (图1)

9. 02INSTALLATION FOR GAS POWERED MODELS:

发动机模型的安装



10.2.4G OPERATION NOTES

10.01 MATCHING (CODE)

Our products are well matched in the factory, you do not need to match by yourself. But if you are going to match the receiver with other transmitter, or you need to change a new receiver or transmitter, please follow the following steps:

- A. Install the battery to 2.4G transmitter and shut it down.
- B. Insert the matching lines to the channel BIND /CH3 port of the receiver. (Figure.1)。
- C. Connect the receiver battery to VCC port of the receiver, on the same time the two LED are flashing and this means the receiver are going to the matching status.
- D. Press and hold the button on the transmitter, and then switch on the power supply.
- E. Observe the LED on the receiver, if find that the LED is not flash anymore and that means successful Matched. (This process about 5s)
- F. Release the match button on the transmitter, take out the match line.
- G. Install the server and then test.
- H. If the tests fail, please repeat the action above.
- I. If the tests success, then insert the power supply port into VCC, match complete.
(The above ways of match is only suitable for FLYSKY 2.4G products)

我们的产品出厂前已经过配对，您无需做配对动作便可使用。但如果您要将接收机跟另外的发射机进行配对使用，或者您要更换新的接收机或者发射机，请您按如下的步骤进行：

注：我们的接收发射系统，不跟其它品牌兼容！

- 1.将2.4G发射机装好电池，并关闭发射机。
 - 2.将配对线插入接收机的BIND/CH3通道接口（如图1）。
 - 3.将接收机电池插入接收机的VCC通道接口，此时可看到接收机的LED在闪烁，此表示接收机进入配对状态。
 - 4.将发射机上的配对键(BIND)按住，然后打开发射机电源开关。（注：不要松开按键）。
 - 5.观察接收机上的LED，如果发现LED不再闪烁表示配对成功。（注：此过程大约时间为5S左右）。
 - 6.松开发射机上的配对按键，拔掉接收机上的配对线。
 - 7.将伺服器装上并通电测试。
 - 8.如果测试NG，则重复以上动作。
 - 9.如果测试OK，则将电源接头插入VCC，配对完成。
- 注：以上配对方法，仅适合于FLYSKY的2.4G产品。

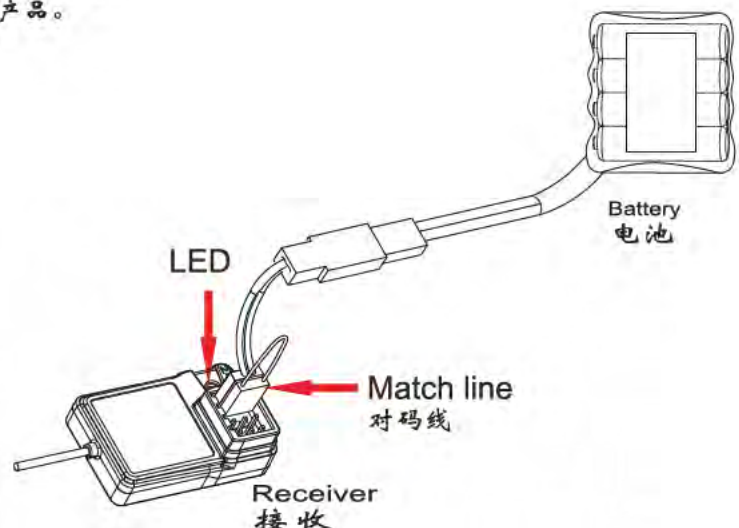

Figure 1 (图1)

10. 02 POWER ON:

- A. Connect every part.
- B. Switch on the power supply of the transmitter.
- C. Connect the power supply of the receiver.
- D. Receive LED light solid.
- E. Finish and use.

1. 将各部件连接好;
2. 打开发射机电源开关;
3. 连通接收机电源;
4. 接收机LED恒亮;
5. 使用.



Tx power ON



Power on

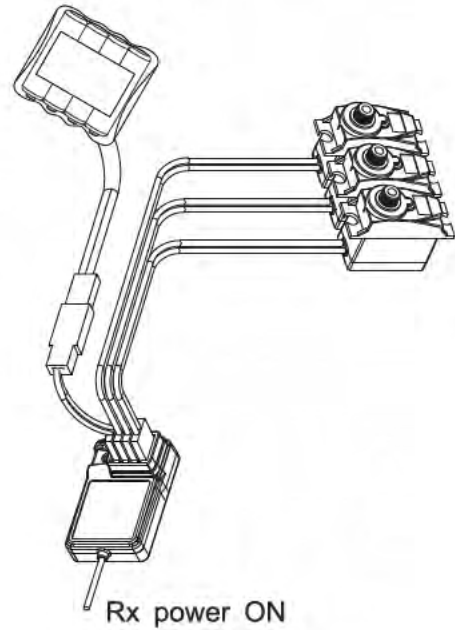

Rx power ON

10. 03 SHUT DOWN:

- A. Cut off the receiver power supply.
- B. Cut off the transmitter power supply.

1. 关闭接收机的电源;
2. 关闭发射机的电源.

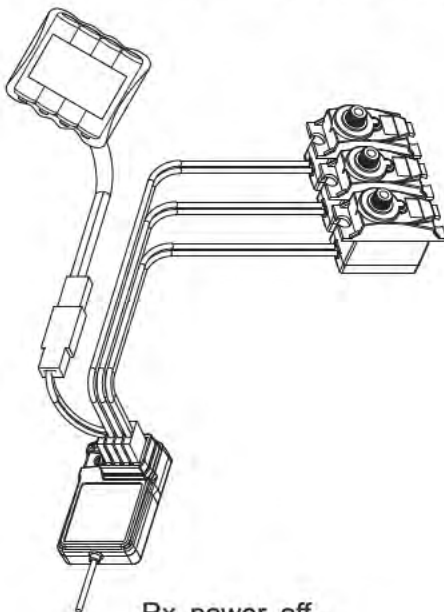

Rx power off



Shut down



Tx power off

II. EACH PART OF THE TRANSMITTER



- ① 2.4G ANT ② STEERING WHEEL ③ CH3 ④ BAT BOX
- ⑤ D/R ⑥ Ch3 TRIM ⑦ POWER



- ⑧ USB PORT
- Ⓐ THROTTLE TRIGGER



- Ⓐ CHG LED Ⓑ LCD Ⓒ BACK Ⓓ BIND Ⓔ END Ⓕ ENTER (RIGHT/LEFT)
- Ⓖ TH TRIM (DOWN) Ⓗ TH TRIM (UP) Ⓘ ST TRIM (LEFT) ⓵ ST TRIM (RIGHT)

12. LCD FUNCTION EXPLANATION

12. 01 LCD DISPLAY



BUTTON FUNCTION:

Turn the ENTER button counterclockwise: increase the rate
 Turn the ENTER button: decrease the rate
 Press ENTER button: select the menu
 Press BACK button: return to the menu
 Press END button: end the programming

按键定义:

左旋:逆时针旋转(做菜单选择及数据加);
 右旋:顺时针旋转(做菜单选择及数据减);
 确认:确认按键(做菜单选择确定);
 返回:返回按键(菜单返回);
 END:(结束某一项功能篇辑的操作键);

12. 02 OPENING SCREEN:



Show current model number and user name

Press ENTER button, the screen will be showing as following (voltage and model number):

显示当前机种编号及机种名

在此画面下按左右旋转键可显示如下画面(显示当前电池电压及MODEL编号):



在此画面下如果电压低于3.7V侧会出现如下画面:

此时LOW POWER!会闪烁,同时发出报警声。

s lower than 3.7V .



Following screen will be showed when the voltage i

“LOW POWER ” will be blinking, simultaneously buzzer will be warning.

12. 03MODEL:

Function explanation:

The radio (FS-GT3C) can be stored with ten memories (FS0-FS9), and each memory in the radio can be setup separately to match up with different models.

Parameter specification:

The initial model No. is Model "NO. 0".

ACB is for the name of model, the initial data is "FS0".

Operation:

Switch on the transmitter and press the "ENTER" button to be ready for choice, then turn to left or right to choose the model you want from the menu, then to press "ENTER" button and enter the next menu, meanwhile "8" will flash, at last turn left or right and confirm the model. (totally 10sets of memories. 0 to 9)

Press the "ENTER" button to finish the operation after edition. Then return to menu option

Press BACK button and return to the initial menu at any condition.

功能说明:

此发射机(FS-GT3C)可存放10组模式(FS0-FS9), 每组都可单独设定, 以适应不同的机型

参数说明:

MODEL No.: 机种编号(工厂预设值为MODEL NO. 0);

ACB: 机种名称(工厂预设值为FS0)。

操作方法:

在开机菜单下通过"确认"键进入菜单选择, 通过"左右旋转"键进行model菜单选择, 再按"确认"键进入此菜单的操作(此时"8"会闪烁), 然后按"左右旋转"键进行MODEL选择(共10组0-9)。

编辑完成后按"确认"键, 结束此菜单的编辑, 返回并进入菜单选择状态。

在任何状态下按"返回"键进入开机画面。

12. 04 NAME:

Function explanation:

This function allows you to assign a number to each model memory and a user name (three characters).

Parameter specification:

MODEL No: Model number

ACB: User name

Operation:

Press the “ENTER” button and turn to select the NAME option. The selected function will be blinking. Select the channel by turning the “ENTER” button, and then press the “END” button. Turn the “ENTER” button to select letter. After this, press the “END” button to finish the setting. The rest can be done in the same way. After finishing the setting of three channels, press the “ENTER” button to return to menu screen.

Press “BACK” to return to the opening screen.

功能说明:

此功能是对发射机存放的机种进行名字的编写(使用三个字符),以方便记忆及调用. 可使用的字符为:0123456789ABCDEFGHIJKLMNOPQRSTUVWXYZ.

参数说明:

MODEL No.: 机种编号;

ACB: 机种名称。

操作方法:

在开机菜单下通过按“确认”键进入菜单,通过“左右旋转”键进行NAME菜单选择,再按确认键进入此菜单的操作(此时第一字符“B”会闪烁),然后通过“左右旋转”键进行此字符的编写,此时如需对第二个字符进行编写,先按“END”键此时第二个字符会闪烁,并进入可编辑状态。依类推对三个字符进行编辑.连续按“END”则在三个字符中来回切换。编辑完成后按“确认”键返回并进入菜单选择状态。在任何状态下按“返回”键进入开机画面。

12. 05 REV:

Function explanation:

This function reverses the direction of the operations of servos: steering, throttle, and channel 3.

Parameter specification:

CHANNEL: channel number, from 1 to 3

REV: reverse

NOR: normal

Operation:

Press the “ENTER” button and turn to select the TRIM option. The selected function will be blinking. Select the channel by turning the “ENTER” button, and then press the “END” button (now the “REV” or “NOR” will be blinking). Turn the “ENTER” button to select “REV” or “NOR”. After this, press the “END” button to finish the setting. The rest can be done in the same way. After finishing the setting of three channels, press the “ENTER” button to return to menu screen.

Press “BACK” to return to the opening screen.

功能说明:

此功能是对三个输出通道做正反向输出的设定，以适应不同机种及不同伺服器规格的要求。

参数说明:

CHANNEL: 通道编号，从1到3。

REV: 反向输出。

NOR: 正向输出(工厂预设值为NOR)。

操作方法:

在开机菜单下通过“确认”键进入菜单，通过左右旋转键进行REV菜单选择，再按确认键进入此菜单的操作(此时1”字符会闪烁)，然后通过左右旋转键进行通道1到通道3的选择，选好后要变更的通道后按“END”键，此时三个字符(REV或NOR)会闪烁，在此状态下按左右旋转键进行REV与NOR的设定。完成后按END”键可进入第二个通道的设定。依类推对三个通道都可进行设定。

编辑完成后按“确认”键返回并进入菜单选择状态。

在任何状态下按“返回”键进入开机画面。

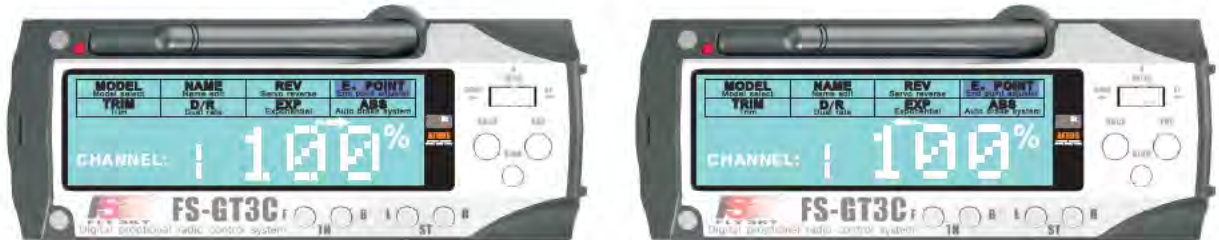
12. 06 E. POINT:

Function explanation:

Use this function when performing left and right steering angle adjustments, throttle high Side/brake side amount adjustment, and channel 3 servos up side/down side operation amount adjustment during linkage setup. Used to correct steering angle of adjusting left and right steering angles when there is a difference in the Left and Right turning radii.

Parameter specification:

CHANNEL: channel number, from 1 to 3

100%: output value. Adjustment range: 0~120% (initial value is 100%)

←: LEFT, FORWARD or RIGHT, BACK (select by steering wheel or throttle trigger)

Operation:

Press the "ENTER" button and turn to select the TRIM option. The selected function will be blinking. Select the channel by turning the "ENTER" button, and then press the "END" button (now the icon will be blinking). Turn the "ENTER" button to adjust the rate. After this, press the "END" button to finish the setting. The rest can be done in the same way. After finishing the setting of three channels, press the "ENTER" button to return to menu screen. Press "BACK" to return to the opening screen.

功能说明:

此功能是对三个输出通道做输出变化量的调整设定, 此项设定分为两部份(正半部负半部份)来分别单独进行设定, 应适应不同机种及不同伺服器输出量的要求, 另外对伺服器的两边输出行程不对称做修正。

参数说明:

CHANNEL: 通道编号, 从1到3。

100%: 输出量百分比率, 值越小输出越小, 反之越大(此调整量为0%到120%, 工厂预设值为100%)。

←/→: 此图标表示当前你所设定调整的是那一部份(分正负两部份, 由方向盘及油门扣机来选定)。

操作方法:

在开机菜单下通过“确认”键进入菜单, 通过“左右旋转”键进行E. POINT菜单选择, 再按“确认”键进入此菜单的操作(此时1字符闪烁), 然后通过“左右旋转”键进行通道1到3通道的选择, 选好要变更的通道后按“END”键, 此时三个字符会闪烁, 在此状态下通过方向盘及油门扣机进行单边选择(被选中的那边所对应的图标 ←/→ 会闪烁), 然后按“左右旋转”键进行0-120%的设定。完成后按“END”键可进入另一个通道的设定, 依类推对三个通道进行设定。编辑完成后按“确认”键返回并进入菜单选择状态。在任何状态下按“返回”键进入开机画面。

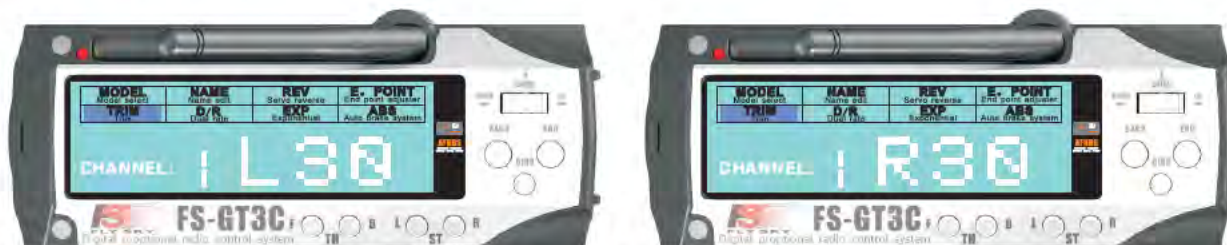
12. 07 TRIM:

Function explanation:

Use this function to adjust the neutral position of the steering, throttle and channel 3 servos.

Parameter specification:

CHANNEL: channel number, from 1 to 3;

R30: steering or 3rd channel right side, adjustment range: 0~30 (initial value is N00);

L30: steering or 3rd channel left side, adjustment range: 0~30 (initial value is N00);

F30: throttle forward side, adjustment range: 0~30 (initial value is N00);

B30: throttle backward side, adjustment range: 0~30 (initial value is N00)

Operation:

Press the "ENTER" button and turn to select the TRIM option. The selected function will be blinking. Select the the channel by turning the "ENTER" button, and then press the "END" button (now the percentage will be blinking). Turn the "ENTER" button to adjust the rate. After this, press the "END" button to finish the setting. The rest can be done in the same way. After finishing the setting of three channels.

Press the "ENTER" button to return to menu screen.

Press :BACK" to return to the opening screen.

功能说明:

此功能是对三个输出通道中立点微调的设定，调整修正机种在装配及伺服系统中心点不对产生的偏差。以使车或船等模型在操控时更加直线。

参数说明:

CHANNEL: 通道编号，从1到3。

R30: 通道右边微调，调整量为0-30，工厂预设值为N00。

L30: 通道左边微调，调整量为0-30，工厂预设值为N00。

F30: 通道前进微调，调整量为0-30，工厂预设值为N00。

B30: 通道后退微调，调整量为0-30，工厂预设值为N00。

操作方法:

在开机菜单下通过“确认”键进入菜单，通过“左右旋转”键进行TRIM菜单选择，再按“确认”键进入此菜单的操作(此时1字符会闪烁)，然后通过“左右旋转”键进行通道1到通道3的选择，选好要变更的通道后按“END”键，此时三个字符会闪烁，在此状态下通过按“左右旋转”键进行L30-N00-R30(油门通到是F30-N00-B30)

设定调整。完成后按“END”键通道的设定。依类推对三个通道进行设定。

编辑完成后按“确认”键返回并进入菜单选择状态。

在任何状态下按:返回”键进入开机画面。

12. 08 D/R:

Function explanation:

By setting the dual rates function, you can limit the total travel of each individual Channel.

Parameter specification:

CHANNEL: channel number, from 1 to 3;

100%: Dual Rate, when you want to increase the servo travel, turn the button to increase the rate. When you want to decrease the servo travel, turn the button to decrease the rate. 0% is no signal output, 100% is maximum signal output. Adjustment range: 0~100% (initial value is 100%)

Operation:

Press the "ENTER" button and turn to select the D/R option. The selected function will be blinking. Select the channel by turning the "ENTER" button, and then press the "END". After this, press the "END" button to finish the setting. The rest can be done in the same way. After finishing the setting of three channels; press the "ENTER" button to return to menu screen.

Press "BACK" to return to the opening screen.

功能说明:

此功能是对三个输出通道做输出变化量调整设定, 此项设定同时对两部份 (正半部负半部份) 按同一比率进行设定, 适应不通机种及不同伺服器输出的要求, 以达到最佳的操控效果。

参数说明:

CHANNEL: 通道编号, 通道1到通道3;

100%: 输出量百分比率, 值越小输出越小, 反之越大 (此调整量为0%到100%, 工厂预设值: 为100%), 0%表示此通道没有输出, 100%表示全部输出, 也就是最大输出。

操作方法:

在开机菜单下通过“确认”键进入菜单, 通过“左右旋转”键进行D/R菜单选择, 再按“确认”键要变更的通道后按“END”键, 此时三个字符会闪烁, 在此状态下按“左右旋转”键进行0-100%进入此菜单的操作 (此时1字符会闪烁), 然后通过“左右旋转”键进行通道1到通道3的选择, 选好的设定。完成后按“END”键可进入另一个通道的设定。依类推对三个通道进行设定。

编辑完成后按“确认”键返回并进入菜单选择状态。

在任何状态下按“返回”键进入开机画面。

12. 09 EXP:

Function explanation:

This function is used to change the sensitivity of steering servo's 3 channels around the neutral position. In order to "soften" the response according to user's demand.

Parameter specification:

CHANNEL: channel number, from 1 to 3;

100%: steering EXP rate, when you want aggressive steering operation, turn the button to increase the rate. When you want to make steering operation less aggressive, turn the button to decrease the rate.

Adjustment range: -100%~0~+100% (initial value is 0)

Operation:

Press the "ENTER" button and turn select the EXP option. The selected function will be blinking.

Select the channel by turning the "ENTER" button. and then press the "END" button (now the percentage will be blinking). Turn the "ENTER" button to adjust the rate. After this, press the "END" button to finish the setting. The rest can be done in the same way. After finishing the setting of three channels.

Press the "ENTER" button to return to menu screen.

Press "BACK" to return to the opening screen.

功能说明:

此功能是对三个输出通道作指数变化量调整设定, 适应不通机种对不同赛道以及不同人的操作习惯, 以达到最佳的操控效果。

参数说明:

CHANNEL: 通道编号, 通道1到通道3. 100%: 指数输出百分比率, -100%表示中心点位置反应会越小, 也就是反应越迟钝; 100%表示中心点位置反应会越大, 也就是反应越灵敏, EXP调整量为: -100%到100% (工厂预设为0%)。

操作方法:

在开机菜单下通过“确认”键进入菜单, 通过“左右旋转”键进行EXP菜单选择, 再按“确认”键在进入此菜单的操作 (此时1字符会闪烁) 然后通过“左右旋转”键进行通道1到通道3的选择, 选好要变更的通道后按“END”键, 此时三个字符会闪烁, 在此时状态下按“左右旋转”键进行-100%到100%的设定. 完成后按“END”键可进入另一个通道的设定. 依类推对三个通道进行设定.

编辑完成后按“确认”键返回并进入菜单选择状态.

在任何状态下按“返回”键进入开机画面.

12. 10 ABS:

Function explanation:

While applying the brakes, locking them up can be easily done, which can cause your vehicle to spin out of control, this can be eliminated by pulsing the brakes, so that full control of your vehicle can be achieved at all times. The effect is like that of a A.B.S in a real passenger car.

Parameter specification:

CHANNEL: channel number, it's only available in channel 2;

OFF: A. B. S. function is OFF;

SLW: slow pulse;

NOR: normal pulse;

FST: fast pulse;

Handy Tips: this data car vary from servo to servo, the best choice is the type that is suitable for your car.

Operation:

Press the "ENTER" button and turn to select the ABS option. A selected function will be blinking. Turn the "ENTER" button to change the setting of ABS function, there are 4 settings: OFF, SLW, NOR, FST, press the "ENTER" button to return to menu screen.

Press "BACK" to return to the opening screen.

功能说明:

此功能是对油门输出通道作自动刹车(点刹)设定,适应不同机种赛道以及不同人的操作习惯,以达到最佳刹车效果及弯道的操控效果,而不至于有甩尾及转弯不足现象出现。

参数说明:

CHANNEL:通道编号,只有第二通道(油门通道)有此功能;

OFF:表示ABS功能关闭(工厂预设值为OFF);

SLW:表示ABS输出频率是最慢的;

NOR:表示ABS输出频率一般;

FST:表示ABS输出频率最快;

注:这几个参数需依据不同机型及不同种类的伺服器决定.不一定输出频率最快就最好,最慢就最差。

操作方法:

在开机菜单下通过"确认"键进入菜单,通过"左右旋转"键进行ABS菜单选择,再按确认键进入此菜单的操作(此时三个字符会闪烁),然后通过"左右旋转"键进行OFF-SLW-NOR-FST的设定。

编辑完成后按确认键"返回"并进入菜单选择状态。

在任何状态下按"返回"键进入开机画面。

13. TRANSMITTER FUNCTION NOTES

13. 01 STEERING CONTROL:



功能说明:

此功能是用来进行方向控制,当方向舵往右旋转时车子前轮会跟着往右(如图),当方向舵往左旋转时车子前轮会跟着往左(如图)。

操作方法:

开机后,通过方向舵进行方向控制,方向舵动作大小依据实际情况进行比率调整.方向舵大小动作量可通过D/R进行大小舵量的调整。

Function explanation:

This function is to control the direction, When the steering turn to right then the front wheel will turn to right (see the picture), When the steering turn to left then the front wheel will turn to left (see the picture).

Operation:

Adjust the dual rate of the steering by adjusting the D/R knob.

13. 02 THROTTLE CONTROL :



功能说明:

此功能是用来进行油门（速度）控制，当油门扣机往后打时车子会向前加速（如图），当油门扣机往前推时车子会时生刹车或加速后退（依据不同的调速器）如图）。

操作方法:

开机后，通过油门扣机进行前后运行的控制。

Function explanation:

This function is to control the throttle speed, When pull the throtte trigger back, Car will accelerate forward (see the picture), When push the throttle trigger, The car will put on the brakes or accelerates back (according to the different ESC) (see the picture).

Operation:

To control it by pushing and pulling back the throttle trigger after power on.

14. FAIL SAFE FUNCTION

失控保护功能说明

1. 功能说明

失控保护功能是对模型车或船进行失控保护，避免因失控造成损失。主要是对油门通道进行控制，当接收机接收不到控制信号时，接收机的油门通道将自运行到当初设定的值，以免误动作。

2. 设定方法

- a、将发射机开通电源进入工作状态。
- b、将接收机接通电源进入工作状态，此时信号灯恒亮。
- c、控制发射机的油门通道，使油门控制伺服器或调速器进入刹车或熄火状态，然后保持不动。
- d、此时将接收机的设定键（如图按下），此时接收机LED信号灯会闪烁，并在3秒左右停止。
- e、设定完成。

3. 测试

- a、将发射机打开进入工作状态。
- b、将接收机接通电源进入工作状态。
- c、将发射机关闭电源。
- d、此时可看到油门通道的伺服器便会自动进入设定状态的位置。
- e、以上动作如果可以完成表示设定OK

FAIL SAFE FUNCTION

1. Function

Failsafe aims to prevent out-of-control driving of RC Car or RC Boat. If the Receiver is not able to receive any signal, from the control to Throttle, the parameter of Throttle on Receiver will turn back to its original setting.

2. Setting

- a. Turn on the Transmitter switch;
- b. Turn on the Receiver switch, the LED will be lighting;
- c. Adjust Transmitter's Throttle, make the car/boat to stop or flameout, then keep still.
- d. Press the "Setting" button on Receiver (as the pic below), the LED will be flashing, then stop after 3seconds around, which means setting finished.

3. Testing

- a. Turn on the Transmitter switch;
- b. Turn on the Receiver switch;
- c. Turn off the Transmitter switch;
- d. Servo of Throttle will turn back to its original setting automatically;
- e. Setting is successful if above procedures finished completely.



15. SIMULATE FUNCTION

功能说明:

此功能用于电脑模拟，从而可通过电脑进行练习，及进行电脑模拟比赛。

操作方法:

1. 将本厂提供的电脑模拟连接线一端插入发射机的USB接口，另一端插入电脑的USB接口，
2. 打开发射机电源。
3. 启动VRC车模应用软件。
4. 按软件要求进行设定完成后便可进行电脑模拟了。

备注:

本公司提供的是VRC公司的免费软件，此软件只提供一条基本赛道和一个训练场。如需其它赛道请跟VRC公司联系。谢！

Function Introduction:

This function is for the virtual RC racing through the computer, you can practise the racing from the computer.

Operation Method:

1. Hook up the DSC port of your Transmitter to the USB adaptor (fs-sm100) and plug the USB adaptor into your PC notebook.
2. Turn on the Transmitter.
3. Open the VRC software.
4. Follow the on-screen instruction to set.

Remark:

The VRC software we provided is free which is offer only one basic track and training ground. If you need any other track, please contact VRC Company, thank you!



16. PACKAGING WITH CONTENT LIST

NO:	Model	Sum	Remarks
1	3 channel 2.4G transmitter (FS-GT3C) 3通2.4G发射 	1	
2	3channel 2.4G receiver (FS-GR3C) 3通2.4G接收 	1	
3	Manual 说明书 	1	CD
4	数据线 	1	
5	锂电池 	1	
6	Charger (FS-BC101) 充电器 	1	Optional 可选的
7	Servo (FS-S009) 伺服器 	2	Optional 可选的



Digital propotional radio control system



[Http://www.flysky-cn.com](http://www.flysky-cn.com)
Copy right 2008@flysky co., ltd